

# Virginia Supplement to the 2009 Manual on Uniform Traffic Control Devices

for Streets and Highways

2011 Edition

Revision 1 – September 30, 2013





**NOTICE:\***

Designers and users of this manual should go to the VDOT Supplement website [http://www.virginiadot.org/business/virginia\\_mutcd\\_supplement.asp](http://www.virginiadot.org/business/virginia_mutcd_supplement.asp) for the latest revisions and addendums to ensure that the most current version is being referenced.\*

The PDF files posted on the VDOT website constitute the most current and official version of the Virginia Supplement to the 2009\* Manual on Uniform Traffic Control Devices for Streets and Highways. The PDF files available on the VDOT website always take precedence over any potentially conflicting Virginia Supplement to the 2009\* MUTCD text or figures that may occur in previously printed versions.

For questions about the Virginia Supplement to the MUTCD, please contact the Supplement Team at: [VASupplement@vdot.virginia.gov](mailto:VASupplement@vdot.virginia.gov) \*



# VIRGINIA SUPPLEMENT TO THE MANUAL ON UNIFORM TRAFFIC CONTROL DEVICES

## INTRODUCTION

### Legal Authority of the MUTCD

Support:

- 01 The Manual on Uniform Traffic Control Devices for Streets and Highways (MUTCD) defines the standards used nationwide to install and maintain traffic control devices on all public streets, highways, bikeways, and private roads open to public traffic. It is published by the Federal Highway Administration (FHWA) under Title 23 of the Code of Federal Regulations (CFR), Part 655, Subpart F, and has been adopted by the FHWA as the national standard for designing, applying, and planning traffic control devices. As mandated by federal law, the Commonwealth Transportation Board (CTB) has adopted the MUTCD under authority granted by §§ 33.1-12 (3) and 46.2-830 of the Code of Virginia, as the official standard for designing, applying, and planning traffic control devices in the Commonwealth of Virginia.

### Purpose and Adoption of the Virginia Supplement to the MUTCD

Support:

- 02 The Virginia Supplement to the MUTCD (this Supplement), documents deviations from the MUTCD and adds Virginia-specific requirements. It contains standards, guidance, options, and support for the design, application, and placement of traffic control devices on roadways in the Commonwealth of Virginia. The National MUTCD contains Parts 1 through 9, and the Virginia Supplement to the MUTCD contains Parts 1, 2, 3, 4, 7, 8, and 9. Part 6 of the National MUTCD (Temporary Traffic Control) is entirely replaced by the “Virginia Work Area Protection Manual,” which is legally part of, but physically separate from this Supplement. There are no Virginia-specific changes to Part 5 of the National MUTCD; therefore the National MUTCD is in effect for all sections within Part 5. Any section within the Virginia Supplement to the MUTCD replaces the corresponding section of the National MUTCD, while the National MUTCD sections are still in effect for any section not in the Virginia Supplement.
- 03 The CTB also adopted this Supplement under the same authority. The provisions set forth in this Supplement are applicable to all roadways in the Commonwealth of Virginia maintained by the Virginia Department of Transportation (VDOT). Further, these provisions are applicable to all private roads open to public travel, such as those in

shopping centers, theme parks, airports, sports arenas, etc., in the Commonwealth of Virginia.

**Standard:**

- 04 **All localities shall, by Title 23 of the Code of Federal Regulations and by § 46.2-1312 of the Code of Virginia, follow the provisions of the Manual on Uniform Traffic Control Devices for Streets and Highways (MUTCD) as adopted by the FHWA and the CTB.**

**Support:**

- 05 Localities, as described in Paragraph 6, are excluded from the requirement to apply the provisions set forth in the Supplement.

**Option:**

- 06 Counties and independent cities and towns that maintain their own roadways may recognize the content of the Supplement and the “Virginia Work Area Protection Manual” as official guidance on the subject. A local jurisdiction may choose to adopt the Supplement and/or the “Virginia Work Area Protection Manual.” Adopting only one of the publications does not require that the locality adopt the other publication. If this Supplement is adopted by a local jurisdiction, then all references to the “State Traffic Engineer” within this document may be interpreted to mean the maintaining authority’s person responsible for traffic control devices.

**Standard:**

- 07 **The option in Paragraph 6 shall apply only to roadways under the maintenance of these localities and for private roads open to public travel within the boundaries of these localities.**

## How to Use the Virginia Supplement to the MUTCD

**Standard:**

- 08 **The MUTCD contains its own introduction which shall remain in force in addition to this Introduction for this Supplement.**
- 09 **Technical sections contained within the remainder of this Supplement shall replace the corresponding section in the MUTCD in its entirety.**
- 10 **If a section from the MUTCD is not contained within this Supplement, the section in the MUTCD shall remain in force.**

**Support:**

- 11 The Table of Contents for each Part of this Supplement contains a listing of each section in the MUTCD and additional sections added by VDOT. If a page number appears adjacent to a section title, that section can be found in this Supplement. If no page number appears adjacent to a section title, that section can be found in the MUTCD.
- 12 As in the MUTCD, Standard statements in this Supplement appear in bold text, Guidance statements appear in italicized text, and Options and Support statements appear in normal text. The definitions of Standard, Guidance, Option, and Support Statements can be found in Section 1A.13 of this Supplement. Additional information related to



- implementation of Standard statements can be found in Section 1A.09 of this Supplement.
- 13 Within this Supplement, blue text denotes Virginia-specific text added or modified by VDOT. Black text denotes FHWA content from the MUTCD which remains in force.
  - 14 The letter “V” from the VDOT logo appears in the left margin of any paragraph where blue Virginia-specific text related to technical content is present, and no blue text related to technical content is present in the previous paragraph. The exception to this is when a paragraph is divided into multiple sub paragraphs that expand over several pages and the blue Virginia-specific text related to technical content is confined to certain sub paragraphs. In these cases, the letter “V” from the VDOT logo will appear in the left margin of those subsections where blue Virginia-specific text related to technical content is present, and no blue Virginia-specific text related to technical content is present in the previous subsection.
  - 15 When content is elevated from Guidance in the MUTCD to a Standard in this Supplement, or an Option to Guidance, etc., all text will appear in blue.
  - 16 In some cases, text from the MUTCD is shown as blue ~~strikeout~~ text (e.g., ~~strikeout~~). When text is shown in ~~strikeout~~ format, it is no longer in force, and is shown for reference in cases where it is important for the reader to understand that a National MUTCD statement has been removed.
  - 17 All references in this Supplement to other sections include an annotation indicating whether that section can be found in this Supplement or in the MUTCD.
  - 18 Tables and Figures can be classified as:
    - A. Un-edited Tables/Figures from the MUTCD, which appear exactly as they appear in the MUTCD and with the same title.
    - B. Tables/Figures from the MUTCD with minor Virginia-specific edits or additions, which have “(VA)” appended to the Table or Figure title (i.e. Figure 2B-18(VA)). Blue text and the letter “V” from the VDOT logo denote the specific changes within the Figure or Table.
    - C. Tables/Figures created by VDOT for this Supplement, which appear with a blue title and the letter “V” from the VDOT logo adjacent to the title. Such Figures and Tables are numbered with the letter V in the figure number (i.e. Table 2C-V1). .
- Within each Section, all Tables and Figures referenced in that Section are included for ease of use of this Supplement.
- 19 Within the written body of this Supplement, references to Figures and Tables appear in blue text if the Figure or Table has any modifications to it (i.e. Figure 2B-18(VA) or Table 2C-V1). If an un-edited Table or Figure from the MUTCD is referenced in this Supplement, the reference is in black text as the reader may choose to examine the Table or Figure in either this Supplement or the MUTCD.

## Effective Date of the Virginia Supplement to the MUTCD

### Standard:

- 20 Except as provided in paragraph 21, the 2009 MUTCD and this Supplement shall be effective January 1, 2012. When a traffic control device is replaced through regular roadway maintenance on or after January 1, 2012, the replacement device shall be in conformance with the 2009 MUTCD and this Supplement with adopted revisions. New traffic control devices installed on or after January 1, 2012, shall be in conformance with the 2009 MUTCD and this Supplement with adopted revisions.

### Option:

- 21 All projects currently underway that are advertised before January 15, 2012 may be in conformance with the 2003 MUTCD with adopted revisions and previous version of the Virginia Supplement to the MUTCD.
- 22 Upon adoption by the CTB, the 2009 MUTCD and this Supplement may be applied prior to the required conformance date if desired.

### Standard:

- 23 Revision 1 of this Supplement shall be effective September 30, 2013 for daily operations, and January 1, 2014 for projects bid on or after January 1, 2014.\*

## **PART 1. GENERAL**

<b>CHAPTER 1A</b>	<b>General</b>	<b>PAGE</b>
Section 1A.01	Purpose of Traffic Control Devices	
Section 1A.02	Principles of Traffic Control Devices	
Section 1A.03	Design of Traffic Control Devices	
Section 1A.04	Placement and Operation of Traffic Control Devices	
Section 1A.05	Maintenance of Traffic Control Devices	
Section 1A.06	Uniformity of Traffic Control Devices	
Section 1A.07	Responsibility for Traffic Control Devices .....	1-1
Section 1A.08	Authority for Placement of Traffic Control Devices .....	1-2
Section 1A.09	Engineering Study and Engineering Judgment .....	1-3
Section 1A.10	Interpretations, Experimentations, Changes, and Interim Approvals .....	1-4
Section 1A.11	Relation to Other Publications .....	1-11
Section 1A.12	Color Code	
Section 1A.13	Definitions of Headings, Words, and Phrases in this Manual .....	1-13
Section 1A.14	Meanings of Acronyms and Abbreviations in this Manual .....	1-35
Section 1A.15	Abbreviations Used on Traffic Control Devices	

# PART 1

## GENERAL

### CHAPTER 1A. GENERAL

#### Section 1A.07 Responsibility for Traffic Control Devices

**Standard:**

- 01 **The responsibility for the design, placement, operation, maintenance, and uniformity of traffic control devices shall rest with the public agency or the official having jurisdiction, or, in the case of private roads open to public travel, with the private owner or private official having jurisdiction. 23 CFR 655.603 adopts the MUTCD as the national standard for all traffic control devices installed on any street, highway, bikeway, or private road open to public travel (see definition in [Section 1A.13 of this Supplement](#)). When a State or other Federal agency manual or supplement is required, that manual or supplement shall be in substantial conformance with the National MUTCD.**
- 02 **23 CFR 655.603 also states that traffic control devices on all streets, highways, bikeways, and private roads open to public travel in each State shall be in substantial conformance with standards issued or endorsed by the Federal Highway Administrator.**

**Support:**

- 03 The Introduction of the [MUTCD](#) contains information regarding the meaning of substantial conformance and the applicability of the [MUTCD](#) to private roads open to public travel.
- 04 [The Introduction to this Supplement contains information regarding the applicability in this Supplement to streets, highways, bikeways, and private roads open to public travel within the Commonwealth of Virginia.](#)
- 05 The "Uniform Vehicle Code" (see [Section 1A.11 of this Supplement](#)) has the following provision in Section 15-104 for the adoption of a uniform manual:
  - a. "The [State Highway Agency] shall adopt a manual and specification for a uniform system of traffic control devices consistent with the provisions of this code for use upon highways within this State. Such uniform system shall correlate with and so far as possible conform to the system set forth in the most recent edition of the Manual on Uniform Traffic Control Devices for Streets and Highways, and other standards issued or endorsed by the Federal Highway Administrator."
  - b. "The Manual adopted pursuant to subsection (a) shall have the force and effect of law."
- 06 All States have officially adopted the National MUTCD either in its entirety, with supplemental provisions, or as a separate published document.





*Guidance:*

- 07 *These individual State manuals or supplements should be reviewed for specific provisions relating to that State.*

*Support:*

- 08 The National MUTCD has also been adopted by the National Park Service, the U.S. Forest Service, the U.S. Military Command, the Bureau of Indian Affairs, the Bureau of Land Management, and the U.S. Fish and Wildlife Service.

*Guidance:*

- 09 *States should adopt Section 15-116 of the "Uniform Vehicle Code," which states that, "No person shall install or maintain in any area of private property used by the public any sign, signal, marking, or other device intended to regulate, warn, or guide traffic unless it conforms with the State manual and specifications adopted under Section 15-104."*

## **Section 1A.08 Authority for Placement of Traffic Control Devices**

**Standard:**

- 01 **Traffic control devices, advertisements, announcements, and other signs or messages within the highway right-of-way shall be placed only as authorized by a public authority or the official having jurisdiction, or, in the case of private roads open to public travel, by the private owner or private official having jurisdiction, for the purpose of regulating, warning, or guiding traffic.**
- 02 **When the public agency or the official having jurisdiction over a street or highway, or, in the case of private roads open to public travel, the private owner or private official having jurisdiction, has granted proper authority, others such as contractors and public utility companies shall be permitted to install **approved** temporary traffic control devices in temporary traffic control zones. **Such temporary traffic control devices shall conform in design, application and placement with the Standards of the "Virginia Work Area Protection Manual" (most current edition with updates).****

*Guidance:*

- 03 *Any unauthorized traffic control device or other sign or message placed on the highway right-of-way by a private organization or individual constitutes a public nuisance and should be removed. All unofficial or nonessential traffic control devices, signs, or messages should be removed.*

**Standard:**

- 04 **All regulatory traffic control devices shall be supported by laws, ordinances, or regulations.**



**Support:**

- 05 Provisions of [the MUTCD and this Supplement](#) are based upon the concept that effective traffic control depends upon both appropriate application of the devices and reasonable enforcement of the regulations.
- 06 Although some highway design features, such as curbs, median barriers, guardrails, speed humps or tables, and textured pavement, have a significant impact on traffic operations and safety, they are not considered to be traffic control devices and provisions regarding their design and use are generally not included [in the MUTCD or this Supplement](#).
- 07 Certain types of signs and other devices that do not have any traffic control purpose are sometimes placed within the highway right-of-way by or with the permission of the public agency or the official having jurisdiction over the street or highway. Most of these signs and other devices are not intended for use by road users in general, and their message is only important to individuals who have been instructed in their meanings. These signs and other devices are not considered to be traffic control devices and provisions regarding their design and use are not included in the MUTCD or this Supplement. Among these signs and other devices are the following:
  - A. Devices whose purpose is to assist highway maintenance personnel. Examples include markers to guide snowplow operators, devices that identify culvert and drop inlet locations, and devices that precisely identify highway locations for maintenance or mowing purposes.
  - B. Devices whose purpose is to assist fire or law enforcement personnel. Examples include markers that identify fire hydrant locations, signs that identify fire or water district boundaries, speed measurement pavement markings, small indicator lights to assist in enforcement of red light violations, and photo enforcement systems.
  - C. Devices whose purpose is to assist utility company personnel and highway contractors, such as markers that identify underground utility locations.
  - D. Signs posting local non-traffic ordinances.
  - E. Signs giving civic organization meeting information.

**Standard:**

- 08 **Signs and other devices that do not have any traffic control purpose that are placed within the highway right-of-way shall not be located where they will interfere with, or detract from, traffic control devices.**

## **Section 1A.09 Engineering Study and Engineering Judgment**

**Support:**

- 01 Definitions of an engineering study and engineering judgment are contained in [Section 1A.13 of this Supplement](#).

**Standard:**

- 02 **The MUTCD and this Supplement describe the application of traffic control devices, but shall not be a legal requirement for their installation.**

*Guidance:*

- 03 *The decision to use or not use a particular traffic control device at a particular location should be made on the basis of engineering study and the application of engineering judgment. Thus, while the MUTCD and this Supplement provide Standards, Guidance, and Options for design and application of traffic control devices, the MUTCD and this Supplement should not be considered a substitute for engineering study and the application of engineering judgment. Engineering judgment should be exercised in the selection and application of traffic control devices, as well as in the location and design of the roads and streets that the devices complement. Jurisdictions with responsibility for traffic control that do not have professional engineers on their staffs should seek professional engineering assistance from others, such as a professional traffic engineering consultant.*
- 04 *An engineering study should be the basis for a decision to deviate from a Standard (see definition in Section 1A.13 of this Supplement).*
- 05 *Early in the processes of location and design of roads and streets, engineers should coordinate such location and design with the design and placement of the traffic control devices to be used with such roads and streets.*
- 06 *Jurisdictions, or owners of private roads open to public travel, with responsibility for traffic control that do not have engineers on their staffs who are trained and/or experienced in traffic control devices should seek engineering assistance from others, such as the State transportation agency, their county, a nearby large city, or a traffic engineering consultant.*

**Support:**

- 07 As part of the Federal-aid Program, each State is required to have a Local Technology Assistance Program (LTAP) and to provide technical assistance to local highway agencies. Requisite technical training in the application of the principles of the MUTCD is available from the State's Local Technology Assistance Program for needed engineering guidance and assistance.

## **Section 1A.10 Interpretations, Experimentations, Changes, and Interim Approvals**

**Standard:**

- 01 **Design, application, and placement of traffic control devices other than those adopted in this Manual shall be prohibited unless the provisions of this Section are followed.**

**Support:**

- 02 Continuing advances in technology will produce changes in the highway, vehicle, and road user proficiency; therefore, portions of the system of traffic control devices in this



Manual will require updating. In addition, unique situations often arise for device applications that might require interpretation or clarification of this Manual. It is important to have a procedure for recognizing these developments and for introducing new ideas and modifications into the system.

**Standard:**

- 03 **Except as provided in Paragraph 4, requests for any interpretation, permission to experiment, interim approval, or change shall be submitted electronically to the Federal Highway Administration (FHWA), Office of Transportation Operations, MUTCD team, at the following e-mail address: MUTCDofficialrequest@dot.gov.**

**Option:**

- 04 If electronic submittal is not possible, requests for interpretations, permission to experiment, interim approvals, or changes may instead be mailed to the Office of Transportation Operations, HOTO-1, Federal Highway Administration, 1200 New Jersey Avenue, SE, Washington, DC 20590.

**Support:**

- 05 Communications regarding other MUTCD matters that are not related to official requests will receive quicker attention if they are submitted electronically to the MUTCD Team Leader or to the appropriate individual MUTCD team member. Their e-mail addresses are available through the links contained on the "Who's Who" page on the MUTCD website at <http://mutcd.fhwa.dot.gov/team.htm>.
- 06 An interpretation includes a consideration of the application and operation of standard traffic control devices, official meanings of standard traffic control devices, or the variations from standard device designs.

**Guidance:**

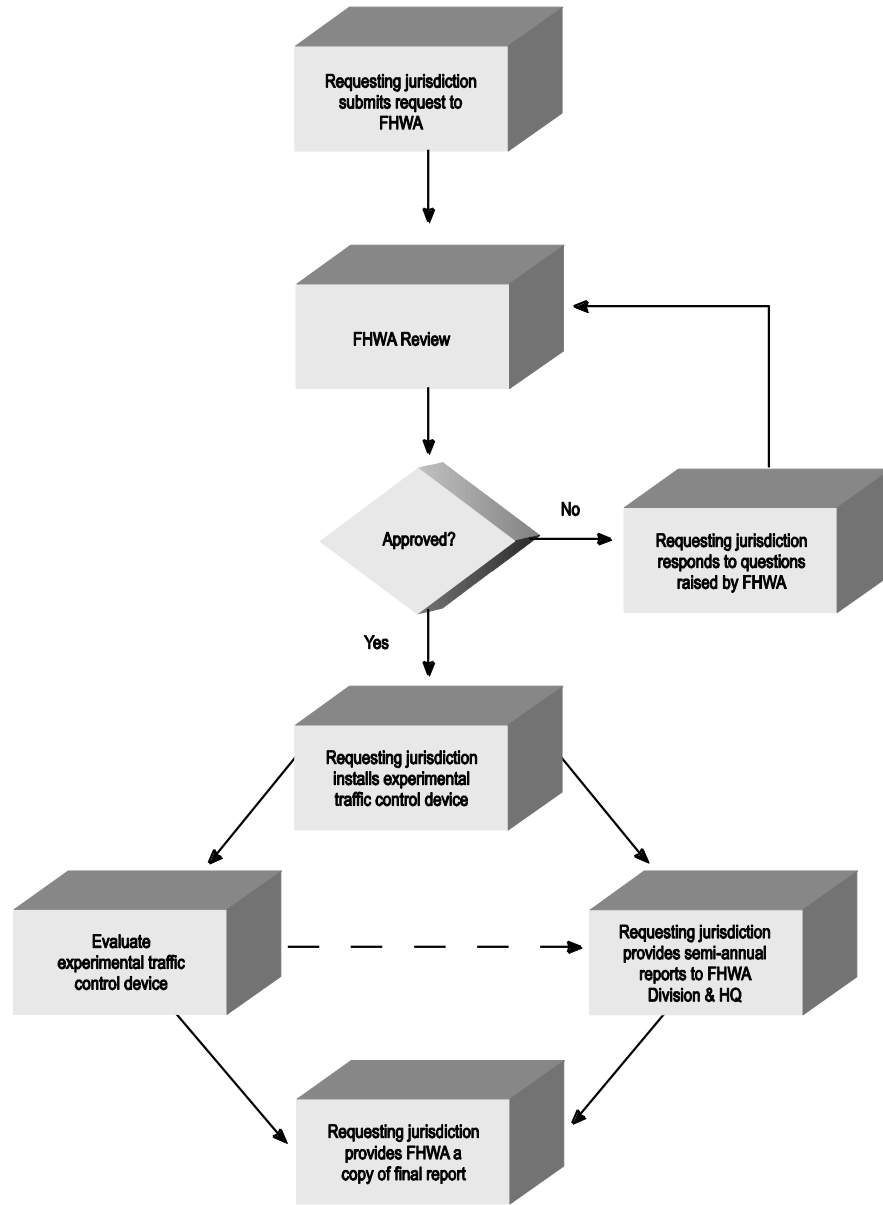
- 07 *Requests for an interpretation of this Manual should contain the following information:*
- A. *A concise statement of the interpretation being sought;*
  - B. *A description of the condition that provoked the need for an interpretation;*
  - C. *Any illustration that would be helpful to understand the request; and*
  - D. *Any supporting research data that is pertinent to the item to be interpreted.*

**Support:**

- 08 Requests to experiment include consideration of field deployment for the purpose of testing or evaluating a new traffic control device, its application or manner of use, or a provision not specifically described in this Manual.
- 09 A request for permission to experiment will be considered only when submitted by the public agency or toll facility operator responsible for the operation of the road or street on which the experiment is to take place. For a private road open to public travel, the request will be considered only if it is submitted by the private owner or private official having jurisdiction.
- 10 A diagram indicating the process for experimenting with traffic control devices is shown in [Figure 1A-1\(VA\) in this Supplement](#).



**Figure 1A-1(VA) Process for Requesting and Conducting Experimentations for New Traffic Control Devices**



Note: For experimentation of new regulatory and warning signs, the request shall be submitted to and approved by the Office of the State Traffic Engineer prior to submission to FHWA 

*Guidance:*

- 11 *The request for permission to experiment should contain the following:*
  - A. *A statement indicating the nature of the problem.*
  - B. *A description of the proposed change to the traffic control device or application of the traffic control device, how it was developed, the manner in which it deviates from the standard, and how it is expected to be an improvement over existing standards.*
  - C. *Any illustration that would be helpful to understand the traffic control device or use of the traffic control device.*
  - D. *Any supporting data explaining how the traffic control device was developed, if it has been tried, in what ways it was found to be adequate or inadequate, and how this choice of device or application was derived.*
  - E. *A legally binding statement certifying that the concept of the traffic control device is not protected by a patent or copyright. (An example of a traffic control device concept would be countdown pedestrian signals in general. Ordinarily an entire general concept would not be patented or copyrighted, but if it were it would not be acceptable for experimentation unless the patent or copyright owner signs a waiver of rights acceptable to the FHWA. An example of a patented or copyrighted specific device within the general concept of countdown pedestrian signals would be a manufacturer's design for its specific brand of countdown signal, including the design details of the housing or electronics that are unique to that manufacturer's product. As long as the general concept is not patented or copyrighted, it is acceptable for experimentation to incorporate the use of one or more patented devices of one or several manufacturers.)*
  - F. *The time period and location(s) of the experiment.*
  - G. *A detailed research or evaluation plan that must provide for close monitoring of the experimentation, especially in the early stages of its field implementation. The evaluation plan should include before and after studies as well as quantitative data describing the performance of the experimental device.*
  - H. *An agreement to restore the site of the experiment to a condition that complies with the provisions of this Manual within 3 months following the end of the time period of the experiment. This agreement must also provide that the agency sponsoring the experimentation will terminate the experimentation at any time that it determines significant safety concerns are directly or indirectly attributable to the experimentation. The FHWA's Office of Transportation Operations has the right to terminate approval of the experimentation at any time if there is an indication of safety concerns. If, as a result of the experimentation, a request is made that this Manual be changed to include the device or application being experimented with, the device or application will be permitted to remain in place until an official rulemaking action has occurred.*
  - I. *An agreement to provide semi-annual progress reports for the duration of the experimentation, and an agreement to provide a copy of the final results of the experimentation to the FHWA's Office of Transportation Operations within 3 months*

*following completion of the experimentation. The FHWA's Office of Transportation Operations has the right to terminate approval of the experimentation if reports are not provided in accordance with this schedule.*

**Support:**

- 12 A change includes consideration of a new device to replace a present standard device, an additional device to be added to the list of standard devices, or a revision to a traffic control device application or placement criteria.

*Guidance:*

- 13 *Requests for a change to this Manual should contain the following information:*
- A. A statement indicating what change is proposed;*
  - B. Any illustration that would be helpful to understand the request; and*
  - C. Any supporting research data that is pertinent to the item to be reviewed.*

**Support:**

- 14 Interim approval allows interim use, pending official rulemaking, of a new traffic control device, a revision to the application or manner of use of an existing traffic control device, or a provision not specifically described in this Manual. The FHWA issues an Interim Approval by official memorandum signed by the Associate Administrator for Operations and posts this memorandum on the MUTCD website. The issuance by FHWA of an interim approval will typically result in the traffic control device or application being placed into the next scheduled rulemaking process for revisions to this Manual.
- 15 Interim approval is considered based on the results of successful experimentation, results of analytical or laboratory studies, and/or review of non-U.S. experience with a traffic control device or application. Interim approval considerations include an assessment of relative risks, benefits, costs, impacts, and other factors.
- 16 Interim approval allows for optional use of a traffic control device or application and does not create a new mandate or recommendation for use. Interim approval includes conditions that jurisdictions agree to comply with in order to use the traffic control device or application until an official rulemaking action has occurred.

**Standard:**

- 17 **A jurisdiction, toll facility operator, or owner of a private road open to public travel that desires to use a traffic control device for which FHWA has issued an interim approval shall request permission from FHWA.**

*Guidance:*

- 18 *The request for permission to place a traffic control device under an interim approval should contain the following:*
- A. A description of where the device will be used, such as a list of specific locations or highway segments or types of situations, or a statement of the intent to use the device jurisdiction-wide;*
  - B. An agreement to abide by the specific conditions for use of the device as contained in the FHWA's interim approval document;*

C. *An agreement to maintain and continually update a list of locations where the device has been installed; and*

D. *An agreement to:*

1. *Restore the site(s) of the interim approval to a condition that complies with the provisions in this Manual within 3 months following the issuance of a final rule on this traffic control device; and*
2. *Terminate use of the device or application installed under the interim approval at any time that it determines significant safety concerns are directly or indirectly attributable to the device or application. The FHWA's Office of Transportation Operations has the right to terminate the interim approval at any time if there is an indication of safety concerns.*

Option:

- 19 A State may submit a request for the use of a device under interim approval for all jurisdictions in that State, as long as the request contains the information listed in Paragraph 18.

Guidance:

- 20 *A local jurisdiction, toll facility operator, or owner of a private road open to public travel using a traffic control device or application under an interim approval that was granted by FHWA either directly or on a statewide basis based on the State's request should inform the State of the locations of such use.*
- 21 *A local jurisdiction, toll facility operator, or owner of a private road open to public travel that is requesting permission to experiment or permission to use a device or application under an interim approval should first check for any State laws and/or directives covering the application of the MUTCD provisions that might exist in their State.*

Option:

- 22 A device or application installed under an interim approval may remain in place, under the conditions established in the interim approval, until an official rulemaking action has occurred.

Support:

- 23 A diagram indicating the process for incorporating new traffic control devices into this Manual is shown in [Figure 1A-2\(VA\) in this Supplement](#).
- 24 For additional information concerning interpretations, experimentation, changes, or interim approvals, visit the MUTCD website at <http://mutcd.fhwa.dot.gov>.

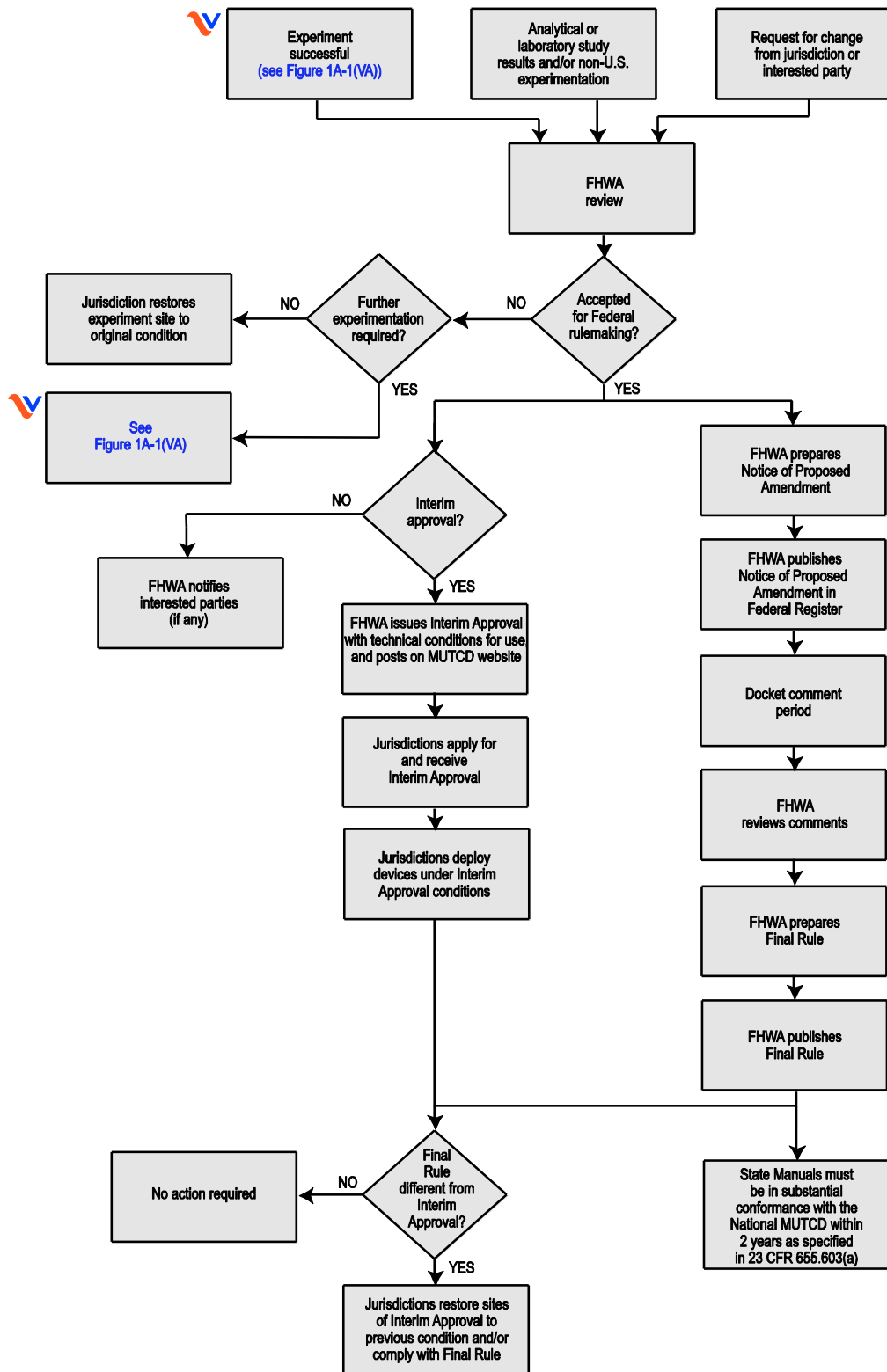
**Standard:**

- 25 **Any proposed or modified permanent Regulatory or Warning signs not in the MUTCD or this Supplement shall be submitted for review and approval by VDOT's Office of the State Traffic Engineer. Signs shall not be fabricated or installed prior to approval. This requirement shall apply whether or not submission to FHWA is required.**






### Figure 1A-2(VA) Process for Incorporating New Traffic Control Devices into the MUTCD



## Section 1A.11 Relation to Other Publications

### Standard:

- 
- 01 **To the extent that they are incorporated by specific reference, the latest editions of the following publications, or those editions specifically noted, shall be a part of this Manual: "Standard Highway Signs and Markings" book (FHWA); and "Color Specifications for Retroreflective Sign and Pavement Marking Materials" (appendix to subpart F of Part 655 of Title 23 of the Code of Federal Regulations).**
  - 02 **Signs referenced in this Supplement shall be designed and fabricated according to the sign layout specifications in the latest edition of the "Virginia Standard Highway Signs" book. See Appendix A of this Supplement for a link to the latest edition.**
  - 03 **While the "Virginia Work Area Protection Manual" is adopted under the umbrella of the Virginia Supplement to the MUTCD, the engineering application of the two publications should be separate. The visual format and rules for use outlined in the Introduction for this publication only apply to the Parts included in this publication (Parts 1, 2, 3, 4, 7, 8, and 9, exclusive of Part 6). Part 6, the "Virginia Work Area Protection Manual," is applied in a separate and different manner as defined therein.**

### Support:

- 04 The "Standard Highway Signs and Markings" book includes standard alphabets and symbols and arrows for signs and pavement markings.
- 05 For information about the publications mentioned in Paragraph 1, visit the Federal Highway Administration's MUTCD website at <http://mutcd.fhwa.dot.gov>, or write to the FHWA, 1200 New Jersey Avenue, SE, HOTO, Washington, DC 20590.
- 06 Other publications that are useful sources of information with respect to the use of this Manual are listed in this paragraph. See Addresses in this Manual for ordering information for the following publications (later editions might also be available as useful sources of information):
  1. "AAA School Safety Patrol Operations Manual," 2006 Edition (American Automobile Association—AAA)
  2. "A Policy on Geometric Design of Highways and Streets," 2004 Edition (American Association of State Highway and Transportation Officials—AASHTO)
  3. "Guide for the Development of Bicycle Facilities," 1999 Edition (AASHTO)
  4. "Guide for the Planning, Design, and Operation of Pedestrian Facilities," 2004 Edition (AASHTO)
  5. "Guide to Metric Conversion," 1993 Edition (AASHTO)
  6. "Guidelines for the Selection of Supplemental Guide Signs for Traffic Generators Adjacent to Freeways," 4th Edition/Guide Signs, Part II: Guidelines for Airport Guide Signing/Guide Signs, Part III: List of Control Cities for Use in Guide Signs on Interstate Highways," Item Code: GSGLC-4, 2001 Edition (AASHTO)
  7. "Roadside Design Guide," 2006 Edition (AASHTO)
  8. "Standard Specifications for Movable Highway Bridges," 1988 Edition (AASHTO)

9. "Traffic Engineering Metric Conversion Folders—Addendum to the Guide to Metric Conversion," 1993 Edition (AASHTO)
10. "2009 AREMA Communications & Signals Manual," (American Railway Engineering & Maintenance-of-Way Association—AREMA)
11. "Changeable Message Sign Operation and Messaging Handbook (FHWA-OP-03-070)," 2004 Edition (Federal Highway Administration—FHWA)
12. "Designing Sidewalks and Trails for Access—Part 2—Best Practices Design Guide (FHWA-EP-01-027)," 2001 Edition (FHWA)
13. "Federal-Aid Highway Program Guidance on High Occupancy Vehicle (HOV) Lanes," 2001 (FHWA)
14. "Maintaining Traffic Sign Retroreflectivity," 2007 Edition (FHWA)
15. "Railroad-Highway Grade Crossing Handbook—Revised Second Edition (FHWA-SA-07-010)," 2007 Edition (FHWA)
16. "Ramp Management and Control Handbook (FHWA-HOP-06-001)," 2006 Edition (FHWA)
17. "Roundabouts-An Informational Guide (FHWA-RD-00-067)," 2000 Edition (FHWA)
18. "Signal Timing Manual (FHWA-HOP-08-024)," 2008 Edition (FHWA)
19. "Signalized Intersections: an Informational Guide (FHWA-HRT-04-091)," 2004 Edition (FHWA)
20. "Travel Better, Travel Longer: A Pocket Guide to Improving Traffic Control and Mobility for Our Older Population (FHWA-OP-03-098)," 2003 Edition (FHWA)
21. "Practice for Roadway Lighting," RP-8, 2001 (Illuminating Engineering Society—IES)
22. "Safety Guide for the Prevention of Radio Frequency Radiation Hazards in the Use of Commercial Electric Detonators (Blasting Caps)," Safety Library Publication No. 20, July 2001 Edition (Institute of Makers of Explosives)
23. "American National Standard for High-Visibility Public Safety Vests," (ANSI/ISEA 207-2006), 2006 Edition (International Safety Equipment Association—ISEA)
24. "American National Standard for High-Visibility Safety Apparel and Headwear," (ANSI/ISEA 107-2004), 2004 Edition (ISEA)
25. "Manual of Traffic Signal Design," 1998 Edition (Institute of Transportation Engineers—ITE)
26. "Manual of Transportation Engineering Studies," 1994 Edition (ITE)
27. "Pedestrian Traffic Control Signal Indications," Part 1—1985 Edition; Part 2 (LED Pedestrian Traffic Signal Modules)—2004 Edition (ITE)
28. "Preemption of Traffic Signals Near Railroad Crossings," 2006 Edition (ITE)
29. "Purchase Specification for Flashing and Steady Burn Warning Lights," 1981 Edition (ITE)
30. "Traffic Control Devices Handbook," 2001 Edition (ITE)
31. "Traffic Detector Handbook," 1991 Edition (ITE)
32. "Traffic Engineering Handbook," 2009 Edition (ITE)

33. "Traffic Signal Lamps," 1980 Edition (ITE)
34. "Vehicle Traffic Control Signal Heads," Part 1—1985 Edition; Part 2 (LED Circular Signal Supplement)—2005 Edition; Part 3 (LED Vehicular Arrow Traffic Signal Supplement)—2004 Edition (ITE)
35. "Uniform Vehicle Code (UVC) and Model Traffic Ordinance," 2000 Edition (National Committee on Uniform Traffic Laws and Ordinances—NCUTLO)
36. "NEMA Standards Publication TS 4-2005 Hardware Standards for Dynamic Message Signs (DMS) With NTCIP Requirements," 2005 Edition (National Electrical Manufacturers Association—NEMA)
37. "Occupational Safety and Health Administration Regulations (Standards – 29 CFR), General Safety and Health Provisions – 1926.20," amended June 30, 1993 (Occupational Safety and Health Administration—OSHA)
38. "Accessible Pedestrian Signals—A Guide to Best Practices (NCHRP Web-Only Document 117A)," 2008 Edition (Transportation Research Board—TRB)
39. "Guidelines for Accessible Pedestrian Signals (NCHRP Web-Only Document 117B)," 2008 Edition (TRB)
40. "Highway Capacity Manual," 2000 Edition (TRB)
41. "Recommended Procedures for the Safety Performance Evaluation of Highway Features," (NCHRP Report 350), 1993 Edition (TRB)
42. "The Americans with Disabilities Act Accessibility Guidelines for Buildings and Facilities (ADAAG)," July 1998 Edition (The U.S. Access Board)



07 See Appendix A of this Supplement for additional Virginia specific publications.

## **Section 1A.13 Definitions of Headings, Words, and Phrases in this Manual**

### **Standard:**

01 When used in **the MUTCD and this Supplement**, the text headings of Standard, Guidance, Option, and Support shall be defined as follows:




- A. **Standard**—a statement of required, mandatory, or specifically prohibitive practice regarding a traffic control device. All Standard statements are labeled, and the text appears in bold type. The verb "shall" is typically used. The verbs "should" and "may" are not used in Standard statements. Standard statements are sometimes modified by Options. ~~Standard statements shall not be modified or compromised based only on engineering judgment.~~ Section 1A.09 of this Supplement contains additional Guidance related to the application of Standard statements.
- B. **Guidance**—a statement of recommended, but not mandatory, practice in typical situations, with deviations allowed if engineering judgment or engineering study indicates the deviation to be appropriate. All Guidance statements are labeled, and the text appears in unbold **italicized** type. The verb "should" is typically used.

The verbs "shall" and "may" are not used in Guidance statements. Guidance statements are sometimes modified by Options.

- C. **Option**—a statement of practice that is a permissive condition and carries no requirement or recommendation. Option statements sometime contain allowable modifications to a Standard or Guidance statement. All Option statements are labeled, and the text appears in unbold type. The verb "may" is typically used. The verbs "shall" and "should" are not used in Option statements.
- D. **Support**—an informational statement that does not convey any degree of mandate, recommendation, authorization, prohibition, or enforceable condition. Support statements are labeled, and the text appears in unbold type. The verbs "shall," "should," and "may" are not used in Support statements.

Support:

-  02 As indicated in Section 1A.09 of this Supplement, Paragraph 3, the decision to use a particular device at a particular location is typically made on the basis of an engineering study of the location. Thus, while this Supplement provides standards for design and application of traffic control devices, this Supplement is not a substitute for engineering judgment. It is the intent that the provisions of this Supplement be standards for traffic control devices installation, but not a legal requirement for installation.

**Standard:**

- 03 **Unless otherwise defined in this Section, or in other Parts of the MUTCD or this Supplement, words or phrases shall have the meaning(s) as defined in the most recent editions of the "Uniform Vehicle Code," "AASHTO Transportation Glossary (Highway Definitions)," and other publications mentioned in Section 1A.11 of this Supplement.**
- 04 **The following words and phrases, when used in the MUTCD and this Supplement, shall have the following meanings:**
1. **Accessible Pedestrian Signal**—a device that communicates information about pedestrian signal timing in non-visual format such as audible tones, speech messages, and/or vibrating surfaces.
  2. **Accessible Pedestrian Signal Detector**—a device designated to assist the pedestrian who has visual or physical disabilities in activating the pedestrian phase.
  3. **Active Grade Crossing Warning System**—the flashing-light signals, with or without warning gates, together with the necessary control equipment used to inform road users of the approach or presence of rail traffic at grade crossings.
  4. **Actuated Operation**—a type of traffic control signal operation in which some or all signal phases are operated on the basis of actuation.
  5. **Actuation**—initiation of a change in or extension of a traffic signal phase through the operation of any type of detector.
  6. **Advance Preemption**—the notification of approaching rail traffic that is forwarded to the highway traffic signal controller unit or assembly by the railroad or light rail transit equipment in advance of the activation of the railroad or light rail transit warning devices.

7. **Advance Preemption Time**—the period of time that is the difference between the required maximum highway traffic signal preemption time and the activation of the railroad or light rail transit warning devices.
8. **Advisory Speed**—a recommended speed for all vehicles operating on a section of highway and based on the highway design, operating characteristics, and conditions.
9. **Alley**—a street or highway intended to provide access to the rear or side of lots or buildings in urban areas and not intended for the purpose of through vehicular traffic.
10. **Altered Speed Zone**—a speed limit, other than a statutory speed limit, that is based upon an engineering study.
11. **Approach**—all lanes of traffic moving toward an intersection or a midblock location from one direction, including any adjacent parking lane(s).
12. **Arterial Highway (Street)**—a general term denoting a highway primarily used by through traffic, usually on a continuous route or a highway designated as part of an arterial system.
13. **Attended Lane (Manual Lane)**—a toll lane adjacent to a toll booth occupied by a human toll collector who makes change, issues receipts, and perform other toll-related functions. Attended lanes at toll plazas typically require vehicles to stop to pay the toll.
14. **Automatic Lane**—see Exact Change Lane.
15. **Average Annual Daily Traffic (AADT)**—the total volume of traffic passing a point or segment of a highway facility in both directions for one year divided by the number of days in the year. Normally, periodic daily traffic volumes are adjusted for hours of the day counted, days of the week, and seasons of the year to arrive at average annual daily traffic.
16. **Average Daily Traffic (ADT)**—the average 24 hour volume, being the total volume during a stated period divided by the number of days in that period. Normally, this would be periodic daily traffic volumes over several days, not adjusted for days of the week or seasons of the year.
17. **Average Day**—a day representing traffic volumes normally and repeatedly found at a location, typically a weekday when volumes are influenced by employment or a weekend day when volumes are influenced by entertainment or recreation.
18. **Backplate**—see Signal Backplate.
19. **Barrier-Separated Lane**—a preferential lane or other special purpose lane that is separated from the adjacent general-purpose lane(s) by a physical barrier.
20. **Beacon**—a highway traffic signal with one or more signal sections that operates in a flashing mode.
21. **Bicycle**—a pedal-powered vehicle upon which the human operator sits.
22. **Bicycle Facilities**—a general term denoting improvements and provisions that accommodate or encourage bicycling, including parking and storage facilities, and shared roadways not specifically defined for bicycle use.

23. **Bicycle Lane**—a portion of a roadway that has been designated for preferential or exclusive use by bicyclists by pavement markings and, if used, signs.
24. **Bikeway**—a generic term for any road, street, path, or way that in some manner is specifically designated for bicycle travel, regardless of whether such facilities are designated for the exclusive use of bicycles or are to be shared with other transportation modes.
25. **Buffer-Separated Lane**—a preferential lane or other special purpose lane that is separated from the adjacent general-purpose lane(s) by a pattern of standard longitudinal pavement markings that is wider than a normal or wide lane line marking. The buffer area might include rumble strips, textured pavement, or channelizing devices such as tubular markers or traversable curbs, but does not include a physical barrier.
26. **Cantilevered Signal Structure**—a structure, also referred to as a mast arm, that is rigidly attached to a vertical pole and is used to provide overhead support of highway traffic signal faces or grade crossing signal units.
27. **Center Line Markings**—the yellow pavement marking line(s) that delineates the separation of traffic lanes that have opposite directions of travel on a roadway. These markings need not be at the geometrical center of the pavement.
28. **Changeable Message Sign**—a sign that is capable of displaying more than one message (one of which might be a "blank" display), changeable manually, by remote control, or by automatic control. Electronic-display changeable message signs are referred to as Dynamic Message Signs in the National Intelligent Transportation Systems (ITS) Architecture and are referred to as Variable Message Signs in the National Electrical Manufacturers Association (NEMA) standards publication.
29. **Channelizing Line Markings**—a wide or double solid white line used to form islands where traffic in the same direction of travel is permitted on both sides of the island.
30. **Circular Intersection**—an intersection that has an island, generally circular in design, located in the center of the intersection where traffic passes to the right of the island. Circular intersections include roundabouts, rotaries, and traffic circles.
31. **Circulatory Roadway**—the roadway within a circular intersection on which traffic travels in a counterclockwise direction around an island in the center of the circular intersection.
32. **Clear Storage Distance**—when used in Part 8, the distance available for vehicle storage measured between 6 feet from the rail nearest the intersection to the intersection stop line or the normal stopping point on the highway. At skewed grade crossings and intersections, the 6-foot distance shall be measured perpendicular to the nearest rail either along the center line or edge line of the highway, as appropriate, to obtain the shorter distance. Where exit gates are used, the distance available for vehicle storage is measured from the point where the rear of the vehicle would be clear of the exit gate arm. In cases where the exit gate arm is parallel to the track(s) and is not perpendicular to the

highway, the distance is measured either along the center line or edge line of the highway, as appropriate, to obtain the shorter distance.

33. **Clear Zone**—the total roadside border area, starting at the edge of the traveled way, that is available for an errant driver to stop or regain control of a vehicle. This area might consist of a shoulder, a recoverable slope, and/or a non-recoverable, traversable slope with a clear run-out area at its toe.
34. **Collector Highway**—a term denoting a highway that in rural areas connects small towns and local highways to arterial highways, and in urban areas provides land access and traffic circulation within residential, commercial, and business areas and connects local highways to the arterial highways.
35. **Concurrent Flow Preferential Lane**—a preferential lane that is operated in the same direction as the adjacent mixed flow lanes, separated from the adjacent general-purpose freeway lanes by a standard lane stripe, painted buffer, or barrier.
36. **Conflict Monitor**—a device used to detect and respond to improper or conflicting signal indications and improper operating voltages in a traffic controller assembly.
37. **Constant Warning Time Detection**—a means of detecting rail traffic that provides relatively uniform warning time for the approach of trains or light rail transit traffic that are not accelerating or decelerating after being detected.
38. **Contiguous Lane**—a lane, preferential or otherwise, that is separated from the adjacent lane(s) only by a normal or wide lane line marking.
39. **Controller Assembly**—a complete electrical device mounted in a cabinet for controlling the operation of a highway traffic signal.
40. **Controller Unit**—that part of a controller assembly that is devoted to the selection and timing of the display of signal indications.
41. **Conventional Road**—a street or highway other than a low-volume road (as defined in Section 5A.01 of the MUTCD), expressway, or freeway.
42. **Counter-Flow Lane**—a lane operating in a direction opposite to the normal flow of traffic designated for peak direction of travel during at least a portion of the day. Counter-flow lanes are usually separated from the off-peak direction lanes by tubular markers or other flexible channelizing devices, temporary lane separators, or movable or permanent barrier.
43. **Crashworthy**—a characteristic of a roadside appurtenance that has been successfully crash tested in accordance with a national standard such as the National Cooperative Highway Research Program Report 350, "Recommended Procedures for the Safety Performance Evaluation of Highway Features."
44. **Crosswalk**—(a) that part of a roadway at an intersection included within the connections of the lateral lines of the sidewalks on opposite sides of the highway measured from the curbs or in the absence of curbs, from the edges of the traversable roadway, and in the absence of a sidewalk on one side of the roadway, the part of a roadway included within the extension of the lateral lines of the sidewalk at right angles to the center line; (b) any portion of a roadway at



an intersection or elsewhere distinctly indicated as a pedestrian crossing by pavement marking lines on the surface, which might be supplemented by contrasting pavement texture, style, or color.

45. **Crosswalk Lines**—white pavement marking lines that identify a crosswalk.
46. **Cycle Length**—the time required for one complete sequence of signal indications.
47. **Dark Mode**—the lack of all signal indications at a signalized location. (The dark mode is most commonly associated with power failures, ramp meters, hybrid beacons, beacons, and some movable bridge signals.)
48. **Delineator**—a retroreflective device mounted on the roadway surface or at the side of the roadway in a series to indicate the alignment of the roadway, especially at night or in adverse weather.
49. **Design Vehicle**—the longest vehicle permitted by statute of the road authority (State or other) on that roadway.
50. **Designated Bicycle Route**—a system of bikeways designated by the jurisdiction having authority with appropriate directional and informational route signs, with or without specific bicycle route numbers.
51. **Detectable**—having a continuous edge within 6 inches of the surface so that pedestrians who have visual disabilities can sense its presence and receive usable guidance information.
52. **Detector**—a device used for determining the presence or passage of vehicles or pedestrians.
53. **Downstream**—a term that refers to a location that is encountered by traffic subsequent to an upstream location as it flows in an "upstream to downstream" direction. For example, "the downstream end of a lane line separating the turn lane from a through lane on the approach to an intersection" is the end of the lane line that is closest to the intersection.
54. **Dropped Lane**—a through lane that becomes a mandatory turn lane on a conventional roadway, or a through lane that becomes a mandatory exit lane on a freeway or expressway. The end of an acceleration lane and reductions in the number of through lanes that do not involve a mandatory turn or exit are not considered dropped lanes.
55. **Dual-Arrow Signal Section**—a type of signal section designed to include both a yellow arrow and a green arrow.
56. **Dynamic Envelope**—the clearance required for light rail transit traffic or a train and its cargo overhang due to any combination of loading, lateral motion, or suspension failure (see Figure 8B-8 in the MUTCD).
57. **Dynamic Exit Gate Operating Mode**—a mode of operation where the exit gate operation is based on the presence of vehicles within the minimum track clearance distance.
58. **Edge Line Markings**—white or yellow pavement marking lines that delineate the right or left edge(s) of a traveled way.

59. **Electronic Toll Collection (ETC)**—a system for automated collection of tolls from moving or stopped vehicles through wireless technologies such as radio-frequency communication or optical scanning. ETC systems are classified as one of the following: (1) systems that require users to have registered toll accounts, with the use of equipment inside or on the exterior of vehicles, such as a transponder or barcode decal, that communicates with or is detected by roadside or overhead receiving equipment, or with the use of license plate optical scanning, to automatically deduct the toll from the registered user account, or (2) systems that do not require users to have registered toll accounts because vehicle license plates are optically scanned and invoices for the toll amount are sent through postal mail to the address of the vehicle owner.
60. **Electronic Toll Collection (ETC) Account Only Lane**—a non-attended toll lane that is restricted to use only by vehicles with a registered toll payment account.
61. **Emergency-Vehicle Hybrid Beacon**—a special type of hybrid beacon used to warn and control traffic at an unsignalized location to assist authorized emergency vehicles in entering or crossing a street or highway.
62. **Emergency-Vehicle Traffic Control Signal**—a special traffic control signal that assigns the right-of-way to an authorized emergency vehicle.
63. **End-of-Roadway Marker**—a device used to warn and alert road users of the end of a roadway in other than temporary traffic control zones.
64. **Engineering Judgment**—the evaluation of available pertinent information, and the application of appropriate principles, provisions, and practices as contained in this Manual and other sources, for the purpose of deciding upon the applicability, design, operation, or installation of a traffic control device. Engineering judgment shall be exercised by an engineer, or by an individual working under the supervision of an engineer, through the application of procedures and criteria established by the engineer. Documentation of engineering judgment is not required.
65. **Engineering Study**—the comprehensive analysis and evaluation of available pertinent information, and the application of appropriate principles, provisions, and practices as contained in this Manual and other sources, for the purpose of deciding upon the applicability, design, operation, or installation of a traffic control device. An engineering study shall be performed by an engineer, or by an individual working under the supervision of an engineer, through the application of procedures and criteria established by the engineer. An engineering study shall be documented.
66. **Entrance Gate**—an automatic gate that can be lowered across the lanes approaching a grade crossing to block road users from entering the grade crossing.
67. **Exact Change Lane (Automatic Lane)**—a non-attended toll lane that has a receptacle into which road users deposit coins totaling the exact amount of the toll. Exact Change lanes at toll plazas typically require vehicles to stop to pay the toll.

68. **Exit Gate**—an automatic gate that can be lowered across the lanes departing a grade crossing to block road users from entering the grade crossing by driving in the opposing traffic lanes.
69. **Exit Gate Clearance Time**—for Four-Quadrant Gate systems at grade crossings, the amount of time provided to delay the descent of the exit gate arm(s) after entrance gate arm(s) begin to descend.
70. **Exit Gate Operating Mode**—for Four-Quadrant Gate systems at grade crossings, the mode of control used to govern the operation of the exit gate arms.
71. **Expressway**—a divided highway with partial control of access.
72. **Flagger**—a person who actively controls the flow of vehicular traffic into and/or through a temporary traffic control zone using hand-signaling devices or an Automated Flagger Assistance Device (AFAD).
73. **Flasher**—a device used to turn highway traffic signal indications on and off at a repetitive rate of approximately once per second.
74. **Flashing**—an operation in which a light source, such as a traffic signal indication, is turned on and off repetitively.
75. **Flashing-Light Signals**—a warning device consisting of two red signal indications arranged horizontally that are activated to flash alternately when rail traffic is approaching or present at a grade crossing.
76. **Flashing Mode**—a mode of operation in which at least one traffic signal indication in each vehicular signal face of a highway traffic signal is turned on and off repetitively.
77. **Freeway**—a divided highway with full control of access.
78. **Full-Actuated Operation**—a type of traffic control signal operation in which all signal phases function on the basis of actuation.
79. **Gate**—an automatically-operated or manually-operated traffic control device that is used to physically obstruct road users such that they are discouraged from proceeding past a particular point on a roadway or pathway, or such that they are discouraged from entering a particular grade crossing, ramp, lane, roadway, or facility.
80. **Grade Crossing**—the general area where a highway and a railroad and/or light rail transit route cross at the same level, within which are included the tracks, highway, and traffic control devices for traffic traversing that area.
81. **Guide Sign**—a sign that shows route designations, destinations, directions, distances, services, points of interest, or other geographical, recreational, or cultural information.
82. **High-Occupancy Vehicle (HOV)**—a motor vehicle carrying at least two or more persons, including carpools, vanpools, and buses.
83. **Highway**—a general term for denoting a public way for purposes of vehicular travel, including the entire area within the right-of-way.
84. **Highway-Light Rail Transit Grade Crossing**—the general area where a highway and a light rail transit route cross at the same level, within which are included

the light rail transit tracks, highway, and traffic control devices for traffic traversing that area.

85. **Highway-Rail Grade Crossing**—the general area where a highway and a railroad cross at the same level, within which are included the railroad tracks, highway, and traffic control devices for highway traffic traversing that area.
86. **Highway Traffic Signal**—a power-operated traffic control device by which traffic is warned or directed to take some specific action. These devices do not include power-operated signs, steadily-illuminated pavement markers, warning lights (see [Section 6F.91 in the “Virginia Work Area Protection Manual”](#)), or steady burning electric lamps.
87. **HOV Lane**—any preferential lane designated for exclusive use by high-occupancy vehicles for all or part of a day—including a designated lane on a freeway, other highway, street, or independent roadway on a separate right-of-way.
88. **Hybrid Beacon**—a special type of beacon that is intentionally placed in a dark mode (no indications displayed) between periods of operation and, when operated, displays both steady and flashing traffic control signal indications.
89. **Inherently Low Emission Vehicle (ILEV)**—any kind of vehicle that, because of inherent properties of the fuel system design, will not have significant evaporative emissions, even if its evaporative emission control system has failed.
90. **In-Roadway Lights**—a special type of highway traffic signal installed in the roadway surface to warn road users that they are approaching a condition on or adjacent to the roadway that might not be readily apparent and might require the road users to slow down and/or come to a stop.
91. **Interchange**—a system of interconnecting roadways providing for traffic movement between two or more highways that do not intersect at grade.
92. **Interconnection**—when used in Part 8, the electrical connection between the railroad or light rail transit active warning system and the highway traffic signal controller assembly for the purpose of preemption.
93. **Intermediate Interchange**—an interchange with an urban or rural route that is not a major or minor interchange as defined in this Section.
94. **Intersection**—intersection is defined as follows:
  - a. The area embraced within the prolongation or connection of the lateral curb lines, or if none, the lateral boundary lines of the roadways of two highways that join one another at, or approximately at, right angles, or the area within which vehicles traveling on different highways that join at any other angle might come into conflict.
  - b. The junction of an alley or driveway with a roadway or highway shall not constitute an intersection, unless the roadway or highway at said junction is controlled by a traffic control device.
  - c. If a highway includes two roadways that are 30 feet or more apart (see definition of Median), then every crossing of each roadway of such divided highway by an intersecting highway shall be a separate intersection.

- d. **If both intersecting highways include two roadways that are 30 feet or more apart, then every crossing of any two roadways of such highways shall be a separate intersection.**
  - e. **At a location controlled by a traffic control signal, regardless of the distance between the separate intersections as defined in (c) and (d) above:**
    - 1. **If a stop line, yield line, or crosswalk has not been designated on the roadway (within the median) between the separate intersections, the two intersections and the roadway (median) between them shall be considered as one intersection;**
    - 2. **Where a stop line, yield line, or crosswalk is designated on the roadway on the intersection approach, the area within the crosswalk and/or beyond the designated stop line or yield line shall be part of the intersection; and**
    - 3. **Where a crosswalk is designated on a roadway on the departure from the intersection, the intersection shall include the area extending to the far side of such crosswalk.**
95. **Intersection Control Beacon**—a beacon used only at an intersection to control two or more directions of travel.
96. **Interval**—the part of a signal cycle during which signal indications do not change.
97. **Interval Sequence**—the order of appearance of signal indications during successive intervals of a signal cycle.
98. **Island**—a defined area between traffic lanes for control of vehicular movements, for toll collection, or for pedestrian refuge. It includes all end protection and approach treatments. Within an intersection area, a median or an outer separation is considered to be an island.
99. **Lane Drop**—see **Dropped Lane**.
100. **Lane Line Markings**—white pavement marking lines that delineate the separation of traffic lanes that have the same direction of travel on a roadway.
101. **Lane-Use Control Signal**—a signal face displaying indications to permit or prohibit the use of specific lanes of a roadway or to indicate the impending prohibition of such use.
102. **Legend**—see **Sign Legend**.
103. **Lens**—see **Signal Lens**.
104. **Light Rail Transit Traffic (Light Rail Transit Equipment)**—every device in, upon, or by which any person or property can be transported on light rail transit tracks, including single-unit light rail transit cars (such as streetcars and trolleys) and assemblies of multiple light rail transit cars coupled together.
105. **Locomotive Horn**—an air horn, steam whistle, or similar audible warning device (see 49 CFR Part 229.129) mounted on a locomotive or control cab car. The terms "locomotive horn," "train whistle," "locomotive whistle," and "train horn" are used interchangeably in the railroad industry.

- 106. Logo**—a distinctive emblem or trademark that identifies a commercial business and/or the product or service offered by the business.
- 107. Longitudinal Markings**—pavement markings that are generally placed parallel and adjacent to the flow of traffic such as lane lines, center lines, edge lines, channelizing lines, and others.
- 108. Louver**—see Signal Louver.
- 109. Major Interchange**—an interchange with another freeway or expressway, or an interchange with a high-volume multi-lane highway, principal urban arterial, or major rural route where the interchanging traffic is heavy or includes many road users unfamiliar with the area.
- 110. Major Street**—the street normally carrying the higher volume of vehicular traffic.
- 111. Malfunction Management Unit**—same as Conflict Monitor.
- 112. Managed Lane**—a highway lane or set of lanes, or a highway facility, for which variable operational strategies such as direction of travel, tolling, pricing, and/or vehicle type or occupancy requirements are implemented and managed in real-time in response to changing conditions. Managed lanes are typically buffer- or barrier-separated lanes parallel to the general-purpose lanes of a highway in which access is restricted to designated locations. There are also some highways on which all lanes are managed.
- 113. Manual Lane**—see Attended Lane.
- 114. Maximum Highway Traffic Signal Preemption Time**—the maximum amount of time needed following initiation of the preemption sequence for the highway traffic signals to complete the timing of the right-of-way transfer time, queue clearance time, and separation time.
- 115. Median**—the area between two roadways of a divided highway measured from edge of traveled way to edge of traveled way. The median excludes turn lanes. The median width might be different between intersections, interchanges, and at opposite approaches of the same intersection.
- 116. Minimum Track Clearance Distance**—for standard two-quadrant warning devices, the minimum track clearance distance is the length along a highway at one or more railroad or light rail transit tracks, measured from the highway stop line, warning device, or 12 feet perpendicular to the track center line, to 6 feet beyond the track(s) measured perpendicular to the far rail, along the center line or edge line of the highway, as appropriate, to obtain the longer distance. For Four-Quadrant Gate systems, the minimum track clearance distance is the length along a highway at one or more railroad or light rail transit tracks, measured either from the highway stop line or entrance warning device, to the point where the rear of the vehicle would be clear of the exit gate arm. In cases where the exit gate arm is parallel to the track(s) and is not perpendicular to the highway, the distance is measured either along the center line or edge line of the highway, as appropriate, to obtain the longer distance.

117. **Minimum Warning Time**—when used in Part 8, the least amount of time active warning devices shall operate prior to the arrival of rail traffic at a grade crossing.
118. **Minor Interchange**—an interchange where traffic is local and very light, such as interchanges with land service access roads. Where the sum of the exit volumes is estimated to be lower than 100 vehicles per day in the design year, the interchange is classified as local.
119. **Minor Street**—the street normally carrying the lower volume of vehicular traffic.
120. **Movable Bridge Resistance Gate**—a type of traffic gate, which is located downstream of the movable bridge warning gate, that provides a physical deterrent to vehicle and/or pedestrian traffic when placed in the appropriate position.
121. **Movable Bridge Signal**—a highway traffic signal installed at a movable bridge to notify traffic to stop during periods when the roadway is closed to allow the bridge to open.
122. **Movable Bridge Warning Gate**—a type of traffic gate designed to warn, but not primarily to block, vehicle and/or pedestrian traffic when placed in the appropriate position.
123. **Multi-Lane**—more than one lane moving in the same direction. A multi-lane street, highway, or roadway has a basic cross-section comprised of two or more through lanes in one or both directions. A multi-lane approach has two or more lanes moving toward the intersection, including turning lanes.
124. **Neutral Area**—the paved area between the channelizing lines separating an entrance or exit ramp or a channelized turn lane or channelized entering lane from the adjacent through lane(s).
125. **Object Marker**—a device used to mark obstructions within or adjacent to the roadway.
126. **Occupancy Requirement**—any restriction that regulates the use of a facility or one or more lanes of a facility for any period of the day based on a specified number of persons in a vehicle.
127. **Occupant**—a person driving or riding in a car, truck, bus, or other vehicle.
128. **Open-Road ETC Lane**—a non-attended lane that is designed to allow toll payments to be electronically collected from vehicles traveling at normal highway speeds. Open-Road ETC lanes are typically physically separated from the toll plaza, often following the alignment of the mainline lanes, with toll plaza lanes for cash toll payments being on a different alignment after diverging from the mainline lanes or a subset thereof.
129. **Open-Road Tolling**—a system designed to allow electronic toll collection (ETC) from vehicles traveling at normal highway speeds. Open-Road Tolling might be used on toll roads or toll facilities in conjunction with toll plazas. Open-Road Tolling is also typically used on managed lanes and on toll facilities that only accept payment by ETC.

130. **Open-Road Tolling Point**—the location along an Open-Road ETC lane at which roadside or overhead detection and receiving equipment are placed and vehicles are electronically assessed a toll.
131. **Opposing Traffic**—vehicles that are traveling in the opposite direction. At an intersection, vehicles entering from an approach that is approximately straight ahead would be considered to be opposing traffic, but vehicles entering from approaches on the left or right would not be considered to be opposing traffic.
132. **Overhead Sign**—a sign that is placed such that a portion or the entirety of the sign or its support is directly above the roadway or shoulder such that vehicles travel below it. Typical installations include signs placed on cantilever arms that extend over the roadway or shoulder, on sign support structures that span the entire width of the pavement, on mast arms or span wires that also support traffic control signals, and on highway bridges that cross over the roadway.
133. **Parking Area**—a parking lot or parking garage that is separated from a roadway. Parallel or angle parking spaces along a roadway are not considered a parking area.
134. **Passive Grade Crossing**—a grade crossing where none of the automatic traffic control devices associated with an Active Grade Crossing Warning System are present and at which the traffic control devices consist entirely of signs and/or markings.
135. **Pathway**—a general term denoting a public way for purposes of travel by authorized users outside the traveled way and physically separated from the roadway by an open space or barrier and either within the highway right-of-way or within an independent alignment. Pathways include shared-use paths, but do not include sidewalks.
136. **Pathway Grade Crossing**—the general area where a pathway and railroad or light rail transit tracks cross at the same level, within which are included the tracks, pathway, and traffic control devices for pathway traffic traversing that area.
137. **Paved**—a bituminous surface treatment, mixed bituminous concrete, or Portland cement concrete roadway surface that has both a structural (weight bearing) and a sealing purpose for the roadway.
138. **Pedestrian**—a person on foot, in a wheelchair, on skates, or on a skateboard.
139. **Pedestrian Change Interval**—an interval during which the flashing UPRAISED HAND (symbolizing DONT WALK) signal indication is displayed.
140. **Pedestrian Clearance Time**—the time provided for a pedestrian crossing in a crosswalk, after leaving the curb or shoulder, to travel to the far side of the traveled way or to a median.
141. **Pedestrian Facilities**—a general term denoting improvements and provisions made to accommodate or encourage walking.
142. **Pedestrian Hybrid Beacon**— a special type of hybrid beacon used to warn and control traffic at an unsignalized location to assist pedestrians in crossing a street or highway at a marked crosswalk.



143. **Pedestrian Signal Head**—a signal head, which contains the symbols WALKING PERSON (symbolizing WALK) and UPRAISED HAND (symbolizing DONT WALK), that is installed to direct pedestrian traffic at a traffic control signal.
144. **Permissive Mode**—a mode of traffic control signal operation in which left or right turns are permitted to be made after yielding to pedestrians, if any, and/or opposing traffic, if any. When a CIRCULAR GREEN signal indication is displayed, both left and right turns are permitted unless otherwise prohibited by another traffic control device. When a flashing YELLOW ARROW or flashing RED ARROW signal indication is displayed, the turn indicated by the arrow is permitted.
145. **Physical Gore**—a longitudinal point where a physical barrier or the lack of a paved surface inhibits road users from crossing from a ramp or channelized turn lane or channelized entering lane to the adjacent through lane(s) or vice versa.
146. **Pictograph**—a pictorial representation used to identify a governmental jurisdiction, an area of jurisdiction, a governmental agency, a military base or branch of service, a governmental-approved university or college, a toll payment system, or a government-approved institution.
147. **Plaque**—a traffic control device intended to communicate specific information to road users through a word, symbol, or arrow legend that is placed immediately adjacent to a sign to supplement the message on the sign. The difference between a plaque and a sign is that a plaque cannot be used alone. The designation for a plaque includes a "P" suffix.
148. **Platoon**—a group of vehicles or pedestrians traveling together as a group, either voluntarily or involuntarily, because of traffic signal controls, geometrics, or other factors.
149. **Portable Traffic Control Signal**—a temporary traffic control signal that is designed so that it can be easily transported and reused at different locations.
150. **Post-Mounted Sign**—a sign that is placed to the side of the roadway such that no portion of the sign or its support is directly above the roadway or shoulder.
151. **Posted Speed Limit**—a speed limit determined by law or regulation and displayed on Speed Limit signs.
152. **Preemption**—the transfer of normal operation of a traffic control signal to a special control mode of operation.
153. **Preferential Lane**—a highway lane reserved for the exclusive use of one or more specific types of vehicles or vehicles with at least a specific number of occupants.
154. **Pre-signal**—traffic control signal faces that control traffic approaching a grade crossing in conjunction with the traffic control signal faces that control traffic approaching a highway-highway intersection beyond the tracks. Supplemental near-side traffic control signal faces for the highway-highway intersection are not considered pre-signals. Pre-signals are typically used where the clear storage distance is insufficient to store one or more design vehicles.
155. **Pretimed Operation**—a type of traffic control signal operation in which none of the signal phases function on the basis of actuation.

156. **Primary Signal Face**—one of the required or recommended minimum number of signal faces for a given approach or separate turning movement, but not including near-side signal faces required as a result of the far-side signal faces exceeding the maximum distance from the stop line.
157. **Principal Legend**—place names, street names, and route numbers placed on guide signs.
158. **Priority Control**—a means by which the assignment of right-of-way is obtained or modified.
159. **Private Road Open to Public Travel**—private toll roads and roads (including any adjacent sidewalks that generally run parallel to the road) within shopping centers, airports, sports arenas, and other similar business and/or recreation facilities that are privately owned, but where the public is allowed to travel without access restrictions. Roads within private gated properties (except for gated toll roads) where access is restricted at all times, parking areas, driving aisles within parking areas, and private grade crossings shall not be included in this definition.
160. **Protected Mode**—a mode of traffic control signal operation in which left or right turns are permitted to be made when a left or right GREEN ARROW signal indication is displayed.
161. **Public Road**—any road, street, or similar facility under the jurisdiction of and maintained by a public agency and open to public travel.
162. **Pushbutton**—a button to activate a device or signal timing for pedestrians, bicyclists, or other road users.
163. **Pushbutton Information Message**—a recorded message that can be actuated by pressing a pushbutton when the walk interval is not timing and that provides the name of the street that the crosswalk associated with that particular pushbutton crosses and can also provide other information about the intersection signalization or geometry.
164. **Pushbutton Locator Tone**—a repeating sound that informs approaching pedestrians that a pushbutton exists to actuate pedestrian timing or receive additional information and that enables pedestrians who have visual disabilities to locate the pushbutton.
165. **Queue Clearance Time**—when used in Part 8, the time required for the design vehicle of maximum length stopped just inside the minimum track clearance distance to start up and move through and clear the entire minimum track clearance distance. If pre-signals are present, this time shall be long enough to allow the vehicle to move through the intersection, or to clear the tracks if there is sufficient clear storage distance. If a Four-Quadrant Gate system is present, this time shall be long enough to permit the exit gate arm to lower after the design vehicle is clear of the minimum track clearance distance.
166. **Quiet Zone**—a segment of a rail line, with one or a number of consecutive public highway-rail grade crossings at which locomotive horns are not routinely sounded per 49 CFR Part 222.

- 167. Rail Traffic—every device in, upon, or by which any person or property can be transported on rails or tracks and to which all other traffic must yield the right-of-way by law at grade crossings, including trains, one or more locomotives coupled (with or without cars), other railroad equipment, and light rail transit operating in exclusive or semi-exclusive alignments. Light rail transit operating in a mixed-use alignment, to which other traffic is not required to yield the right-of-way by law, is a vehicle and is not considered to be rail traffic.**
- 168. Raised Pavement Marker—a device mounted on or in a road surface that has a height generally not exceeding approximately 1 inch above the road surface for a permanent marker, or not exceeding approximately 2 inches above the road surface for a temporary flexible marker, and that is intended to be used as a positioning guide and/or to supplement or substitute for pavement markings.**
- 169. Ramp Control Signal—a highway traffic signal installed to control the flow of traffic onto a freeway at an entrance ramp or at a freeway-to-freeway ramp connection.**
- 170. Ramp Meter—see Ramp Control Signal.**
- 171. Red Clearance Interval—an interval that follows a yellow change interval and precedes the next conflicting green interval.**
- 172. Regulatory Sign—a sign that gives notice to road users of traffic laws or regulations.**
- 173. Retroreflectivity—a property of a surface that allows a large portion of the light coming from a point source to be returned directly back to a point near its origin.**
- 174. Right-of-Way [Assignment]—the permitting of vehicles and/or pedestrians to proceed in a lawful manner in preference to other vehicles or pedestrians by the display of a sign or signal indications.**
- 175. Right-of-Way Transfer Time—when used in Part 8, the maximum amount of time needed for the worst case condition, prior to display of the track clearance green interval. This includes any railroad or light rail transit or highway traffic signal control equipment time to react to a preemption call, and any traffic control signal green, pedestrian walk and clearance, yellow change, and red clearance intervals for conflicting traffic.**
- 176. Road—see Roadway.**
- 177. Road User—a vehicle operator, bicyclist, or pedestrian, including persons with disabilities, within the highway or on a private road open to public travel.**
- 178. Roadway—that portion of a highway improved, designed, or ordinarily used for vehicular travel and parking lanes, but exclusive of the sidewalk, berm, or shoulder even though such sidewalk, berm, or shoulder is used by persons riding bicycles or other human-powered vehicles. In the event a highway includes two or more separate roadways, the term roadway as used in this Manual shall refer to any such roadway separately, but not to all such roadways collectively.**
- 179. Roadway Network—a geographical arrangement of intersecting roadways.**

- 180. Roundabout**—a circular intersection with yield control at entry, which permits a vehicle on the circulatory roadway to proceed, and with deflection of the approaching vehicle counter-clockwise around a central island.
- 181. Rumble Strip**—a series of intermittent, narrow, transverse areas of rough-textured, slightly raised, or depressed road surface that extend across the travel lane to alert road users to unusual traffic conditions or are located along the shoulder, along the roadway center line, or within islands formed by pavement markings to alert road users that they are leaving the travel lanes.
- 182. Rural Highway**—a type of roadway normally characterized by lower volumes, higher speeds, fewer turning conflicts, and less conflict with pedestrians.
- 183. Safe-Positioned**—the positioning of emergency vehicles at an incident in a manner that attempts to protect both the responders performing their duties and road users traveling through the incident scene, while minimizing, to the extent practical, disruption of the adjacent traffic flow.
- 184. School**—a public or private educational institution recognized by the state education authority for one or more grades K through 12 or as otherwise defined by the State.
- 185. School Zone**—a designated roadway segment approaching, adjacent to, and beyond school buildings or grounds, or along which school related activities occur.
- 186. Semi-Actuated Operation**—a type of traffic control signal operation in which at least one, but not all, signal phases function on the basis of actuation.
- 187. Separate Turn Signal Face**—a signal face that exclusively controls a turn movement and that displays signal indications that are applicable only to the turn movement.
- 188. Separation Time**—the component of maximum highway traffic signal preemption time during which the minimum track clearance distance is clear of vehicular traffic prior to the arrival of rail traffic.
- 189. Shared Roadway**—a roadway that is officially designated and marked as a bicycle route, but which is open to motor vehicle travel and upon which no bicycle lane is designated.
- 190. Shared Turn Signal Face**—a signal face, for controlling both a turn movement and the adjacent through movement, that always displays the same color of circular signal indication that the adjacent through signal face or faces display.
- 191. Shared-Use Path**—a bikeway outside the traveled way and physically separated from motorized vehicular traffic by an open space or barrier and either within the highway right-of-way or within an independent alignment. Shared-use paths are also used by pedestrians (including skaters, users of manual and motorized wheelchairs, and joggers) and other authorized motorized and non-motorized users.
- 192. Sidewalk**—that portion of a street between the curb line, or the lateral line of a roadway, and the adjacent property line or on easements of private property that is paved or improved and intended for use by pedestrians.

193. **Sign**—any traffic control device that is intended to communicate specific information to road users through a word, symbol, and/or arrow legend. Signs do not include highway traffic signals, pavement markings, delineators, or channelization devices.
194. **Sign Assembly**—a group of signs, located on the same support(s), that supplement one another in conveying information to road users.
195. **Sign Illumination**—either internal or external lighting that shows similar color by day or night. Street or highway lighting shall not be considered as meeting this definition.
196. **Sign Legend**—all word messages, logos, pictographs, and symbol and arrow designs that are intended to convey specific meanings. The border, if any, on a sign is not considered to be a part of the legend.
197. **Sign Panel**—a separate panel or piece of material containing a word, symbol, and/or arrow legend that is affixed to the face of a sign.
198. **Signal Backplate**—a thin strip of material that extends outward from and parallel to a signal face on all sides of a signal housing to provide a background for improved visibility of the signal indications.
199. **Signal Coordination**—the establishment of timed relationships between adjacent traffic control signals.
200. **Signal Face**—an assembly of one or more signal sections that is provided for controlling one or more traffic movements on a single approach.
201. **Signal Head**—an assembly of one or more signal faces that is provided for controlling traffic movements on one or more approaches.
202. **Signal Housing**—that part of a signal section that protects the light source and other required components.
203. **Signal Indication**—the illumination of a signal lens or equivalent device.
204. **Signal Lens**—that part of the signal section that redirects the light coming directly from the light source and its reflector, if any.
205. **Signal Louver**—a device that can be mounted inside a signal visor to restrict visibility of a signal indication from the side or to limit the visibility of the signal indication to a certain lane or lanes, or to a certain distance from the stop line.
206. **Signal Phase**—the right-of-way, yellow change, and red clearance intervals in a cycle that are assigned to an independent traffic movement or combination of movements.
207. **Signal Section**—the assembly of a signal housing, signal lens, if any, and light source with necessary components to be used for displaying one signal indication.
208. **Signal System**—two or more traffic control signals operating in signal coordination.
209. **Signal Timing**—the amount of time allocated for the display of a signal indication.

210. **Signal Visor**—that part of a signal section that directs the signal indication specifically to approaching traffic and reduces the effect of direct external light entering the signal lens.
211. **Signing**—individual signs or a group of signs, not necessarily on the same support(s), that supplement one another in conveying information to road users.
212. **Simultaneous Preemption**—notification of approaching rail traffic is forwarded to the highway traffic signal controller unit or assembly and railroad or light rail transit active warning devices at the same time.
213. **Special Purpose Road**—a low-volume, low-speed road that serves recreational areas or resource development activities.
214. **Speed**—speed is defined based on the following classifications:
  - a. **Average Speed**—the summation of the instantaneous or spot-measured speeds at a specific location of vehicles divided by the number of vehicles observed.
  - b. **Design Speed**—a selected speed used to determine the various geometric design features of a roadway.
  - c. **85th-Percentile Speed**—the speed at or below which 85 percent of the motor vehicles travel.
  - d. **Operating Speed**—a speed at which a typical vehicle or the overall traffic operates. Operating speed might be defined with speed values such as the average, pace, or 85th-percentile speeds.
  - e. **Pace**—the 10 mph speed range representing the speeds of the largest percentage of vehicles in the traffic stream.
215. **Speed Limit**—the maximum (or minimum) speed applicable to a section of highway as established by law or regulation.
216. **Speed Limit Sign Beacon**—a beacon used to supplement a SPEED LIMIT sign.
217. **Speed Measurement Markings**—a white transverse pavement marking placed on the roadway to assist the enforcement of speed regulations.
218. **Speed Zone**—a section of highway with a speed limit that is established by law or regulation, but which might be different from a legislatively specified statutory speed limit.
219. **Splitter Island**—a median island used to separate opposing directions of traffic entering and exiting a roundabout.
220. **Station Crossing**—a pathway grade crossing that is associated with a station platform.
221. **Statutory Speed Limit**—a speed limit established by legislative action that typically is applicable for a particular class of highways with specified design, functional, jurisdictional and/or location characteristics and that is not necessarily displayed on Speed Limit signs.
222. **Steady (Steady Mode)**—the continuous display of a signal indication for the duration of an interval, signal phase, or consecutive signal phases.

- 223. Stop Beacon**—a beacon used to supplement a STOP sign, a DO NOT ENTER sign, or a WRONG WAY sign.
- 224. Stop Line**—a solid white pavement marking line extending across approach lanes to indicate the point at which a stop is intended or required to be made.
- 225. Street**—see Highway.
- 226. Supplemental Signal Face**—a signal face that is not a primary signal face but which is provided for a given approach or separate turning movement to enhance visibility or conspicuity.
- 227. Symbol**—the approved design of a pictorial representation of a specific traffic control message for signs, pavement markings, traffic control signals, or other traffic control devices, as shown in the MUTCD.
- 228. Temporary Traffic Control Signal**—a traffic control signal that is installed for a limited time period.
- 229. Temporary Traffic Control Zone**—an area of a highway where road user conditions are changed because of a work zone or incident by the use of temporary traffic control devices, flaggers, uniformed law enforcement officers, or other authorized personnel.
- 230. Theoretical Gore**—a longitudinal point at the upstream end of a neutral area at an exit ramp or channelized turn lane where the channelizing lines that separate the ramp or channelized turn lane from the adjacent through lane(s) begin to diverge, or a longitudinal point at the downstream end of a neutral area at an entrance ramp or channelized entering lane where the channelizing lines that separate the ramp or channelized entering lane from the adjacent through lane(s) intersect each other.
- 231. Timed Exit Gate Operating Mode**—a mode of operation where the exit gate descent at a grade crossing is based on a predetermined time interval.
- 232. Toll Booth**—a shelter where a toll attendant is stationed to collect tolls or issue toll tickets. A toll booth is located adjacent to a toll lane and is typically set on a toll island.
- 233. Toll Island**—a raised island on which a toll booth or other toll collection and related equipment are located.
- 234. Toll Lane**—an individual lane located within a toll plaza in which a toll payment is collected or, for toll-ticket systems, a toll ticket is issued.
- 235. Toll Plaza**—the location at which tolls are collected consisting of a grouping of toll booths, toll islands, toll lanes, and, typically, a canopy. Toll plazas might be located on highway mainlines or on interchange ramps. A mainline toll plaza is sometimes referred to as a barrier toll plaza because it interrupts the traffic flow.
- 236. Toll-Ticket System**—a system in which the user of a toll road receives a ticket from a machine or toll booth attendant upon entering a toll system. The ticket denotes the user's point of entry and, upon exiting the toll system, the user surrenders the ticket and is charged a toll based on the distance traveled between the points of entry and exit.

237. **Traffic**—pedestrians, bicyclists, ridden or herded animals, vehicles, streetcars, and other conveyances either singularly or together while using for purposes of travel any highway or private road open to public travel.
238. **Traffic Control Device**—a sign, signal, marking, or other device used to regulate, warn, or guide traffic, placed on, over, or adjacent to a street, highway, private road open to public travel, pedestrian facility, or shared-use path by authority of a public agency or official having jurisdiction, or, in the case of a private road open to public travel, by authority of the private owner or private official having jurisdiction.
239. **Traffic Control Signal (Traffic Signal)**—any highway traffic signal by which traffic is alternately directed to stop and permitted to proceed.
240. **Train**—one or more locomotives coupled, with or without cars, that operates on rails or tracks and to which all other traffic must yield the right-of-way by law at highway-rail grade crossings.
241. **Transverse Markings**—pavement markings that are generally placed perpendicular and across the flow of traffic such as shoulder markings; word, symbol, and arrow markings; stop lines; crosswalk lines; speed measurement markings; parking space markings; and others.
242. **Traveled Way**—the portion of the roadway for the movement of vehicles, exclusive of the shoulders, berms, sidewalks, and parking lanes.
243. **Turn Bay**—a lane for the exclusive use of turning vehicles that is formed on the approach to the location where the turn is to be made. In most cases where turn bays are provided, drivers who desire to turn must move out of a through lane into the newly formed turn bay in order to turn. A through lane that becomes a turn lane is considered to be a dropped lane rather than a turn bay.
244. **Upstream**—a term that refers to a location that is encountered by traffic prior to a downstream location as it flows in an "upstream to downstream" direction. For example, "the upstream end of a lane line separating the turn lane from a through lane on the approach to an intersection" is the end of the line that is furthest from the intersection.
245. **Urban Street**—a type of street normally characterized by relatively low speeds, wide ranges of traffic volumes, narrower lanes, frequent intersections and driveways, significant pedestrian traffic, and more businesses and houses.
246. **Vehicle**—every device in, upon, or by which any person or property can be transported or drawn upon a highway, except trains and light rail transit operating in exclusive or semi-exclusive alignments. Light rail transit equipment operating in a mixed-use alignment, to which other traffic is not required to yield the right-of-way by law, is a vehicle.
247. **Vibrotactile Pedestrian Device**—an accessible pedestrian signal feature that communicates, by touch, information about pedestrian timing using a vibrating surface.
248. **Visibility-Limited Signal Face or Visibility-Limited Signal Section**—a type of signal face or signal section designed (or shielded, hooded, or louvered) to restrict the



visibility of a signal indication from the side, to a certain lane or lanes, or to a certain distance from the stop line.

249. **Walk Interval**—an interval during which the WALKING PERSON (symbolizing WALK) signal indication is displayed.
250. **Warning Beacon**—a beacon used only to supplement an appropriate warning or regulatory sign or marker.
251. **Warning Light**—a portable, powered, yellow, lens-directed, enclosed light that is used in a temporary traffic control zone in either a steady burn or a flashing mode.
252. **Warning Sign**—a sign that gives notice to road users of a situation that might not be readily apparent.
253. **Warrant**—a warrant describes a threshold condition based upon average or normal conditions that, if found to be satisfied as part of an engineering study, shall result in analysis of other traffic conditions or factors to determine whether a traffic control device or other improvement is justified. Warrants are not a substitute for engineering judgment. The fact that a warrant for a particular traffic control device is met is not conclusive justification for the installation of the device.
254. **Wayside Equipment**—the signals, switches, and/or control devices for railroad or light rail transit operations housed within one or more enclosures located along the railroad or light rail transit right-of-way and/or on railroad or light rail transit property.
255. **Wayside Horn System**—a stationary horn (or series of horns) located at a grade crossing that is used in conjunction with train-activated or light rail transit-activated warning systems to provide audible warning of approaching rail traffic to road users on the highway or pathway approaches to a grade crossing, either as a supplement or alternative to the sounding of a locomotive horn.
256. **Worker**—a person on foot whose duties place him or her within the right-of-way of a street, highway, or pathway, such as street, highway, or pathway construction and maintenance forces, survey crews, utility crews, responders to incidents within the street, highway, or pathway right-of-way, and law enforcement personnel when directing traffic, investigating crashes, and handling lane closures, obstructed roadways, and disasters within the right-of-way of a street, highway, or pathway.
257. **Wrong-Way Arrow**—a slender, elongated, white pavement marking arrow placed upstream from the ramp terminus to indicate the correct direction of traffic flow. Wrong-way arrows are intended primarily to warn wrong-way road users that they are going in the wrong direction.
258. **Yellow Change Interval**—the first interval following the green or flashing arrow interval during which the steady yellow signal indication is displayed.
259. **Yield Line**—a row of solid white isosceles triangles pointing toward approaching vehicles extending across approach lanes to indicate the point at which the yield is intended or required to be made.

**Standard:**

- 05 The following words and phrases, when used in this Supplement, shall have the following meanings:

1. **Limited Access Highway** — The legal definition of a limited access highway as found in the Code of Virginia (a link to the code is provided in Appendix A) is:\* a highway especially designed for through traffic, over which abutters have no easement or right of light, air, or access to by reason of the fact that their property abuts upon such highway. This includes freeways, expressways and other partially-controlled access facilities.

~~2. **Wayside** — a State maintained area adjacent to the roadway which may provide parking and picnic areas.\*~~

2. **Primary Route** – a road that connect cities and towns with each other and with interstates. Primary Routes include all US Routes, Virginia State Routes numbered 599 and below, and Virginia State Route 895 in Chesterfield and Henrico Counties.

3. **Secondary Route** – local connector or county roads maintained by VDOT, numbered 600 and above. Arlington and Henrico Counties do not contain VDOT-maintained secondary routes, as these jurisdictions maintain their own county roads.

(The following item was formerly item 2 and has been relocated. The text, as written, is not new.)\*

4. **Wayside** — a State maintained area adjacent to the roadway which may provide parking and picnic areas.\*

**Support:**

- 06 The definition of Limited Access Highway can be found in The Code of Virginia § 33.1-57.

## **Section 1A.14 Meanings of Acronyms and Abbreviations in this Manual**

**Standard:**

- 01 The following acronyms and abbreviations, when used in the MUTCD and this Supplement, shall have the following meanings:

1. **AADT**—annual average daily traffic
2. **AASHTO**—American Association of State Highway and Transportation Officials
3. **ADA**—Americans with Disabilities Act
4. **ADAAG**—Americans with Disabilities Accessibility Guidelines
5. **ADT**—average daily traffic
6. **AFAD**—Automated Flagger Assistance Device
7. **ANSI**—American National Standards Institute
8. **CFR**—Code of Federal Regulations


9. **CMS—changeable message sign**
10. **dBa—A-weighted decibels**
11. **EPA—Environmental Protection Agency**
12. **ETC—electronic toll collection**
13. **EV—electric vehicle**
14. **FHWA—Federal Highway Administration**
15. **FRA—Federal Railroad Administration**
16. **FTA—Federal Transit Administration**
17. **HOT—high occupancy tolls**
18. **HOTM—FHWA's Office of Transportation Management**
19. **HOTO—FHWA's Office of Transportation Operations**
20. **HOV—high-occupancy vehicle**
21. **ILEV—inherently low emission vehicle**
22. **ISEA—International Safety Equipment Association**
23. **ITE—Institute of Transportation Engineers**
24. **ITS—intelligent transportation systems**
25. **LED—light emitting diode**
26. **LP—liquid petroleum**
27. **MPH or mph—miles per hour**
28. **MUTCD—Manual on Uniform Traffic Control Devices**
29. **NCHRP—National Cooperative Highway Research Program**
30. **ORT—open-road tolling**
31. **PCMS—portable changeable message sign**
32. **PRT—perception-response time**
33. **RPM—raised pavement marker**
34. **RRPM—raised retroreflective pavement marker**
35. **RV—recreational vehicle**
36. **TDD—telecommunication devices for the deaf**
37. **TRB—Transportation Research Board**
38. **TTC—temporary traffic control**
39. **U.S.—United States**
40. **U.S.C.—United States Code**
41. **USDOT—United States Department of Transportation**
42. **UVC—Uniform Vehicle Code**
43. **VPH or vph—vehicles per hour**



- Standard:**
- 02 **In addition to the acronyms and abbreviations originally presented in this Section of the 2009 MUTCD, the following acronyms and abbreviations, when used in this Supplement, shall have the following meanings:**
- 1. VDOT – Virginia Department of Transportation**
  - 2. TED – VDOT Traffic Engineering Division**
  - 3. CTB – Commonwealth Transportation Board**
  - 4. VA – Virginia**

## **PART 2. SIGNS**

<b>CHAPTER 2A. GENERAL</b>	<b>PAGE</b>
Section 2A.01 Function and Purpose of Signs	
Section 2A.02 Definitions	
Section 2A.03 Standardization of Application	
Section 2A.04 Excessive Use of Signs	
Section 2A.05 Classification of Signs	
Section 2A.06 Design of Signs .....	2-1
Section 2A.07 Retroreflectivity and Illumination	
Section 2A.08 Maintaining Minimum Retroreflectivity	
Section 2A.09 Shapes	
Section 2A.10 Sign Colors .....	2-3
Section 2A.11 Dimensions .....	2-5
Section 2A.12 Symbols	
Section 2A.13 Word Messages .....	2-6
Section 2A.14 Sign Borders	
Section 2A.15 Enhanced Conspicuity for Standard Signs	
Section 2A.16 Standardization of Location	
Section 2A.17 Overhead Sign Installations	
Section 2A.18 Mounting Height .....	2-8
Section 2A.19 Lateral Offset	
Section 2A.20 Orientation	
Section 2A.21 Posts and Mountings	
Section 2A.22 Maintenance	
Section 2A.23 Median Opening Treatments for Divided Highways with Wide Medians	
<b>CHAPTER 2B. REGULATORY SIGNS, BARRICADES, AND GATES</b>	<b>PAGE</b>
Section 2B.01 Application of Regulatory Signs	
Section 2B.02 Design of Regulatory Signs	
Section 2B.03 Size of Regulatory Signs	
Section 2B.04 Right-of-Way at Intersections	
Section 2B.05 STOP Sign (R1-1) and ALL WAY Plaque (R1-3P)	
Section 2B.06 STOP Sign Applications	
Section 2B.07 Multi-Way Stop Applications	
Section 2B.08 YIELD Sign (R1-2)	
Section 2B.09 YIELD Sign Applications .....	2-12

	Section 2B.10	STOP Sign or YIELD Sign Placement	
	Section 2B.11	Yield Here To Pedestrians Signs and Stop Here For Pedestrians Signs (R1-5 Series).....	2-20
	Section 2B.12	In-Street and Overhead Pedestrian Crossing Signs (R1-6, R1-6a, R1-9, and R1-9a) .....	2-22
	Section 2B.13	Speed Limit and End XX Mile Speed Signs (R2-1, R2-V2) .....	2-23
	Section 2B.14	Truck Speed Limit Plaque (R2-2P)	
	Section 2B.15	Night Speed Limit Plaque (R2-3P)	
	Section 2B.16	Minimum Speed Limit Plaque (R2-4P)	
	Section 2B.17	Higher Fines Signs and Plaque (R2-6P, R2-10, and R2-11)	
	Section 2B.18	Movement Prohibition Signs (R3-1 through R3-4, R3-18, and R3-27)	
	Section 2B.19	Intersection Lane Control Signs (R3-5 through R3-8)	
	Section 2B.20	Mandatory Movement Lane Control Signs (R3-5, R3-5a, R3-7, and R3-20)	
	Section 2B.21	Optional Movement Lane Control Sign (R3-6, R3-V1) .....	2-27
	Section 2B.22	Advance Intersection Lane Control Signs (R3-8 Series)	
	Section 2B.23	RIGHT (LEFT) LANE MUST EXIT Sign (R3-33)	
	Section 2B.24	Two-Way Left Turn Only Signs (R3-9a, R3-9b)	
	Section 2B.25	BEGIN and END Plaques (R3-9cP, R3-9cP (V), R3-9dP) .....	2-29
	Section 2B.26	Reversible Lane Control Signs (R3-9e through R3-9i)	
	Section 2B.27	Jughandle Signs (R3-23, R3-24, R3-25, and R3-26 Series)	
	Section 2B.28	DO NOT PASS Sign (R4-1)	
	Section 2B.29	PASS WITH CARE Sign (R4-2)	
	Section 2B.30	KEEP RIGHT EXCEPT TO PASS Sign (R4-16) and SLOWER TRAFFIC KEEP RIGHT Sign (R4-3)	
	Section 2B.31	TRUCKS USE RIGHT LANE Sign (R4-5)	
	Section 2B.32	Keep Right and Keep Left Signs (R4-7, R4-8)	
	Section 2B.33	STAY IN LANE Sign (R4-9)	
	Section 2B.34	RUNAWAY VEHICLES ONLY Sign (R4-10)	
	Section 2B.35	Slow Vehicle Turn-Out Signs (R4-12, R4-13, and R4-14)	
	Section 2B.36	DO NOT DRIVE ON SHOULDER Sign (R4-17) and DO NOT PASS ON SHOULDER Sign (R4-18)	
	Section 2B.37	DO NOT ENTER Sign (R5-1)	
	Section 2B.38	WRONG WAY Sign (R5-1a)	
	Section 2B.39	Selective Exclusion Signs .....	2-30
	Section 2B.40	ONE WAY Signs (R6-1, R6-2)	
	Section 2B.41	Wrong-Way Traffic Control at Interchange Ramps.....	2-32
	Section 2B.42	Divided Highway Crossing Signs (R6-3, R6-3a)	
	Section 2B.43	Roundabout Directional Arrow Signs (R6-4, R6-4a, and R6-4b)	

	Section 2B.44	Roundabout Circulation Plaque (R6-5P)	
	Section 2B.45	Examples of Roundabout Signing	
	Section 2B.46	Parking, Standing, and Stopping Signs (R7 and R8 Series) .....	2-35
	Section 2B.47	Design of Parking, Standing, and Stopping Signs	
	Section 2B.48	Placement of Parking, Stopping, and Standing Signs	
	Section 2B.49	Emergency Restriction Signs (R8-4, R8-7, R8-8, <a href="#">R8-VP1</a> ) .....	2-39
	Section 2B.50	WALK ON LEFT FACING TRAFFIC and No Hitchhiking Signs (R9-1, R9-4, R9-4a) .....	2-40
	Section 2B.51	Pedestrian Crossing Signs (R9-2, R9-3)	
	Section 2B.52	Traffic Signal Pedestrian and Bicycle Actuation Signs (R10-1 through R10-4, and R10-24 through R10-26)	
	Section 2B.53	Traffic Signal Signs (R10-5 through R10-30).....	2-40
	Section 2B.54	No Turn on Red Signs (R10-11 Series, R10-17a, and R10-30)	
	Section 2B.55	Photo Enforced Signs and Plaques (R10-18, R10-19P, R10-19aP, <a href="#">R10-18a</a> ) .	2-45
	Section 2B.56	Ramp Metering Signs (R10-28 and R10-29)	
	Section 2B.57	KEEP OFF MEDIAN Sign (R11-1)	
	Section 2B.58	ROAD CLOSED Sign (R11-2) and LOCAL TRAFFIC ONLY Signs (R11-3 Series, R11-4)	
	Section 2B.59	Weight Limit Signs (R12-1 through <a href="#">R12-4</a> , <a href="#">R12-5</a> , <a href="#">R12-V1</a> , <a href="#">R12-VP1</a> ) .....	2-46
	Section 2B.60	Weigh Station Signs (R13 Series)	
	Section 2B.61	TRUCK ROUTE Sign (R14-1)	
	Section 2B.62	Hazardous Material Signs (R14-2, R14-3)	
	Section 2B.63	National Network Signs (R14-4, R14-5)	
	Section 2B.64	Headlight Use Signs (R16-5 through R16-11).....	2-50
	Section 2B.65	FENDER BENDER Sign (R16-4, <a href="#">R16-4 (V)</a> ) .....	2-51
	Section 2B.66	Seat Belt Symbol Section	
	Section 2B.67	Barricades	
	Section 2B.68	Gates	
	Section 2B.V1	<a href="#">Anti Littering Signs (R0-V1, R0-V2)</a> .....	2-52
	Section 2B.V2	<a href="#">Radar and Speed Limit Enforcement Signs (R0-V3, R0-V4)</a> .....	2-52
	Section 2B.V3	<a href="#">Highway Safety Corridor Signs (R0-V5, R0-V6, R0-9cP (V))</a> .....	2-54
	Section 2B.V4	<a href="#">Rest Area Directional Sign (R0-V8)</a> .....	2-55
	Section 2B.V5	<a href="#">TOWED VEHICLES Plaque (R2-VP1)</a> .....	2-56
	Section 2B.V6	<a href="#">NO FISHING FROM BRIDGE Signs (R9-V1)</a> .....	2-56
	Section 2B.V7	<a href="#">Commercial Vehicle Lane Restriction Signs (R4-V Series)</a> .....	2-57
	Section 2B.V8	<a href="#">Pedestrian Swing Bridge Sign (R9-V2)</a> .....	2-58

<b>CHAPTER 2C.</b>	<b>WARNING SIGNS AND OBJECT MARKERS</b>	<b>PAGE</b>
Section 2C.01	Function of Warning Signs	
Section 2C.02	Application of Warning Signs .....	2-60
Section 2C.03	Design of Warning Signs	
Section 2C.04	Size of Warning Signs	
Section 2C.05	Placement of Warning Signs	
Section 2C.06	Horizontal Alignment Warning Signs .....	2-67
Section 2C.07	Horizontal Alignment Signs (W1-1 through W1-5, W1-11, W1-15)	
Section 2C.08	Advisory Speed Plaque (W13-1P).....	2-69
Section 2C.09	Chevron Alignment Sign (W1-8)	
Section 2C.10	Combination Horizontal Alignment/Advisory Speed Signs (W1-1a, W1-2a)	
Section 2C.11	Combination Horizontal Alignment/Intersection Signs (W1-10 Series)	
Section 2C.12	One-Direction Large Arrow Sign (W1-6)	
Section 2C.13	Truck Rollover Warning Sign (W1-13, <a href="#">W1-13 (V)</a> ).....	2-70
Section 2C.14	Advisory Exit and Ramp Speed Signs (W13-2 and W13-3)	
Section 2C.15	Combination Horizontal Alignment/Advisory Exit and Ramp Speed Signs (W13-6 and W13-7)	
Section 2C.16	Hill Signs (W7-1, W7-1a)	
Section 2C.17	Truck Escape Ramp Signs (W7-4 Series)	
Section 2C.18	HILL BLOCKS VIEW Sign (W7-6)	
Section 2C.19	ROAD NARROWS Sign (W5-1)	
Section 2C.20	NARROW BRIDGE Sign (W5-2)	
Section 2C.21	ONE LANE BRIDGE Sign (W5-3) .....	2-71
Section 2C.22	Divided Highway Sign (W6-1)	
Section 2C.23	Divided Highway Ends Sign (W6-2)	
Section 2C.24	Freeway or Expressway Ends Signs (W19 Series)	
Section 2C.25	Double Arrow Sign (W12-1)	
Section 2C.26	DEAD END/NO OUTLET Signs (W14-1, W14-1a, W14-2, W14-2a)	
Section 2C.27	Low Clearance Signs (W12-2 and W12-2a) .....	2-73
Section 2C.28	BUMP and DIP Signs (W8-1, W8-2) .....	2-76
Section 2C.29	SPEED HUMP Sign (W17-1)	
Section 2C.30	PAVEMENT ENDS Sign (W8-3)	
Section 2C.31	Shoulder Signs (W8-4, W8-9, W8-17, W8-23, and W8-25)	
Section 2C.32	Surface Condition Signs (W8-5, W8-7, W8-8, W8-11, W8-13, and W8-14)	
Section 2C.33	Warning Signs and Plaques for Motorcyclists (W8-15, W8-15P, <del>and W8-16</del> , <a href="#">W8-V1</a> , <a href="#">W8-V2</a> , and <a href="#">W8-V3</a> ) .....	2-77
Section 2C.34	NO CENTER LINE Sign (W8-12)	





Section 2C.35 Weather Condition Signs (W8-18, W8-19, W8-21, and W8-22)

Section 2C.36 Advance Traffic Control Signs (W3-1, W3-2, W3-3, W3-4)

Section 2C.37 Advance Ramp Control Signal Signs (W3-7 and W3-8)

Section 2C.38 Reduced Speed Limit Ahead Signs (W3-5, W3-5a) ..... 2-80

Section 2C.39 DRAW BRIDGE Sign (W3-6)

Section 2C.40 Merge Signs (W4-1, W4-5)

Section 2C.41 Added Lane Signs (W4-3, W4-6)

Section 2C.42 Lane Ends Signs (W4-2, W9-1, W9-2)

Section 2C.43 RIGHT (LEFT) LANE EXIT ONLY AHEAD Sign (W9-7)

Section 2C.44 Two-Way Traffic Sign (W6-3)

Section 2C.45 NO PASSING ZONE Sign (W14-3)

Section 2C.46 Intersection Warning Signs (W2-1 through W2-8)

Section 2C.47 Two-Direction Large Arrow Sign (W1-7)

Section 2C.48 Traffic Signal Signs (W25-1, W25-2)

Section 2C.49 Vehicular Traffic Warning Signs (W8-6, W11-1, W11-5, W11-5a, W11-8, W11-10, W11-11, W11-12P, W11-14, W11-15, and W11-15a, [W11-V1](#), [W11-V3](#))..... 2-82

Section 2C.50 Non-Vehicular Warning Signs (W11-2, W11-3, W11-4, W11-6, W11-7, W11-9, and W11-16 through W11-22)..... 2-85

Section 2C.51 Playground Sign (W15-1)..... 2-88

Section 2C.52 NEW TRAFFIC PATTERN AHEAD Sign (W23-2)

Section 2C.53 Use of Supplemental Warning Plaques

Section 2C.54 Design of Supplemental Warning Plaques

Section 2C.55 Distance Plaques (W16-2 Series, W16-3 Series, W16-4P, W7-3aP)

Section 2C.56 Supplemental Arrow Plaques (W16-5P, W16-6P)

Section 2C.57 Hill-Related Plaques (W7-2 Series, W7-3 Series)

Section 2C.58 Advance Street Name Plaque (W16-8P, W16-8aP)

Section 2C.59 CROSS TRAFFIC DOES NOT STOP Plaque (W4-4P)

Section 2C.60 SHARE THE ROAD Plaque (W16-1P)

Section 2C.61 Photo Enforced Plaque (W16-10P)

Section 2C.62 NEW Plaque (W16-15P)

Section 2C.63 Object Marker Design and Placement Height..... 2-88

Section 2C.64 Object Markers for Obstructions Within the Roadway

Section 2C.65 Object Markers for Obstructions Adjacent to the Roadway

Section 2C.66 Object Markers for Ends of Roadways

[Section 2C.V1 Watch for Children \(W15-V1\)..... 2-89](#)

[Section 2C.V2 STEEP GRADE AHEAD Plaque ..... 2-91](#)

<b>CHAPTER 2D</b>	<b>GUIDE SIGNS—CONVENTIONAL ROADS</b>	<b>PAGE</b>
Section 2D.01	Scope of Conventional Road Guide Sign Standards	
Section 2D.02	Application	
Section 2D.03	Color, Retroreflection, and Illumination	
Section 2D.04	Size of Signs .....	2-92
Section 2D.05	Lettering Style .....	2-95
Section 2D.06	Size of Lettering	
Section 2D.07	Amount of Legend	
Section 2D.08	Arrows	
Section 2D.09	Numbered Highway Systems .....	2-96
Section 2D.10	Route Signs and Auxiliary Signs	
Section 2D.11	Design of Route Signs .....	2-96
Section 2D.12	Design of Route Sign Auxiliaries .....	2-99
Section 2D.13	Junction Auxiliary Sign (M2-1)	
Section 2D.14	Combination Junction Sign (M2-2)	
Section 2D.15	Cardinal Direction Auxiliary Signs (M3-1 through M3-4)	
Section 2D.16	Auxiliary Signs for Alternative Routes (M4 Series)	
Section 2D.17	ALTERNATE Auxiliary Signs (M4-1, M4-1a)	
Section 2D.18	BY-PASS Auxiliary Sign (M4-2)	
Section 2D.19	BUSINESS Auxiliary Sign (M4-3)	
Section 2D.20	TRUCK Auxiliary Sign (M4-4)	
Section 2D.21	TO Auxiliary Sign (M4-5)	
Section 2D.22	END Auxiliary Sign (M4-6)	
Section 2D.23	BEGIN Auxiliary Sign (M4-14)	
Section 2D.24	TEMPORARY Auxiliary Signs (M4-7, M4-7a)	
Section 2D.25	Temporary Detour and Auxiliary Signs	
Section 2D.26	Advance Turn Arrow Auxiliary Signs (M5-1, M5-2, and M5-3)	
Section 2D.27	Lane Designation Auxiliary Signs (M5-4, M5-5, and M5-6)	
Section 2D.28	Directional Arrow Auxiliary Signs (M6 Series)	
Section 2D.29	Route Sign Assemblies .....	2-99
Section 2D.30	Junction Assembly	
Section 2D.31	Advance Route Turn Assembly	
Section 2D.32	Directional Assembly	
Section 2D.33	Combination Lane-Use/Destination Overhead Guide Sign (D15-1)	
Section 2D.34	Confirming or Reassurance Assemblies	
Section 2D.35	Trailblazer Assembly	
Section 2D.36	Destination and Distance Signs	



Section 2D.37	Destination Signs (D1 Series)	
Section 2D.38	Destination Signs at Circular Intersections	
Section 2D.39	Destination Signs at Jughandles	
Section 2D.40	Location of Destination Signs	
Section 2D.41	Distance Signs (D2 Series)	
Section 2D.42	Location of Distance Signs .....	2-105
Section 2D.43	Street Name Signs (D3-1, D3-1a, D3-V1, D3-V1a, D3-V1b, or D3-V3).....	2-105
Section 2D.44	Advance Street Name Signs (D3-2 & D3-V2).....	2-110
Section 2D.45	Signing on Conventional Roads on Approaches to Interchanges	
Section 2D.46	Freeway Entrance Signs (D13-3 and D13-3a)	
Section 2D.47	Parking Area Guide Sign (D4-1)	
Section 2D.48	PARK - RIDE Sign (D4-2)	
Section 2D.49	Weigh Station Signing (D8 Series)	
Section 2D.50	Community Wayfinding Signs	
Section 2D.51	Truck, Passing, or Climbing Lane Signs (D17-1 and D17-2)	
Section 2D.52	Slow Vehicle Turn-Out Sign (D17-7)	
Section 2D.53	Signing of Named Highways .....	2-112
Section 2D.54	Crossover Signs (D13-1 and D13-2)	
Section 2D.55	National Scenic Byways Signs (D6-4, D6-4a)	
Section 2D.V1	OLD Auxiliary Signs .....	2-113
Section 2D.V2	VIRGINIA BYWAY (D6-V1) Signs.....	2-113



<b>CHAPTER 2E</b>	<b>GUIDE SIGNS—FREEWAYS AND EXPRESSWAYS</b>	<b>PAGE</b>
Section 2E.01	Scope of Freeway and Expressway Guide Sign Standards	
Section 2E.02	Freeway and Expressway Signing Principles	
Section 2E.03	Guide Sign Classification	
Section 2E.04	General	
Section 2E.05	Color of Guide Signs	
Section 2E.06	Retroreflection or Illumination	
Section 2E.07	Characteristics of Urban Signing	
Section 2E.08	Characteristics of Rural Signing	
Section 2E.09	Signing of Named Highways	
Section 2E.10	Amount of Legend on Guide Signs	
Section 2E.11	Number of Signs at an Overhead Installation and Sign Spreading	
Section 2E.12	Pull-Through Signs (E6-2, E6-2a)	
Section 2E.13	Designation of Destinations	
Section 2E.14	Size and Style of Letters and Signs .....	2-115

Section 2E.15	Interline and Edge Spacing	
Section 2E.16	Sign Borders	
Section 2E.17	Abbreviations	
Section 2E.18	Symbols	
Section 2E.19	Arrows for Interchange Guide Signs	
Section 2E.20	Signing for Option Lanes at Splits and Multi-Lane Exits	
Section 2E.21	Design of Overhead Arrow-per-Lane Guide Signs for Option Lanes	
Section 2E.22	Design of Freeway and Expressway Diagrammatic Guide Signs for Option Lanes	
Section 2E.23	Signing for Intermediate and Minor Interchange Multi-Lane Exits with an Option Lane	
Section 2E.24	Signing for Interchange Lane Drops	
Section 2E.25	Overhead Sign Installations	
Section 2E.26	Lateral Offset	
Section 2E.27	Route Signs and Trailblazer Assemblies .....	2-124
Section 2E.28	Eisenhower Interstate System Signs (M1-10, M1-10a)	
Section 2E.29	Signs for Intersections at Grade	
Section 2E.30	Interchange Guide Signs	
Section 2E.31	Interchange Exit Numbering	
Section 2E.32	Interchange Classification	
Section 2E.33	Advance Guide Signs	
Section 2E.34	Next Exit Plaques	
Section 2E.35	Other Supplemental Guide Signs	
Section 2E.36	Exit Direction Signs	
Section 2E.37	Exit Gore Signs (E5-1 Series)	
Section 2E.38	Post-Interchange Signs	
Section 2E.39	Post-Interchange Distance Signs	
Section 2E.40	Interchange Sequence Signs	
Section 2E.41	Community Interchanges Identification Signs	
Section 2E.42	NEXT XX EXITS Sign	
Section 2E.43	Signing by Type of Interchange	
Section 2E.44	Freeway-to-Freeway Interchange	
Section 2E.45	Cloverleaf Interchange	
Section 2E.46	Cloverleaf Interchange with Collector-Distributor Roadways	
Section 2E.47	Partial Cloverleaf Interchange	
Section 2E.48	Diamond Interchange	
Section 2E.49	Diamond Interchange in Urban Area	
Section 2E.50	Closely-Spaced Interchanges	
Section 2E.51	Minor Interchange	

- Section 2E.52 Signing on Conventional Road Approaches and Connecting Roadways
- Section 2E.53 Wrong-Way Traffic Control at Interchange Ramps
- Section 2E.54 Weigh Station Signing

**CHAPTER 2F: TOLL ROAD SIGNS** **PAGE**

Section 2F.01	Scope	
Section 2F.02	Sizes of Toll Road Signs	
Section 2F.03	Use of Purple Backgrounds and Underlay Panels with ETC Account Pictographs	
Section 2F.04	Size of ETC Pictographs	
Section 2F.05	Regulatory Signs for Toll Plazas	
Section 2F.06	Pay Toll Advance Warning Sign (W9-6)	
Section 2F.07	Pay Toll Advance Warning Plaque (W9-6P)	
Section 2F.08	Stop Ahead Pay Toll Warning Sign (W9-6a)	
Section 2F.09	Stop Ahead Pay Toll Warning Plaque (W9-6aP)	
Section 2F.10	LAST EXIT BEFORE TOLL Warning Plaque (W16-16P)	
Section 2F.11	TOLL Auxiliary Sign (M4-15)	
Section 2F.12	Electronic Toll Collection (ETC) Account-Only Auxiliary Signs (M4-16 and M4-20)	2-127
Section 2F.13	Toll Facility and Toll Plaza Guide Signs – General	
Section 2F.14	Advance Signs for Conventional Toll Plazas	
Section 2F.15	Advance Signs for Toll Plazas on Diverging Alignments from Open-Road ETC Account-Only Lanes	
Section 2F.16	Toll Plaza Canopy Signs	
Section 2F.17	Guide Signs for Entrances to ETC Account-Only Facilities	
Section 2F.18	ETC Program Information Signs	
Section 2F.V1	Toll Payment Regulatory Signs	2-128



**CHAPTER 2H GENERAL INFORMATION SIGNS** **PAGE**

Section 2H.01	Sizes of General Information Signs	
Section 2H.02	General Information Signs (I Series)	2-129
Section 2H.03	Traffic Signal Speed Sign (I1-1)	
Section 2H.04	Miscellaneous Information Signs	2-131
Section 2H.05	Reference Location Signs (D10-1 through D10-3) and Intermediate Reference Location Signs (D10-1a through D10-3a)	2-134
Section 2H.06	Enhanced Reference Location Signs (D10-4, D10-5)	
Section 2H.07	Auto Tour Route Signs	
Section 2H.08	Acknowledgment Signs	2-139



[Section 2H.V1 Crossroad Identification \(D10-V1\) Signs ..... 2-142](#)

**CHAPTER 2I GENERAL SERVICE SIGNS PAGE**

Section 2I.01 Sizes of General Service Signs  
 Section 2I.02 General Service Signs for Conventional Roads  
 Section 2I.03 General Service Signs for Freeways and Expressways  
 Section 2I.04 Interstate Oasis Signing  
 Section 2I.05 Rest Area and Other Roadside Area Signs ..... 2-144  
 Section 2I.06 Brake Check Area Signs (D5-13 and D5-14)  
 Section 2I.07 Chain-Up Area Signs (D5-15 and D5-16)  
 Section 2I.08 Tourist Information and Welcome Center Signs  
 Section 2I.09 Radio Information Signing ..... 2-149  
 Section 2I.10 TRAVEL INFO CALL 511 Signs (D12-5 and D12-5a)  
 Section 2I.11 Carpool and Ridesharing Signing

**CHAPTER 2M RECREATIONAL AND CULTURAL INTEREST AREA SIGNS PAGE**

Section 2M.01 Scope  
 Section 2M.02 Application of Recreational and Cultural Interest Area Signs  
 Section 2M.03 Regulatory and Warning Signs  
 Section 2M.04 General Design Requirements for Recreational and Cultural Interest Area Symbol  
 Section 2M.05 Symbol Sign Sizes  
 Section 2M.06 Use of Educational Plaques  
 Section 2M.07 Use of Prohibitive Circle and Diagonal Slash for Non-Road Applications  
 Section 2M.08 Placement of Recreational and Cultural Interest Area Symbol Signs ..... 2-152  
 Section 2M.09 Destination Guide Signs  
 Section 2M.10 Memorial or Dedication Signing ..... 2-163  
[Section 2M.V1 Advance Signing for Historical Markers \(I-V11 signs\) ..... 2-165](#)  
[Section 2M.V2 Signing for Waysides \(I-V13 and I-V14 signs\) ..... 2-166](#)




# PART 2

## SIGNS

### CHAPTER 2A. GENERAL

#### Section 2A.06 Design of Signs

Support:

- 01 This Manual shows many typical standard signs and object markers approved for use on streets, highways, bikeways, and pedestrian crossings.
- 02 In the specifications for individual signs and object markers, the general appearance of the legend, color, and size are shown in the accompanying tables and illustrations, and are not always detailed in the text.
- 03 Detailed drawings of standard signs, object markers, alphabets, symbols, and arrows (see [Figure 2D-2 in the MUTCD](#)) are shown in the "Standard Highway Signs and Markings" book. [Section 1A.11 of this Supplement](#) contains information regarding how to obtain this publication.
- 04  In addition, detailed drawings of standard signs used in Virginia are shown in the "Virginia Standard Highway Signs Book". [Appendix A of this Supplement](#) contains a link to this Virginia publication.
- 05 The basic requirements of a sign are that it be legible to those for whom it is intended and that it be understandable in time to permit a proper response. Desirable attributes include:
  - A. High visibility by day and night; and
  - B. High legibility (adequately sized letters, symbols, or arrows, and a short legend for quick comprehension by a road user approaching a sign).
- 06 Standardized colors and shapes are specified so that the several classes of traffic signs can be promptly recognized. Simplicity and uniformity in design, position, and application are important.

**Standard:**

- 07 **The term legend shall include all word messages and symbol and arrow designs that are intended to convey specific meanings.**
- 08 **Uniformity in design shall include shape, color, dimensions, legends, borders, and illumination or retroreflectivity.**
- 09 **Standardization of these designs does not preclude further improvement by minor changes in the proportion or orientation of symbols, width of borders, or layout of word messages, but all shapes and colors shall be as indicated.**

- 10 **All symbols shall be unmistakably similar to, or mirror images of, the adopted symbol signs, all of which are shown in the "Standard Highway Signs and Markings" and the "Virginia Standard Highway Signs" book (see Section 1A.11 of this Supplement and Appendix A of this Supplement). Symbols and colors shall not be modified unless otherwise provided in this Manual. All symbols and colors for signs not shown in the "Standard Highway Signs and Markings" and the "Virginia Standard Highway Signs" book shall follow the procedures for experimentation and change described in Section 1A.10 of this Supplement.**

Option:

- 11 Although the standard design of symbol signs cannot be modified, the orientation of the symbol may be changed to better reflect the direction of travel, if appropriate.

**Standard:**

- 12 **Where a standard word message is applicable, the wording shall be as provided in the MUTCD or this Supplement.**
- 13 **In situations where word messages are required other than those provided in the MUTCD or this Supplement, the signs shall be of the same shape and color as standard signs of the same functional type.**



- 14 **As indicated in Section 1A.10 of this Supplement, Paragraph 25, any proposed or modified permanent Regulatory or Warning signs not in the MUTCD or this Supplement shall be submitted for review and approval by VDOT's Office of the State Traffic Engineer. Signs shall not be fabricated or installed prior to approval. This requirement shall apply whether or not submission to FHWA is required.**

Option:

- 15 State and local highway agencies may develop special word message signs in situations where roadway conditions make it necessary to provide road users with additional regulatory, warning, or guidance information, such as when road users need to be notified of special regulations or warned about a situation that might not be readily apparent. Unlike colors that have not been assigned or symbols that have not been approved for signs, new word message signs may be used without the need for experimentation.

**Standard:**

- 16 **Except as provided in Paragraph 18 and except for the Carpool Information (D12-2) sign (see Section 21.11 of the MUTCD), Internet addresses and e-mail addresses, including domain names and uniform resource locators (URL), shall not be displayed on any sign, supplemental plaque, sign panel (including logo sign panels on Specific Service signs), or changeable message sign.**

*Guidance:*

- 17 *Unless otherwise provided in this Supplement or the MUTCD for a specific sign, and except as provided in Paragraph 18, telephone numbers of more than four characters should not be displayed on any sign, supplemental plaque, sign panel (including logo sign panels on specific service signs), or changeable message sign.*



**Option:**

- 18 Internet addresses, e-mail addresses, or telephone numbers with more than four characters may be displayed on signs, supplemental plaques, sign panels, and changeable message signs that are intended for viewing only by pedestrians, bicyclists, occupants of parked vehicles, or drivers of vehicles on low-speed roadways where engineering judgment indicates that an area is available for drivers to stop out of the traffic flow to read the message.

**Standard:**

- 19 **Pictographs (see definition in [Section 1A.13 of this Supplement](#)) shall not be displayed on signs except as specifically provided in this Supplement or in the MUTCD. Pictographs shall be simple, dignified, and devoid of any advertising. When used to represent a political jurisdiction (such as a State, county, or municipal corporation) the pictograph shall be the official designation adopted by the jurisdiction. When used to represent a college or university, the pictograph shall be the official seal adopted by the institution. Pictorial representations of university or college programs shall not be permitted to be displayed on a sign.**

## **Section 2A.10 Sign Colors**

**Standard:**

- 01 **The colors to be used on standard signs and their specific use on these signs shall be as provided in the applicable Sections of [the MUTCD or this Supplement](#). The color coordinates and values shall be as described in 23 CFR, Part 655, Subpart F, Appendix.**

**Support:**

- 02 As a quick reference, common uses of sign colors are shown in [Table 2A-5\(VA\) in this Supplement](#). Color schemes on specific signs are shown in the illustrations located in each appropriate Chapter of [the MUTCD and this Supplement](#).
- 03 Whenever white is specified as a color in this Supplement, the "Standard Highway Signs and Markings" book (see [Section 1A.11 of this Supplement](#)), or the "Virginia Standard Highway Signs" book (see [Appendix A of this Supplement for link](#)), it is understood to include silver-colored retroreflective coatings or elements that reflect white light.
- 04 The colors coral and light blue are being reserved for uses that will be determined in the future by the Federal Highway Administration.
- 05 Information regarding color coding of destinations on guide signs, including community wayfinding signs, is contained in Chapter 2D.

**Option:**

- 06 The approved fluorescent version of the standard red, yellow, green, or orange color may be used as an alternative to the corresponding standard color.

**Table 2A-5(VA). Common Uses of Sign Colors**

Type of Sign	Legend									Background											
	Black	Green	Red	White	Yellow	Orange	Fluorescent Yellow-Green	Fluorescent Pink		Black	Blue	Brown	Green	Orange*	Red*	White	Yellow*	Purple	Fluorescent Yellow-Green	Fluorescent Pink	
Regulatory	X		X	X						X					X	X					
Prohibitive			X	X											X	X					
Permissive		X														X					
Warning	X																X				
Pedestrian	X																			X	
Bicycle	X																			X	
Guide				X								X									
Interstate Route				X							X			X							
State Route	X															X					
U.S. Route	X															X					
County Route					X						X										
Forest Route				X								X									
Street Name				X									X								
Destination				X									X								
Reference Location				X									X								
Information				X							X		X								
Evacuation Route				X							X										
Road User Service				X							X										
Recreational				X								X	X								
Temporary Traffic Control	X													X							
Incident Management	X													X							X
School	X																			X	
ETC-Account Only	X																	X****			
Changeable Message Signs																					
Regulatory			X***	X						X											
Warning					X					X											
Temporary Traffic Control					X	X				X											
Guide				X						X			X**								
Motorist Services				X						X	X**										
Incident Management					X			X		X											
School, Pedestrian, Bicycle	X																			X	

\* Fluorescent versions of these background colors may also be used.

\*\* These alternative background colors would be provided by blue or green lighted pixels such that the entire CMS would be lighted, not just the legend.

\*\*\* Red is used only for the circle and slash or other red elements of a similar static regulatory sign.

\*\*\*\* The use of the color purple on signs is restricted per the provisions of Paragraph 1 of Section 2F.03 of the MUTCD.

## Section 2A.11 Dimensions

### Support:

- 01 The "Standard Highway Signs and Markings" and "Virginia Standard Highway Signs" book (see [Appendix A and Section 1A.11 of this Supplement](#)) prescribe design details for up to five different sizes depending on the type of traffic facility, including bikeways. Smaller sizes are designed to be used on bikeways and some other off-road applications. Larger sizes are designed for use on freeways and expressways, and can also be used to enhance road user safety and convenience on other facilities, especially on multi-lane divided highways and on undivided highways having five or more lanes of traffic and/or high speeds. The intermediate sizes are designed to be used on other highway types.

### Standard:

- 02 **The sign dimensions prescribed in the sign size tables in the various Parts and Chapters in the MUTCD, this Supplement, the "Standard Highway Signs and Markings," and the "Virginia Standard Highway Signs" book (see [Section 1A.11 and Appendix A of this Supplement](#)) shall be used unless engineering judgment determines that other sizes are appropriate. Except as provided in Paragraph 3, where engineering judgment determines that sizes smaller than the prescribed dimensions are appropriate for use, the sign dimensions shall not be less than the minimum dimensions specified in [the MUTCD or this Supplement](#). The sizes shown in the Minimum columns that are smaller than the sizes shown in the Conventional Road columns in the various sign size tables in [the MUTCD or this Supplement](#) shall only be used on low-speed roadways, alleys, and private roads open to public travel where the reduced legend size would be adequate for the regulation or warning or where physical conditions preclude the use of larger sizes.**

### Option:

- 03 For alleys with restrictive physical conditions and vehicle usage that limits installation of the minimum size sign (or the Conventional Road size sign if no Minimum size is shown), both the sign height and the sign width may be decreased by up to 6 inches.

### Guidance:

- 04 *The sizes shown in the Freeway and Expressway columns in the various sign size tables in [the MUTCD or this Supplement](#) should be used on freeways and expressways, and for other higher-speed applications based upon engineering judgment, to provide larger signs for increased visibility and recognition.*
- 05 *The sizes shown in the Oversized columns in the various sign size tables in [the MUTCD or this Supplement](#) size should be used for those special applications where speed, volume, or other factors result in conditions where increased emphasis, improved recognition, or increased legibility is needed, as determined by engineering judgment or study.*
- 06 *Increases above the prescribed sizes should be used where greater legibility or emphasis is needed. If signs larger than the prescribed sizes are used, the overall sign dimensions should be increased in 6-inch increments.*

**Standard:**

- 07 **Where engineering judgment determines that sizes that are different than the prescribed dimensions are appropriate for use, standard shapes and colors shall be used and standard proportions shall be retained as much as practical.**

*Guidance:*

- 08 *When supplemental plaques are installed with larger sized signs, a corresponding increase in the size of the plaque and its legend should also be made. The resulting plaque size should be approximately in the same relative proportion to the larger sized sign as the conventional sized plaque is to the conventional sized sign.*

## **Section 2A.13 Word Messages**

**Standard:**

- 01 **Except as provided in [Section 2A.06 of this Supplement](#), all word messages shall use standard wording and letters as shown in this Manual and in the "Standard Highway Signs and Markings" and the\* "[Virginia Standard Highway Signs](#)" book (see [Section 1A.11 and Appendix A of this Supplement](#)).**

*Guidance:*

- 02 *Word messages should be as brief as possible and the lettering should be large enough to provide the necessary legibility distance. A minimum specific ratio of 1 inch of letter height per 30 feet of legibility distance should be used.*
- 03 *Abbreviations (see [Section 1A.15 of the MUTCD](#)) should be kept to a minimum.*
- 04 *Word messages should not contain periods, apostrophes, question marks, ampersands, or other punctuation or characters that are not letters, numerals, or hyphens unless necessary to avoid confusion.*
- 05 *The solidus (slanted line or forward slash) is intended to be used for fractions only and should not be used to separate words on the same line of legend. Instead, a hyphen should be used for this purpose, such as "TRUCKS - BUSES."*

**Standard:**

- 06 **Fractions shall be displayed with the numerator and denominator diagonally arranged about the solidus (slanted line or forward slash). The overall height of the fraction is measured from the top of the numerator to the bottom of the denominator, each of which is vertically aligned with the upper and lower ends of the solidus. The overall height of the fraction shall be determined by the height of the numerals within the fraction, and shall be 1.5 times the height of an individual numeral within the fraction.**

*Support:*

- 07 The "Standard Highway Signs and Markings" book (see [Section 1A.11 of this Supplement](#)) contains details regarding the layouts of fractions on signs.

*Guidance:*

- 08 *When initials are used to represent an abbreviation for separate words (such as "U S" for a United States route), the initials should be separated by a space of between 1/2 and 3/4 of the letter height of the initials.*
- 09 *When an Interstate route is displayed in text form instead of using the route shield, a hyphen should be used for clarity, such as "I-50."*

**Standard:**

- 10 **All sign lettering shall be in upper-case letters as provided in the "Standard Highway Signs and Markings" and "Virginia Standard Highway Signs" book (see Section 1A.11 and Appendix A of this Supplement), unless otherwise provided in this Supplement or the MUTCD for a particular sign or type of message.**
- 11 **The sign lettering for names of places, streets, and highways shall be composed of a combination of lower-case letters with initial upper-case letters.**

*Support:*

- 12 Letter height is expressed in terms of the height of an upper-case letter. For mixed-case legends (those composed of an initial upper-case letter followed by lower-case letters), the height of the lower-case letters is derived from the specified height of the initial upper-case letter based on a prescribed ratio. Letter heights for mixed-case legends might be expressed in terms of both the upper- and lower-case letters, or in terms of the initial upper-case letter alone. When the height of a lower-case letter is specified or determined from the prescribed ratio, the reference is to the nominal loop height of the letter. The term loop height refers to the portion of a lower-case letter that excludes any ascending or descending stems or tails of the letter, such as with the letters "d" or "q." The nominal loop height is equal to the actual height of a non-rounded lower-case letter whose form does not include ascending or descending stems or tails, such as the letter "x." The rounded portions of a lower-case letter extend slightly above and below the baselines projected from the top and bottom of such a non-rounded letter so that the appearance of a uniform letter height within a word is achieved. The actual loop height of a rounded lower-case letter is slightly greater than the nominal loop height and this additional height is excluded from the expression of the lower-case letter height.

**Standard:**

- 13 **When In\* a mixed-case sign\* legend is used composed of letters from the Standard Highway Sign Alphabets\*, the height of the lower-case letters shall be 3/4 of the height of the initial upper-case letter.**
- 14 **The unique letter forms for each of the Standard Alphabet series shall not be stretched, compressed, warped, or otherwise manipulated.**

*Support:*

- 15 [Section 2D.04 of this Supplement](#) contains information regarding the acceptable methods of modifying the length of a word for a given letter height and series.





**Standard Option\*:**

- 16 In accordance with Interim Approval IA-5, dated September 2, 2004 - Interim Approval for Use of Clearview Font for Positive Contrast Legends on Guide Signs, positive contrast (e.g. white legend on a green, blue, or brown background\*) guide signs shall\* may be designed using Clearview font for the mixed-case portions of the sign legend. Section 2E.14 of this Supplement contains additional information related to the implementation and use of Clearview font\*.

**Standard:**

- 17 **Except as provided in Paragraph 18\*, all other signs sign legends\* shall be designed using the Federal Standard Highway Sign Alphabets provided in the "Standard Highway Signs and Markings" book.\***

**Option:**

- 18 In accordance with Section 2D.50 of the National MUTCD, a lettering style other than the Standard Highway Sign Alphabets may be used on community wayfinding signs if an engineering study determines that the legibility and recognition values for the chosen lettering style meet or exceed the values for the Standard Highway Sign Alphabets for the same legend height and stroke width.\*

**Support:**

- 1819 A Clearview spacing table and guide for converting the Federal Standard Highway Signs (SHS) Alphabet to the Clearview font is shown in the "Virginia Standard Highway Signs" book (see Appendix A of this Supplement for link).

## Section 2A.18 Mounting Height

**Standard:**

- 01 **The provisions of this Section shall apply unless specifically stated otherwise for a particular sign or object marker elsewhere in the MUTCD or this Supplement.**

**Support:**

- 02 The mounting height requirements for object markers are provided in Chapter 2C.
- 03 In addition to the provisions of this Section, information affecting the minimum mounting height of signs as a function of crash performance can be found in AASHTO's "Roadside Design Guide" (see Section 1A.11 of this Supplement).

**Standard:**

- 04 **The minimum height, measured vertically from the bottom of the sign to the elevation of the near edge of the pavement, of signs installed at the side of the road in rural areas shall be 5 feet (see Figure 2A-2(VA) in this Supplement).**
- 05 **The minimum height, measured vertically from the bottom of the sign to the top of the curb, or in the absence of curb, measured vertically from the bottom of the sign to the elevation of the near edge of the traveled way, of signs installed at the side of the road in business, commercial, or residential areas where parking or pedestrian movements are likely to occur, or where the view of the sign might be obstructed, shall be 7 feet (see Figure 2A-2(VA) in this Supplement).**

Option:

- 06 The height to the bottom of a secondary sign mounted below another sign may be 1 foot less than the height specified in Paragraphs 4 and 5.

**Standard:**

- 07 **The minimum height, measured vertically from the bottom of the sign to the sidewalk, of signs installed above sidewalks shall be 7 feet.**
- 08 **If the bottom of a secondary sign that is mounted below another sign is mounted lower than 7 feet above a pedestrian sidewalk or pathway (see [Section 6D.02 of the 2011 “Virginia Work Area Protection Manual”](#)), the secondary sign shall not project more than 4 inches into the pedestrian facility.**

Option:

- 09 Signs that are placed 30 feet or more from the edge of the traveled way may be installed with a minimum height of 5 feet, measured vertically from the bottom of the sign to the elevation of the near edge of the pavement.

**Standard:**

- 10 **Directional signs on freeways and expressways shall be installed with a minimum height of 7 feet, measured vertically from the bottom of the sign to the elevation of the near edge of the pavement. All route signs, warning signs, and regulatory signs on freeways and expressways shall be installed with a minimum height of 7 feet, measured vertically from the bottom of the sign to the elevation of the near edge of the pavement. If a secondary sign is mounted below another sign on a freeway or expressway, the major sign shall be installed with a minimum height of 8 feet and the secondary sign shall be installed with a minimum height of 5 feet, measured vertically from the bottom of the sign to the elevation of the near edge of the pavement.**
- 11 **Where large signs having an area exceeding 50 square feet are installed on multiple breakaway posts, the clearance from the ground to the bottom of the sign shall be at least 7 feet.**

Option:

- 12 A route sign assembly consisting of a route sign and auxiliary signs (see [Section 2D.31 of the MUTCD](#)) may be treated as a single sign for the purposes of this Section.
- 13 The mounting height may be adjusted when supports are located near the edge of the right-of-way on a steep backslope in order to avoid the sometimes less desirable alternative of placing the sign closer to the roadway.

*Guidance:*

- 14 *Vertical clearance for overhead sign structures should be no less than 19 feet and no more than 21 feet from the bottom of the lowest mounted sign panel to the crown of the roadway. Luminaire assemblies or other hardware mounted below the sign panel\* should have a vertical clearance of no less than 17 feet 6 inches from the bottom of the assembly hardware\* to the crown of the roadway.*



**Standard:**

- 15 **Overhead signs shall provide a vertical clearance of not less than 17 feet 6 inches to the sign, luminaire assembly, or sign bridge over the entire width of the pavement and shoulders except where the structure on which the overhead signs are to be mounted or other structures along the roadway near the sign structure have a lesser vertical clearance.**

**Option:**

- 16 If the vertical clearance of other structures along the roadway near the sign structure is less than 16 feet, the vertical clearance to an overhead sign structure or support may be as low as 1 foot higher than the vertical clearance of the other structures in order to improve the visibility of the overhead signs.
- 17 In special cases it may be necessary to reduce the clearance to overhead signs because of substandard dimensions in tunnels and other major structures such as double-deck bridges.

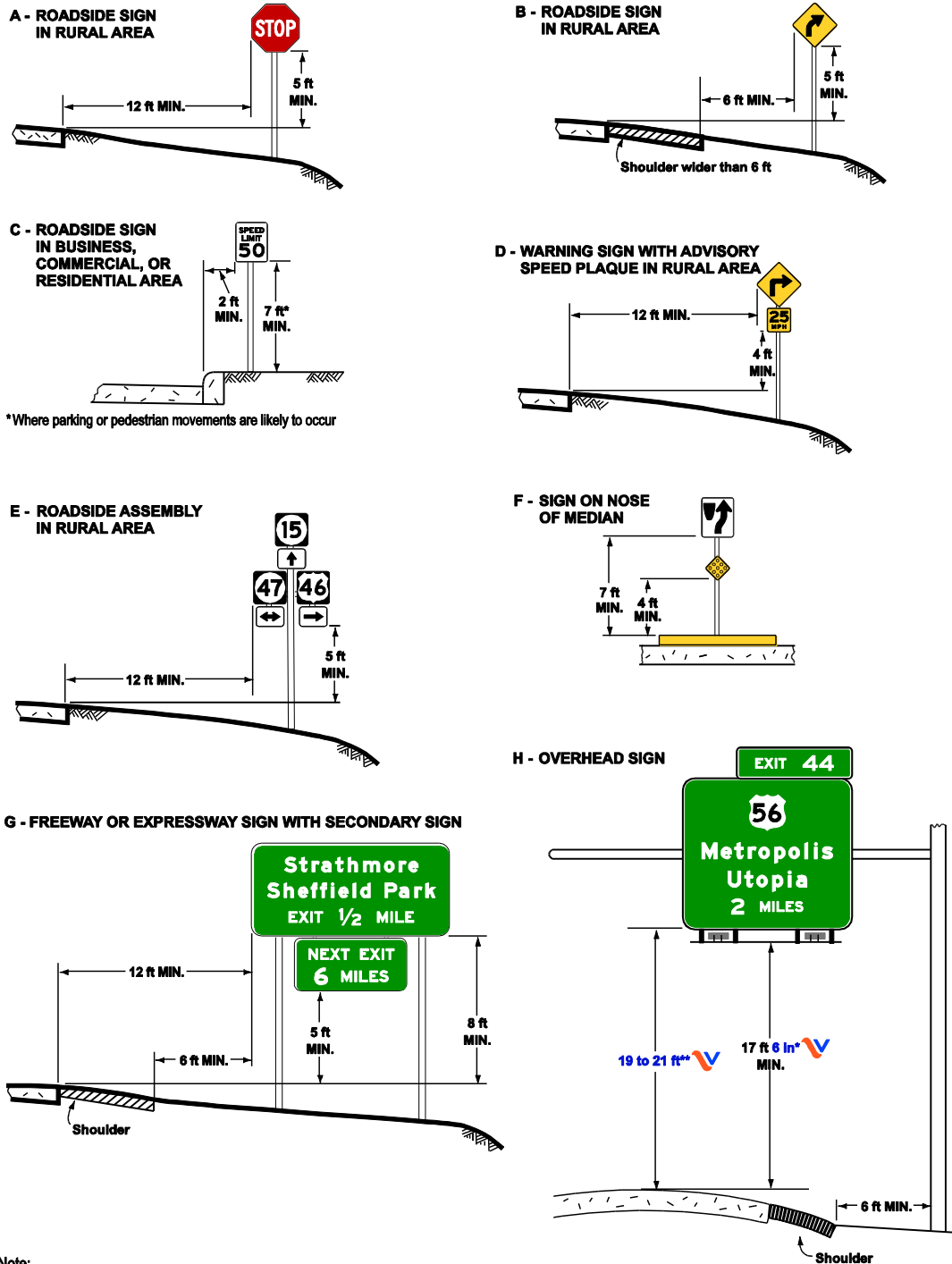
**Support:**

- 18 [Figure 2A-2\(VA\) in this Supplement](#) illustrates some examples of the mounting height requirements contained in this Section.



## Figure 2A-2(VA). Examples of Heights and Lateral Locations of Sign Installations

(This Figure has been updated for the Virginia Supplement to the MUTCD – Revision 1.)\*



Note:

See Section 2A.19 for reduced lateral offset distances that may be used in areas where lateral offsets are limited, and in business, commercial, or residential areas where sidewalk width is limited or where existing poles are close to the curb.

\* Luminaire assemblies or other hardware mounted below the sign panel should have a vertical clearance of no less than 17 feet 6 inches from the bottom of the hardware to the crown of the roadway. (See Section 2A.18)

\*\* 19 to 21 feet of vertical clearance to bottom of lowest mounted sign panel should be provided. (See section 2A.18)

## CHAPTER 2B. REGULATORY SIGNS, BARRICADES, AND GATES

### Section 2B.09 YIELD Sign Applications (This Section has been added to the Virginia Supplement to the MUTCD - Revision 1.)\*

Option:

01 YIELD signs may be installed:\*

- A. On the approaches to a through street or highway where conditions are such that a full stop is not always required.\*
- B. At the second crossroad of a divided highway, where the median width at the intersection is 30 feet or greater. In this case, a STOP or YIELD sign may be installed at the entrance to the first roadway of a divided highway, and a YIELD sign may be installed at the entrance to the second roadway.\*
- C. For a channelized turn lane that is separated from the adjacent travel lanes by an island, even if the adjacent lanes at the intersection are controlled by a highway traffic control signal or by a STOP sign.\*
- D. At an intersection where a special problem exists and where engineering judgment indicates the problem to be susceptible to correction by the use of the YIELD sign.\*

Guidance:

02 *In cases in which an acceleration lane exists, YIELD signs should only be used for the entering roadway for a merge-type movement when engineering judgment indicates that control is needed.\**

Option:

03 Engineering judgment may consider factors such as: limited sight distance on the entering roadway, inadequate acceleration lane length, or crash history.\*

Standard:

04 A YIELD (R1-2) sign shall be used to assign right-of-way at the entrance to a roundabout. YIELD signs at roundabouts shall be used to control the approach roadways and shall not be used to control the circulatory roadway.\*

05 Other than for all of the approaches to a roundabout, YIELD signs shall not be placed on all of the approaches to an intersection.\*



**Table 2B-1(VA). Regulatory Sign and Plaque Sizes**

Sign or Plaque	Sign Designation	Section	Conventional Road		Expressway	Freeway	Minimum	Oversized
			Single Lane	Multi-Lane				
Stop	R1-1	2B.05	30 x 30*	36 x 36	36 x 36	—	30 x 30*	48 x 48
Yield	R1-2	2B.08	36 x 36 x 36*	48 x 48 x 48	48 x 48 x 48	60 x 60 x 60	30 x 30 x 30*	—
To Oncoming Traffic (plaque)	R1-2aP	2B.10	24 x 18	24 x 18	36 x 30	48 x 36	24 x 18	—
All Way (plaque)	R1-3P	2B.05	18 x 6	18 x 6	—	—	—	30 x 12
Yield Here to Peds	R1-5	2B.11	—	36 x 36	—	—	—	36 x 36
Yield Here to Pedestrians	R1-5a	2B.11	—	36 x 48	—	—	—	36 x 48
Stop Here for Peds	R1-5b	2B.11	—	36 x 36	—	—	—	36 x 36
Stop Here for Pedestrians	R1-5c	2B.11	—	36 x 48	—	—	—	36 x 48
In-Street Ped Crossing	R1-6,6a	2B.12	12 x 36	12 x 36	—	—	—	—
Overhead Ped Crossing	R1-9,9a	2B.12	90 x 24	90 x 24	—	—	—	—
Except Right Turn (plaque)	R1-10P	2B.05	24 x 18	24 x 18	—	—	—	—
Speed Limit	R2-1	2B.13	24 x 30*	30 x 36	36 x 48	48 x 60	18 x 24*	30 x 36
Truck Speed Limit (plaque)	R2-2P	2B.14	24 x 24	24 x 24	36 x 36	48 x 48	—	36 x 36
Night Speed Limit (plaque)	R2-3P	2B.15	24 x 24	24 x 24	36 x 36	48 x 48	—	36 x 36
Minimum Speed Limit (plaque)	R2-4P	2B.16	24 x 30	24 x 30	36 x 48	48 x 60	—	36 x 48
Combined Speed Limit	R2-4a	2B.16	24 x 48	24 x 48	36 x 72	48 x 96	—	36 x 72
Unless Otherwise Posted (plaque)	R2-5P	2B.13	24 x 18	24 x 18	—	—	—	—
Citywide (plaque)	R2-5aP	2B.13	24 x 6	24 x 6	—	—	—	—
Neighborhood (plaque)	R2-5bP	2B.13	24 x 6	24 x 6	—	—	—	—
Residential (plaque)	R2-5cP	2B.13	24 x 6	24 x 6	—	—	—	—
Fines Higher (plaque)	R2-6P	2B.17	24 x 18	24 x 18	36 x 24	48 x 36	—	36 x 24
Fines Double (plaque)	R2-6aP	2B.17	24 x 18	24 x 18	36 x 24	48 x 36	—	36 x 24
\$XX Fine (plaque)	R2-6bP	2B.17	24 x 18	24 x 18	36 x 24	48 x 36	—	36 x 24
Begin Higher Fines Zone	R2-10	2B.17	24 x 30	24 x 30	36 x 48	48 x 60	—	36 x 48
End Higher Fines Zone	R2-11	2B.17	24 x 30	24 x 30	36 x 48	48 x 60	—	36 x 48
Movement Prohibition	R3-1,2,3,4,18,27	2B.18	24 x 24*	36 x 36	36 x 36	—	—	48 x 48
Mandatory Movement Lane Control	R3-5,5a	2B.20	30 x 36	30 x 36	—	—	—	—
Left Lane (plaque)	R3-5bP	2B.20	30 x 12	30 x 12	—	—	—	—
HOV 2+ (plaque)	R3-5cP	2B.20	24 x 12	24 x 12	—	—	—	—
Taxi Lane (plaque)	R3-5dP	2B.20	30 x 12	30 x 12	—	—	—	—
Center Lane (plaque)	R3-5eP	2B.20	30 x 12	30 x 12	—	—	—	—

Sign or Plaque	Sign Designation	Section	Conventional Road		Expressway	Freeway	Minimum	Oversized
			Single Lane	Multi-Lane				
Right Lane (plaque)	R3-5fP	2B.20	30 x 12	30 x 12	—	—	—	—
Bus Lane (plaque)	R3-5gP	2B.20	30 x 12	30 x 12	—	—	—	—
Optional Movement Lane Control	R3-6	2B.21	30 x 36	30 x 36	—	—	—	—
Right (Left) Lane Must Turn Right (Left)	R3-7	2B.20	30 x 30*	36 x 36	—	—	—	—
Advance Intersection Lane Control	R3-8,8a,8b	2B.22	Varies x 30	Varies x 30	—	—	—	Varies x 36
Two-Way Left Turn Only (overhead)	R3-9a	2B.24	30 x 36	30 x 36	—	—	—	—
Two-Way Left Turn Only (post-mounted)	R3-9b	2B.24	24 x 36	24 x 36	—	—	—	36 x 48
BEGIN	R3-9cP	2B.25	30 x 12	30 x 12	—	—	—	—
BEGIN	R3-9cP (V)	2B.V3	—	—	48 x 18	48 x 18	—	—
END	R3-9dP	2B.25	30 x 12	30 x 12	—	—	—	—
Reversible Lane Control (symbol)	R3-9e	2B.26	108 x 48	108 x 48	—	—	—	—
Reversible Lane Control (post-mounted)	R3-9f	2B.26	30 x 42*	36 x 54	—	—	—	—
Advance Reversible Lane Control Transition Signing	R3-9g,9h	2B.26	108 x 36	108 x 36	—	—	—	—
End Reverse Lane	R3-9i	2B.26	108 x 48	108 x 48	—	—	—	—
Begin Right (Left) Turn Lane	R3-20	2B.20	24 x 36	24 x 36	—	—	—	—
All Turns (U Turn) from Right Lane	R3-23,23a	2B.27	60 x 36	60 x 36	—	—	—	—
All Turns (U Turn) with arrow	R3-24,24b,25,25b,26a	2B.27	72 x 18	72 x 18	—	—	—	—
U and Left Turns with arrow	R3-24a,25a,26	2B.27	60 x 24	60 x 24	—	—	—	—
Right Lane Must Exit	R3-33	2B.23	—	—	78 x 36	78 x 36	—	—
Do Not Pass	R4-1	2B.28	24 x 30	24 x 30	36 x 48	48 x 60	18 x 24	36 x 48
Pass With Care	R4-2	2B.29	24 x 30	24 x 30	36 x 48	48 x 60	18 x 24	36 x 48
Slower Traffic Keep Right	R4-3	2B.30	24 x 30	24 x 30	36 x 48	48 x 60	18 x 24	36 x 48
Trucks Use Right Lane	R4-5	2B.31	24 x 30	24 x 30	36 x 48	48 x 60	—	36 x 48
Keep Right	R4-7,7a,7b	2B.32	24 x 30	24 x 30	36 x 48	48 x 60	18 x 24	36 x 48
Narrow Keep Right	R4-7c	2B.32	18 x 30	18 x 30	—	—	—	—
Keep Left	R4-8,8a,8b	2B.32	24 x 30	24 x 30	36 x 48	48 x 60	18 x 24	36 x 48
Narrow Keep Left	R4-8c	2B.32	18 x 30	18 x 30	—	—	—	—
Stay in Lane	R4-9	2B.33	24 x 30	24 x 30	36 x 48	48 x 60	18 x 24	36 x 48
Runaway Vehicles Only	R4-10	2B.34	48 x 48	48 x 48	—	—	—	—
Slow Vehicles with XX or More Following Vehicles Must Use Turn-Out	R4-12	2B.35	42 x 24	42 x 24	—	—	—	—
Slow Vehicles Must Use Turn-Out Ahead	R4-13	2B.35	42 x 24	42 x 24	—	—	—	—

Sign or Plaque	Sign Designation	Section	Conventional Road		Expressway	Freeway	Minimum	Oversized
			Single Lane	Multi-Lane				
Slow Vehicles Must Turn Out	R4-14	2B.35	30 x 42	30 x 42	—	—	—	—
Keep Right Except to Pass	R4-16	2B.30	24 x 30	24 x 30	36 x 48	48 x 60	18 x 24	36 x 48
Do Not Drive on Shoulder	R4-17	2B.36	24 x 30	24 x 30	36 x 48	48 x 60	18 x 24	36 x 48
Do Not Pass on Shoulder	R4-18	2B.36	24 x 30	24 x 30	36 x 48	48 x 60	18 x 24	36 x 48
Do Not Enter	R5-1	2B.37	30 x 30*	36 x 36	36 x 36	48 x 48	—	36 x 36
Wrong Way	R5-1a	2B.38	36 x 24*	42 x 30	36 x 24*	42 x 30	30 x 18*	42 x 30
No Trucks	R5-2,2a	2B.39	24 x 24	24 x 24	30 x 30	36 x 36	—	36 x 36
No Motor Vehicles	R5-3	2B.39	24 x 24	24 x 24	—	—	24 x 24	—
No Commercial Vehicles	R5-4	2B.39	24 x 30	24 x 30	36 x 48	36 x 48	—	—
No Vehicles with Lugs	R5-5	2B.39	24 x 30	24 x 30	36 x 48	48 x 60	—	—
No Bicycles	R5-6	2B.39	24 x 24	24 x 24	30 x 30	36 x 36	24 x 24	48 x 48
No Non-Motorized Traffic	R5-7	2B.39	30 x 24	30 x 24	42 x 24	48 x 30	—	42 x 24
No Motor-Driven Cycles	R5-8	2B.39	30 x 24	30 x 24	42 x 24	48 x 30	—	42 x 24
No Pedestrians, Bicycles, Motor-Driven Cycles	R5-10a	2B.39	30 x 36	30 x 36	—	—	—	—
No Pedestrians or Bicycles	R5-10b	2B.39	30 x 18	30 x 18	—	—	—	—
No Pedestrians	R5-10c	2B.39	24 x 12	24 x 12	—	—	—	—
Authorized Vehicles Only	R5-11	2B.39	30 x 24	30 x 24	—	—	—	—
AUTHORIZED VEHICLES ONLY	R5-11 (V)	2B.39	36 x 24	36 x 24	36 x 24	36 x 24	—	—
One Way	R6-1	2B.40	36 x 12*	54 x 18	54 x 18	54 x 18	—	54 x 18
One Way	R6-2	2B.40	24 x 30*	30 x 36	36 x 48	48 x 60	18 x 24*	36 x 48
Divided Highway Crossing	R6-3,3a	2B.42	30 x 24	30 x 24	36 x 30	—	—	36 x 30
Roundabout Directional (2 chevrons)	R6-4	2B.43	30 x 24	30 x 24	—	—	—	—
Roundabout Directional (3 chevrons)	R6-4a	2B.43	48 x 24	48 x 24	—	—	—	—
Roundabout Directional (4 chevrons)	R6-4b	2B.43	60 x 24	60 x 24	—	—	—	—
Roundabout Circulation (plaque)	R6-5P	2B.44	30 x 30	30 x 30	—	—	—	—
BEGIN ONE WAY	R6-6	2B.40	24 x 30	30 x 36	—	—	—	—
END ONE WAY	R6-7	2B.40	24 x 30	30 x 36	—	—	—	—
Parking Restrictions	R7-1,2,2a,3,4,5,6,7,8,21,21a,22,23,23a,107,108	2B.46	12 x 18	12 x 18	—	—	—	—
Van Accessible (plaque)	R7-8P	2B.46	18 x 9	18 x 9	—	—	—	—
Fee Station	R7-20	2B.46	24 x 18	24 x 18	—	—	—	—
No Parking (with transit logo)	R7-107a	2B.46	12 x 30	12 x 30	—	—	—	—

Sign or Plaque	Sign Designation	Section	Conventional Road		Expressway	Freeway	Minimum	Oversized
			Single Lane	Multi-Lane				
No Parking/Restricted Parking (combined sign)	R7-200	2B.46	24 x 18	24 x 18	—	—	—	—
No Parking/Restricted Parking (combined sign)	R7-200a	2B.46	12 x 30	12 x 30	—	—	—	—
Tow Away Zone (plaque)	R7-201P,201aP	2B.46	12 x 6	12 x 6	—	—	—	—
This Side of Sign (plaque)	R7-202P	2B.46	12 x 6	12 x 6	—	—	—	—
Emergency Snow Route	R7-203	2B.46	18 x 24	18 x 24	—	—	—	24 x 30
No Parking on Pavement	R8-1	2B.46	24 x 30	24 x 30	36 x 48	48 x 60	—	36 x 48
No Parking Except on Shoulder	R8-2	2B.46	24 x 30	24 x 30	36 x 48	48 x 60	—	36 x 48
No Parking (symbol)	R8-3	2B.46	24 x 24*	30 x 30	36 x 36	48 x 48	12 x 12*	36 x 36
No Parking	R8-3a	2B.46	24 x 30	24 x 30	36 x 36	48 x 48	18 x 24	36 x 36
Except Sundays and Holidays (plaque)	R8-3bP	2B.46	24 x 18	24 x 18	—	—	12 x 9	30 x 24
On Pavement (plaque)	R8-3cP	2B.46	24 x 18	24 x 18	—	—	12 x 9	30 x 24
On Bridge (plaque)	R8-3dP	2B.46	24 x 18	24 x 18	—	—	12 x 9	30 x 24
On Tracks (plaque)	R8-3eP	2B.46	12 x 9	12 x 9	—	—	—	30 x 24
Except on Shoulder (plaque)	R8-3fP	2B.46	24 x 18	24 x 18	—	—	12 x 9	30 x 24
Loading Zone (plaque)	R8-3gP	2B.46	24 x 18	24 x 18	—	—	12 x 9	30 x 24
Times of Day (plaque)	R8-3hP	2B.46	24 x 18	24 x 18	—	—	12 x 9	30 x 24
Emergency Parking Only	R8-4	2B.49	30 x 24	30 x 24	30 x 24	48 x 36	—	48 x 36
No Stopping on Pavement	R8-5	2B.46	24 x 30	24 x 30	36 x 48	48 x 60	—	36 x 48
No Stopping Except on Shoulder	R8-6	2B.46	24 x 30	24 x 30	36 x 48	48 x 60	—	36 x 48
Emergency Stopping Only	R8-7	2B.49	30 x 24	30 x 24	48 x 36	48 x 36	—	48 x 36
Walk on Left Facing Traffic	R9-1	2B.50	18 x 24	18 x 24	—	—	—	—
Cross Only at Crosswalks	R9-2	2B.51	12 x 18	12 x 18	—	—	—	—
No Pedestrian Crossing (symbol)	R9-3	2B.51	18 x 18	18 x 18	24 x 24	30 x 30	—	30 x 30
No Pedestrian Crossing	R9-3a	2B.51	12 x 18	12 x 18	—	—	—	—
Use Crosswalk (plaque)	R9-3bP	2B.51	18 x 12	18 x 12	—	—	—	—
No Hitchhiking (symbol)	R9-4	2B.50	18 x 18	18 x 18	—	—	—	24 x 24
No Hitchhiking	R9-4a	2B.50	18 x 24	18 x 24	—	—	12 x 18	—
No Skaters	R9-13	2B.39	18 x 18	18 x 18	24 x 24	30 x 30	—	30 x 30
No Equestrians	R9-14	2B.39	18 x 18	18 x 18	24 x 24	30 x 30	—	30 x 30
Cross Only On Green	R10-1	2B.52	12 x 18	12 x 18	—	—	—	—
Pedestrian Signs and Plaques	R10-2,3,3b,3c,3d,4	2B.52	9 x 12	9 x 12	—	—	—	—

Sign or Plaque	Sign Designation	Section	Conventional Road		Expressway	Freeway	Minimum	Oversized
			Single Lane	Multi-Lane				
Pedestrian Signs	R10-3a,3e,3f,3g,3h,3i,4a	2B.52	9 x 15	9 x 15	—	—	—	—
Left on Green Arrow Only	R10-5	2B.53	30 x 36	30 x 36	48 x 60	—	24 x 30	48 x 60
Stop Here on Red	R10-6	2B.53	24 x 36	24 x 36	—	—	—	36 x 48
Stop Here on Red	R10-6a	2B.53	24 x 30	24 x 30	—	—	—	36 x 42
Do Not Block Intersection	R10-7	2B.53	24 x 30	24 x 30	—	—	—	—
Use Lane with Green Arrow	R10-8	2B.53	36 x 42	36 x 42	36 x 42	—	—	60 x 72
Left (Right) Turn Signal	R10-10	2B.53	30 x 36	30 x 36	—	—	—	—
No Turn on Red	R10-11	2B.54	24 x 30*	36 x 48	—	—	—	36 x 48
No Turn on Red	R10-11a	2B.54	30 x 36*	36 x 48	—	—	—	—
No Turn on Red	R10-11b	2B.54	36 x 36	36 x 36	—	—	—	—
No Turn on Red Except From Right Lane	R10-11c	2B.54	30 x 42	30 x 42	—	—	—	—
No Turn on Red From This Lane	R10-11d	2B.54	30 x 42	30 x 42	—	—	—	—
Left Turn Yield on Green	R10-12	2B.53	30 x 36	30 x 36	—	—	—	—
Emergency Signal	R10-13	2B.53	42 x 30	42 x 30	—	—	—	—
Emergency Signal - Stop on Flashing Red	R10-14	2B.53	36 x 42	36 x 42	—	—	—	—
Emergency Signal - Stop on Flashing Red (overhead)	R10-14a	2B.53	60 x 24	60 x 24	—	—	—	—
Stop Here on Flashing Red	R10-14b	2B.53	24 x 36	24 x 36	—	—	—	36 x 48
Turning Vehicles Yield to Peds	R10-15	2B.53	30 x 30	30 x 30	—	—	—	—
U-Turn Yield to Right Turn	R10-16	2B.53	30 x 36	30 x 36	—	—	—	—
Right on Red Arrow After Stop	R10-17a	2B.54	36 x 48	36 x 48	—	—	—	—
Traffic Laws Photo Enforced	R10-18	2B.55	36 x 24	36 x 24	48 x 30	54 x 36	—	54 x 36
Traffic Signal - PHOTO ENFORCED	R10-18a	2B.55	30 x 42	30 x 42	30 x 42	—	—	—
Photo Enforced (symbol plaque)	R10-19P	2B.55	24 x 12	24 x 12	36 x 18	48 x 24	—	48 x 24
Photo Enforced (plaque)	R10-19aP	2B.55	24 x 18	24 x 18	36 x 30	48 x 36	—	48 x 36
MON—FRI (and times) (3 lines) (plaque)	R10-20aP	2B.53	24 x 24	24 x 24	—	—	—	—
SUNDAY (and times) (2 lines) (plaque)	R10-20aP	2B.53	24 x 18	24 x 18	—	—	—	—
Crosswalk, Stop on Red	R10-23	2B.53	24 x 30	24 x 30	—	—	—	—
Pedestrian Signs and Plaques	R10-25	2B.52	9 x 12	9 x 12	—	—	—	—
Left Turn Yield on Flashing Red Arrow After Stop	R10-27	2B.53	30 x 36	30 x 36	—	—	—	—
XX Vehicles Per Green	R10-28	2B.56	24 x 30	24 x 30	—	—	—	—
XX Vehicles Per Green Each Lane	R10-29	2B.56	36 x 24	36 x 24	—	—	—	—



Sign or Plaque	Sign Designation	Section	Conventional Road		Expressway	Freeway	Minimum	Oversized
			Single Lane	Multi-Lane				
Right Turn on Red Must Yield to U-Turn	R10-30	2B.54	30 x 36	30 x 36	—	—	—	—
At Signal (plaque)	R10-31P	2B.53	24 x 9	24 x 9	—	—	—	—
Push Button for 2 Seconds for Extra Crossing Time	R10-32P	2B.52	9 x 12	9 x 12	—	—	—	—
Keep Off Median	R11-1	2B.57	24 x 30	24 x 30	—	—	—	—
Road Closed	R11-2	2B.58	48 x 30	48 x 30	—	—	—	—
Road Closed - Local Traffic Only	R11-3a,3b,4	2B.58	60 x 30	60 x 30	—	—	—	—
Weight Limit	R12-1,2	2B.59	24 x 30	24 x 30	36 x 48	—	—	36 x 48
Weight Limit	R12-3	2B.59	24 x 36	24 x 36	—	—	—	—
Weight Limit	R12-4	2B.59	36 x 24	36 x 24	—	—	—	—
Weight Limit	R12-5	2B.59	24 x 36	24 x 36	36 x 48	48 x 60	—	—
WEIGHT LIMIT Symbol	R12-V1	2B.59	24 x 30	30 x 36	36 x 42	48 x 54	—	—
Weigh Station	R13-1	2B.60	72 x 54	72 x 54	96 x 72	120 x 90	—	—
Truck Route	R14-1	2B.61	24 x 18	24 x 18	—	—	—	—
Hazardous Material	R14-2,3	2B.62	24 x 24	24 x 24	30 x 30	36 x 36	—	42 x 42
National Network	R14-4,5	2B.63	30 x 30	30 x 30	36 x 36	36 x 36	—	42 x 42
Fender Bender Move Vehicles	R16-4	2B.65	36 x 24	36 x 24 48 x 36	48 x 36 60 x 48	60 x 48	—	48 x 36
FENDER BENDER MOVE VEHICLES	R16-4 (V)	2B.65	—	—	—	120 x 60	—	—
Lights On When Using Wipers or Raining	R16-5,6	2B.64	24 x 30	24 x 30	36 x 48	48 x 60	—	36 x 48
Turn On Headlights Next XX Miles	R16-7	2B.64	48 x 15	48 x 15	72 x 24	96 x 30	—	72 x 24
Turn On, Check Headlights	R16-8,9	2B.64	30 x 15	30 x 15	48 x 24	60 x 30	—	48 x 24
Begin, End Daytime Headlight Section	R16-10,11	2B.64	48 x 15	48 x 15	72 x 24	96 x 30	—	72 x 24
<b>Virginia Specific Signs</b>								
NO DUMPING	R0-V1	2B.V1	24 x 24	24 x 24	—	—	—	—
LITTERING IS ILLEGAL	R0-V2	2B.V1	30 x 30	36 x 36	48 x 48	48 x 48	—	—
SPEED CHECKED BY RADAR AND OTHER ELECTRICAL DEVICES	R0-V3	2B.V2	54 x 30	96 x 42	126 x 54	126 x 54	—	—
RADAR DETECTORS ILLEGAL	R0-V4	2B.V2	54 x 36	54 x 36	72 x 48	72 x 48	—	—
HIGHWAY SAFETY CORRIDOR FINES	R0-V5	2B.V3	120 x 48	120 x 48	180 x 72	180 x 72	—	—
END HIGHWAY SAFETY CORRIDOR	R0-V6	2B.V3	72 x 24	72 x 24	144 x 48	144 x 48	—	—
SPEED LIMIT ENFORCED BY AIRCRAFT	R0-V7	2B.V2	—	—	90 x 54	90 x 54	—	—
TRUCKS-BUSES ALL TOWED VEHICLES CARS ONLY Rest Area Sign	R0-V8	2B.V4	—	—	114 x 36	114 x 36	—	—



Sign or Plaque	Sign Designation	Section	Conventional Road		Expressway	Freeway	Minimum	Oversized
			Single Lane	Multi-Lane				
END XX MILE SPEED	R2-V2	2B.13	24 x 30	30 x 36	—	—	—	—
TOWED VEHICLES Speed Limit (plaque)	R2-VP1	2B.V5	24 x 30	30 x 36	36 x 48	48 x 60	—	—
Optional U-Turn/Left Turn	R3-V1	2B.21	30 x 36	30 x 36	—	—	—	—
COMMERCIAL VEHICLES EXCEPT BUSES USE RIGHT LANE WHEN OPERATED XX MPH OR BELOW	R4-V1	2B.V7	—	144 x 84	144 x 84	144 x 84	—	—
COMMERCIAL VEHICLES EXCEPT BUSES PROHIBITED IN LEFT LANE	R4-V2	2B.V7	—	90 x 48	144 x 72	144 x 72	—	—
COMMERCIAL VEHICLES EXCEPT BUSES PROHIBITED IN LEFT LANE (Reduced Width)	R4-V2a	2B.V7	—	60 x 54	108 x 84	108 x 84	—	—
END COMMERCIAL VEHICLE RESTRICTION	R4-V3	2B.V7	—	108 x 48	108 x 48	108 x 48	—	—
TRUCKS AND COMBINATION VEHICLES USE RIGHT LANE WHEN OPERATED BELOW XX MPH	R4-V4	2B.V7	—	144 x 84	144 x 84	144 x 84	—	—
NO PEDESTRIANS, BICYCLES, MOPEDS, ANIMALS, SELF-PROPELLED MACHINERY OR EQUIPMENT	R5-V2	2B.39	—	—	36 x 48	36 x 48	—	—
STATE POLICE PARKING ONLY	R7-V1	2B.46	24 x 30	24 x 30	24 x 30	24 x 30	—	—
TOW-AWAY ZONE PENALTY \$100-\$500 FINE (plaque)	R7-VP1	2B.46	12 x 9	12 x 9	—	—	—	—
UNATTENDED VEHICLES SUBJECT TO TOWING AT OWNER'S EXPENSE (plaque)	R8-VP1	2B.49	48 x 24	48 x 24	48 x 24	48 x 24	—	—
NO FISHING FROM BRIDGE	R9-V1	2B.V6	18 x 24	18 x 24	—	—	—	—
Pedestrian Swing Bridge	R9-V2	2B.V8	—	—	—	—	12 x 18	—
LEFT TURN YIELD ON FLASHING YELLOW ARROW	R10-V1	2B.53	36 x 42	36 x 42	36 x 42	—	30 x 30	—
BRIDGE (plaque)	R12-VP1	2B.59	24 x 12	30 x 15	36 x 18	36 x 18	—	—

\* See Table 9B-1(VA) in this Supplement for minimum size required for signs on bicycle facilities

Notes:

1. Larger signs may be used when appropriate
2. Dimensions in inches are shown as width x height

## **Section 2B.11 Yield Here To Pedestrians Signs and Stop Here For Pedestrians Signs (R1-5 Series)**



### Support:

- 01 The Code of Virginia § 46.2-924 requires that drivers at crosswalks yield the right-of-way to pedestrians crossing the highway. The Standard statement in Section 2B.11 of the National MUTCD permits the use of the Stop Here for Pedestrians (R1-5b and R1-5c) signs only if state law specifically requires the driver to stop for a pedestrian in a crosswalk. As The Code of Virginia does not require a driver to stop, the R1-5b and R1-5c signs are not used in Virginia.

### Standard:

- 02 **Yield Here To Pedestrians (R1-5 or R1-5a) signs (see Figure 2B-2(VA) in this Supplement) shall be used if yield lines are used in advance of a marked crosswalk that crosses an uncontrolled multi-lane approach. The Stop Here for Pedestrians (R1-5b and R1-5c) signs shall not be used in Virginia. The legend STATE LAW may be displayed at the top of the R1-6 and R1-9 signs.**

### Guidance:

- 03 *If yield lines and Yield Here To Pedestrians signs are used in advance of a crosswalk that crosses an uncontrolled multi-lane approach, they should be placed 20 to 50 feet in advance of the nearest crosswalk line (see Section 3B.16 and Figure 3B-17(VA) in this Supplement), and parking should be prohibited in the area between the yield (stop) line and the crosswalk.*
- 04 *Yield lines and Yield Here To Pedestrians signs should not be used in advance of crosswalks that cross an approach to or departure from a roundabout.*

### Option:

- 05 Yield Here to Pedestrians signs may be used in advance of a crosswalk that crosses an uncontrolled multi-lane approach to indicate to road users where to yield even if yield lines are not used.
- 06 A Pedestrian Crossing (W11-2) warning sign may be placed overhead or may be post-mounted with a diagonal downward pointing arrow (W16-7P) plaque at the crosswalk location where Yield Here To Pedestrians signs have been installed in advance of the crosswalk.

### Standard:

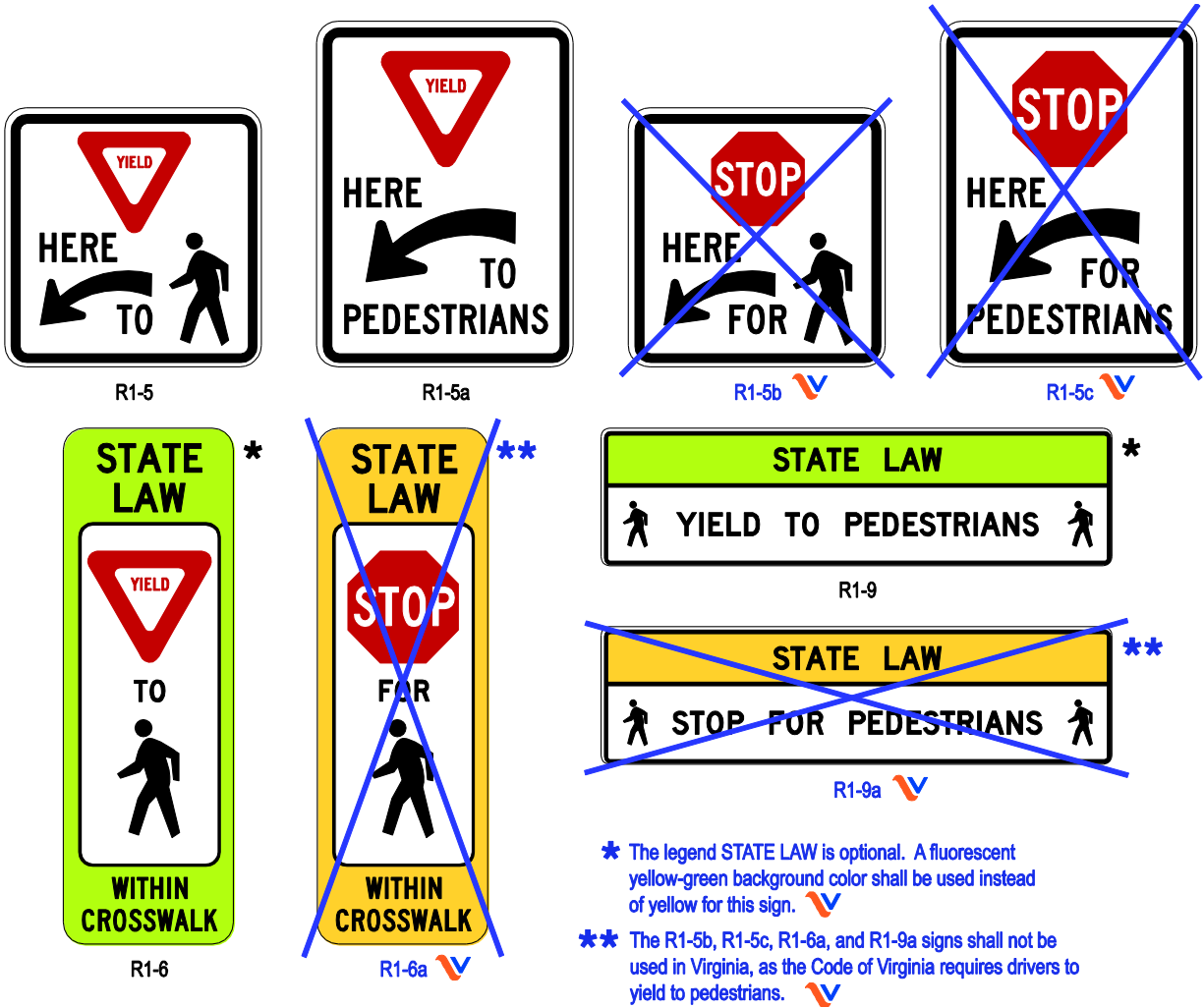
- 07 **If a W11-2 sign has been post-mounted at the crosswalk location where a Yield Here To Pedestrians sign is used on the approach, the Yield Here To Pedestrians sign shall not be placed on the same post as or block the road user's view of the W11-2 sign.**

### Option:

- 08 An advance Pedestrian Crossing (W11-2) warning sign with an AHEAD or a distance supplemental plaque may be used in conjunction with a Yield Here To Pedestrians sign on the approach to the same crosswalk.

- 09 In-Street Pedestrian Crossing signs and Yield Here To Pedestrians signs may be used together at the same crosswalk.

**Figure 2B-2(VA). Unsignalized Pedestrian Crossing Signs**



## **Section 2B.12 In-Street and Overhead Pedestrian Crossing Signs (R1-6, R1-6a, R1-9, and R1-9a)**



### Option:

- 01 The In-Street Pedestrian Crossing (R1-6) sign (see Figure 2B-2(VA) in this Supplement) or the Overhead Pedestrian Crossing (R1-9) sign (see Figure 2B-2(VA) in this Supplement) may be used to remind road users of laws regarding right-of-way at an unsignalized pedestrian crosswalk. The legend STATE LAW may be displayed at the top of the R1-6 and R1-9 signs.

### Support:

- 02 The Code of Virginia § 46.2-924 requires that drivers at crosswalks yield the right-of-way to pedestrians crossing the highway. The Standard statement in Section 2B.12 of the National MUTCD permits the use of the Stop for Pedestrians (R1-6a and R1-9a) signs only if state law specifically requires the driver to stop for a pedestrian in a crosswalk. As The Code of Virginia does not require a driver to stop, the R1-6a and R1-9a signs are not used in Virginia.

### Standard:

- 03 **The Stop For Pedestrians In-Street Pedestrian Crossing (R1-6a) and Stop for Pedestrians Overhead Pedestrian Crossing (R1-9a) signs shall not be used in Virginia.**

### Option:

- 04 On the R1-6 sign, the legend YIELD may be used instead of the appropriate YIELD sign symbol.
- 05 Highway agencies may develop and apply criteria for determining the applicability of In-Street Pedestrian Crossing signs.

### Standard:

- 06 **If used, the In-Street Pedestrian Crossing sign shall be placed in the roadway at the crosswalk location on the center line, on a lane line, or on a median island. The In-Street Pedestrian Crossing sign shall not be post-mounted on the left-hand or right-hand side of the roadway.**
- 07 **If used, the Overhead Pedestrian Crossing sign shall be placed over the roadway at the crosswalk location.**
- 08 **An In-Street or Overhead Pedestrian Crossing sign shall not be placed in advance of the crosswalk to educate road users about the State law prior to reaching the crosswalk, nor shall it be installed as an educational display that is not near any crosswalk.**

### Guidance:

- 09 *If an island (see Chapter 3I) is available, the In-Street Pedestrian Crossing sign, if used, should be placed on the island.*

### Option:

- 10 If a Pedestrian Crossing (W11-2) warning sign is used in combination with an In-Street or an Overhead Pedestrian Crossing sign, the W11-2 sign with a diagonal downward

pointing arrow (W16-7P) plaque may be post-mounted on the right-hand side of the roadway at the crosswalk location.

**Standard:**

- 11 **The In-Street Pedestrian Crossing sign and the Overhead Pedestrian Crossing sign shall not be used at signalized locations.**
- 12 **The In-Street Pedestrian Crossing sign shall have a black legend (except for the red YIELD sign symbols) and border on a white background, surrounded by an outer ~~yellow-or~~ fluorescent yellow-green background area (see [Figure 2B-2\(VA\) in this Supplement](#)). The Overhead Pedestrian Crossing sign shall have a black legend and border on a ~~yellow-or~~ fluorescent yellow-green background at the top of the sign and a black legend and border on a white background at the bottom of the sign (see [Figure 2B-2\(VA\) in this Supplement](#)).**
- 13 **Unless the In-Street Pedestrian Crossing sign is placed on a physical island, the sign support shall be designed to bend over and then bounce back to its normal vertical position when struck by a vehicle.**

**Support:**

- 14 The Provisions of [Section 2A.18 of this Supplement](#) concerning mounting height are not applicable for the In-Street Pedestrian Crossing sign.

**Standard:**

- 15 **The top of an In-Street Pedestrian Crossing sign shall be a maximum of 4 feet above the pavement surface. The top of an In-Street Pedestrian Crossing sign placed in an island shall be a maximum of 4 feet above the island surface.**

**Option:**

- 16 The In-Street Pedestrian Crossing sign may be used seasonally to prevent damage in winter because of plowing operations, and may be removed at night if the pedestrian activity at night is minimal.
- 17 In-Street Pedestrian Crossing signs, Overhead Pedestrian Crossing signs, and [Yield Here To Pedestrians](#) signs may be used together at the same crosswalk.



## **Section 2B.13 Speed Limit and End XX Mile Speed Signs (R2-1, R2-V2)**

**Standard:**

- 01 **Speed zones (other than statutory speed limits) shall only be established on the basis of an engineering study that has been performed in accordance with traffic engineering practices. The engineering study shall include an analysis of the current speed distribution of free-flowing vehicles.**
- 02 **The Speed Limit (R2-1) sign (see [Figure 2B-3\(VA\) in this Supplement](#)) shall display the limit established by law, ordinance, regulation, or as adopted by the authorized**


**agency based on the engineering study. The speed limits displayed shall be in multiples of 5 mph.**

- 03 **Speed Limit (R2-1) signs, indicating speed limits for which posting is required by law, shall be located at the points of change from one speed limit to another.**
- 04 **At the downstream end of the section to which a speed limit applies, a Speed Limit sign showing the next speed limit shall be installed. Additional Speed Limit signs shall be installed beyond major intersections and at other locations where it is necessary to remind road users of the speed limit that is applicable.**
- 05 **Speed Limit signs indicating the statutory speed limits shall be installed at entrances to the State and, where appropriate, at jurisdictional boundaries in urban areas.**

Support:

- 06 In general, the maximum speed limits applicable to rural and urban roads are established:
- A. Statutorily – a maximum speed limit applicable to a particular class of road, such as freeways or city streets, that is established by State law; or
  - B. As altered speed zones – based on engineering studies.

Option:

- 
- 07 **At the downstream end of a section to which a speed limit applies where the next section is governed by a statutorily established speed limit, the END XX MILE SPEED (R2-V2) sign (see Figure 2B-3(VA) in this Supplement) showing the previous speed limit may be installed.**

Support:

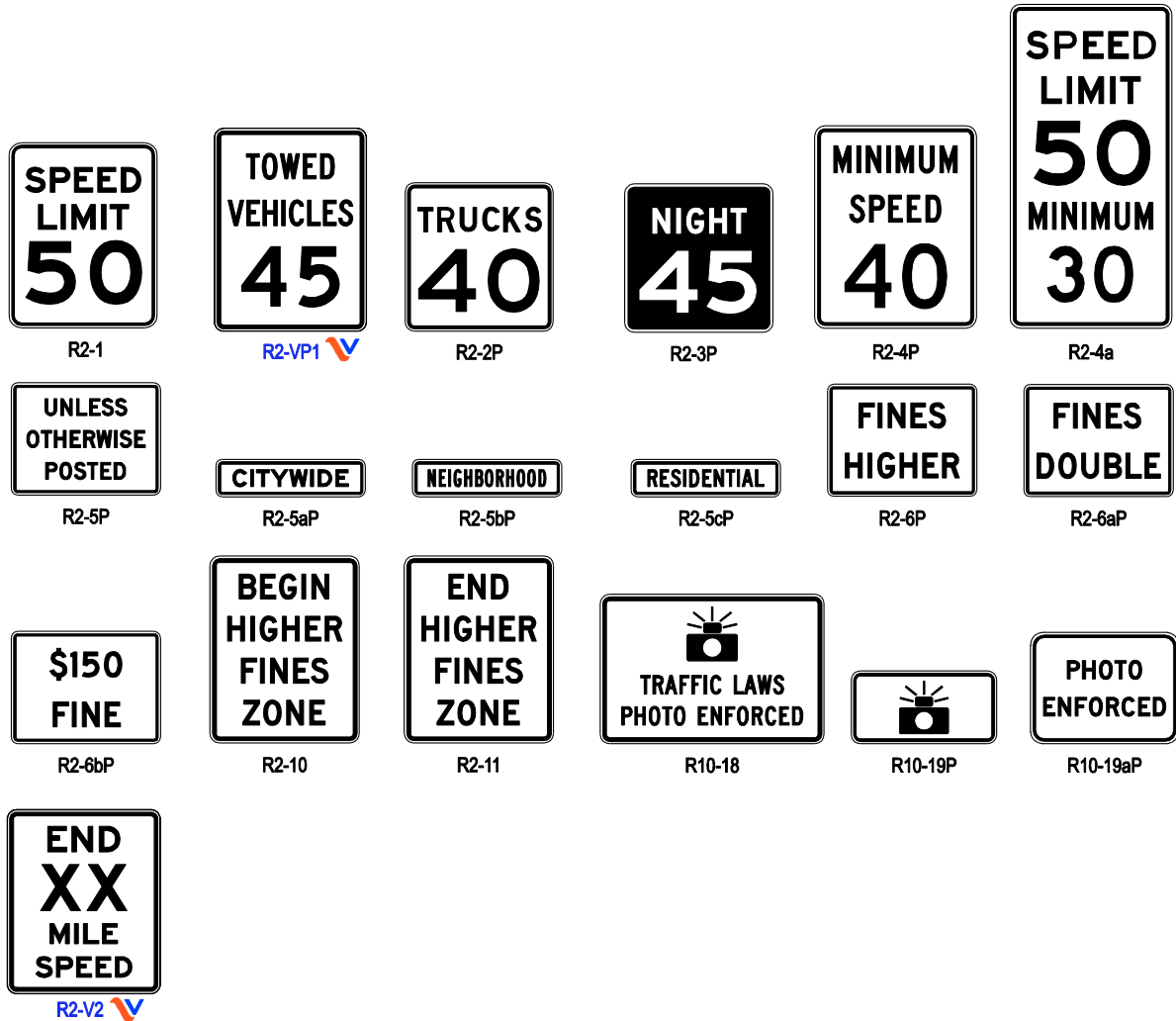
- 08 State statutory limits might restrict the maximum speed limit that can be established on a particular road, notwithstanding what an engineering study might indicate.

Option:

- 09 If a jurisdiction has a policy of installing Speed Limit signs in accordance with statutory requirements only on the streets that enter a city, neighborhood, or residential area to indicate the speed limit that is applicable to the entire city, neighborhood, or residential area unless otherwise posted, a CITYWIDE (R2-5aP), NEIGHBORHOOD (R2-5bP), or RESIDENTIAL (R2-5cP) plaque may be mounted above the Speed Limit sign and an UNLESS OTHERWISE POSTED (R2-5P) plaque may be mounted below the Speed Limit sign (see Figure 2B-3(VA) in this Supplement).

## Figure 2B-3(VA). Speed Limit and Photo Enforcement Signs and Plaques

(This Figure has been updated for the Virginia Supplement to the MUTCD – Revision 1.)\*



Note: The Traffic Signal – PHOTO ENFORCED sign is shown in Figure 2B-V1 of this Supplement



*Guidance:*

- 10 *A Reduced Speed Limit Ahead (W3-5 or ~~W3-5a~~) sign (see [Section 2C.38 of this Supplement](#)) should be used to inform road users of a reduced speed zone where the speed limit is being reduced by more than 10 mph, or where engineering judgment indicates the need for advance notice to comply with the posted speed limit ahead.*
- 11 *States and local agencies should conduct engineering studies to reevaluate non-statutory speed limits on segments of their roadways that have undergone significant changes since the last review, such as the addition or elimination of parking or driveways, changes in the number of travel lanes, changes in the configuration of bicycle lanes, changes in traffic control signal coordination, or significant changes in traffic volumes.*
- 12 *No more than three speed limits should be displayed on any one Speed Limit sign or assembly.*
- 13 *When a speed limit within a speed zone is posted, it should be within 5 mph of the 85th-percentile speed of free-flowing traffic.*
- 14 *Speed studies for signalized intersection approaches should be taken outside the influence area of the traffic control signal, which is generally considered to be approximately 1/2 mile, to avoid obtaining skewed results for the 85th-percentile speed.*

*Support:*

- 15 *Advance warning signs and other traffic control devices to attract the motorist's attention to a signalized intersection are usually more effective than a reduced speed limit zone.*

*Guidance:*

- 16 *An advisory speed plaque (see [Section 2C.08 of this Supplement](#)) mounted below a warning sign should be used to warn road users of an advisory speed for a roadway condition. A Speed Limit sign should not be used for this situation.*

*Option:*

- 17 *Other factors that may be considered when establishing or reevaluating speed limits are the following:*
  - A. Road characteristics, shoulder condition, grade, alignment, and sight distance;
  - B. The pace;
  - C. Roadside development and environment;
  - D. Parking practices and pedestrian activity; and
  - E. Reported crash experience for at least a 12-month period.
- 18 *Two types of Speed Limit signs may be used: one to designate passenger car speeds, including any nighttime information or minimum speed limit that might apply; and the other to show any special speed limits for trucks and other vehicles.*
- 19 *A changeable message sign that changes the speed limit for traffic and ambient conditions may be installed provided that the appropriate speed limit is displayed at the proper times.*



- 20 A changeable message sign that displays to approaching drivers the speed at which they are traveling may be installed in conjunction with a Speed Limit sign.

*Guidance:*

- 21 *If a changeable message sign displaying approach speeds is installed, the legend YOUR SPEED XX MPH or such similar legend should be displayed. The color of the changeable message legend should be a yellow legend on a black background or the reverse of these colors.*

*Support:*

- 22 Advisory Speed signs and plaques are discussed in [Section 2C.08 of this Supplement and Section 2C.14 of the MUTCD](#). Temporary Traffic Control Zone Speed signs are discussed in the “[Virginia Work Area Protection Manual](#)” (see [Appendix A of this Supplement for link](#)). The WORK ZONE (G20-5aP) plaque intended for installation above a Speed Limit sign is discussed in [Section 6F.14 of the 2011 “Virginia Work Area Protection Manual.”](#) School Speed Limit signs are discussed in [Section 7B.15 of the MUTCD](#). [Photo enforcement signs and plaques are discussed in Section 2B.55 of this Supplement.\\*](#)



## **Section 2B.21 Optional Movement Lane Control Sign (R3-6, R3-V1)**

**Standard:**

- 01 **If used, the Optional Movement Lane Control (R3-6) sign (see [Figure 2B-4\(VA\) in this Supplement](#)) shall be used for two or more movements from a specific lane or to emphasize permitted movements. If used, the Optional Movement Lane Control sign shall be located in advance of the intersection, such as near the upstream end of an adjacent mandatory movement lane, and/or at the intersection where the regulation applies.**
- 02 **If used, the Optional Movement Lane Control sign shall indicate all permissible movements from specific lanes.**
- 03 **Optional Movement Lane Control signs shall be used for two or more movements from a specific lane where a movement, not normally allowed, is permitted.**
- 04 **The Optional Movement Lane Control sign shall not be used alone to effect a turn prohibition.**
- 05 **Where the number of lanes available to through traffic on an approach is three or more, an Optional Movement Lane Control (R3-6) sign, if used, shall be mounted overhead over the specific lane to which it applies (see [Section 2B.19 of the MUTCD](#)).**

*Guidance:*

- 06 *If the Optional Movement Lane Control sign is post-mounted on an approach with two or fewer through lanes, a supplemental plaque (see [Figure 2B-4\(VA\) in this Supplement](#)), such as LEFT LANE (R3-5bP), HOV 2+ (R3-5cP), TAXI LANE (R3-5dP), CENTER LANE (R3-5eP), RIGHT LANE (R3-5fP), or BUS LANE (R3-5gP), should be added above the R3-6 sign to indicate the specific lane from which the optional movements can be made.*

**Option:**

- 07 The word message OK may be used within the border in combination with the arrow symbols of the R3-6 sign.

**Standard:**

- 08 **Because more than one movement is permitted from the lane, the word message ONLY shall not be used on an Optional Movement Lane Control sign.**

**Option:**

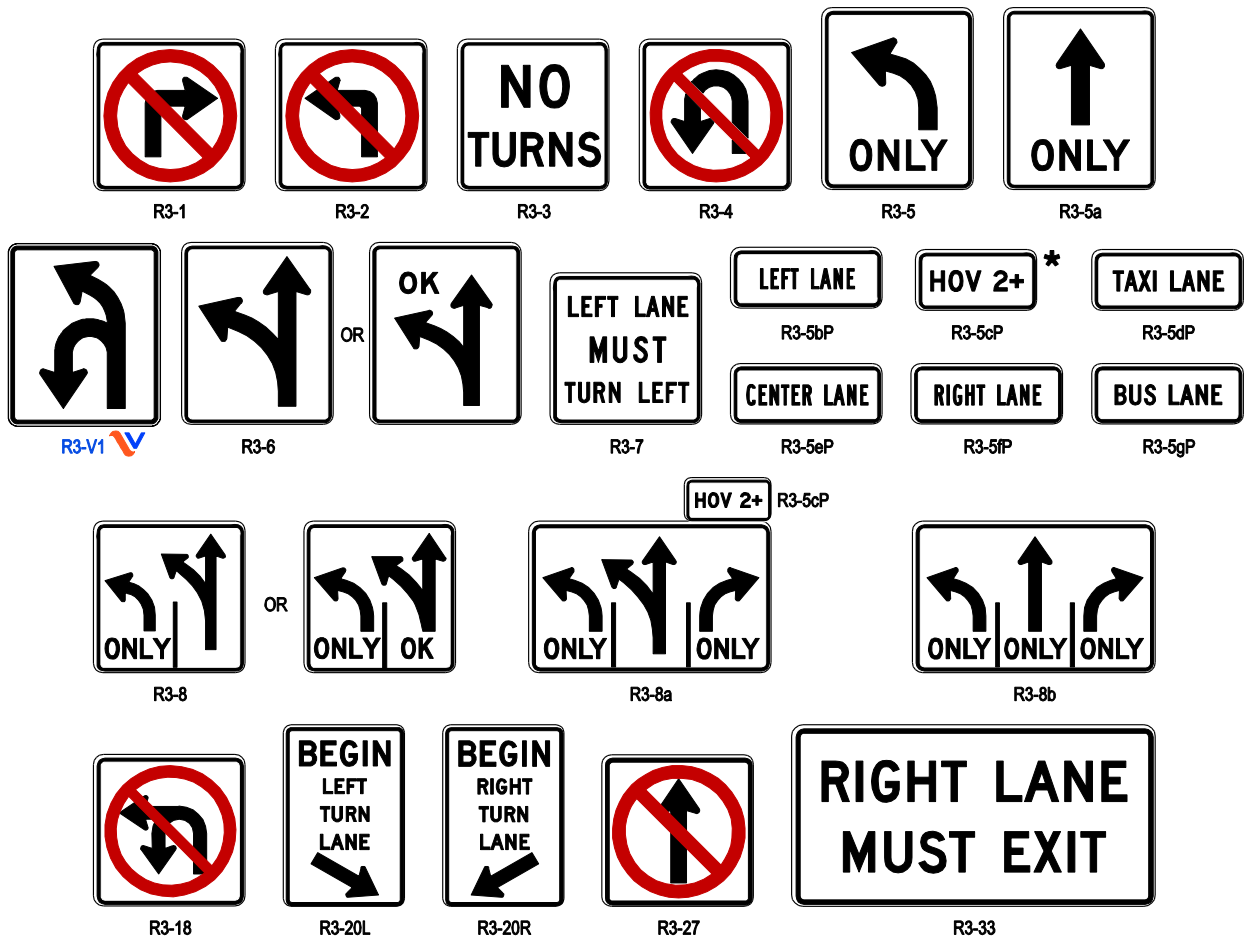
- 09 The Optional U-Turn/Left Turn (R3-V1) sign (see Figure 2B-4(VA) in this Supplement) may be used at signalized intersections where U-turns are allowed from an approach with multiple left-turn lanes.

**Guidance:**

- 10 *R3-V1 signs should be used only at intersections where there are known problems associated with motorists making U-turns from the right-most left turn lane(s).*
- 11 *If used, R3-V1 signs should be mounted overhead and aligned with the center of the lane to which it applies.*



**Figure 2B-4(VA). Movement Prohibition and Lane Control Signs and Plaques**



\* The diamond symbol may be used instead of the "HOV" word message. The minimum vehicle occupancy level may vary, such as 2+, 3+, 4+. The words "LANE" or "ONLY" may be used with this sign when appropriate.



## Section 2B.25 BEGIN and END Plaques (R3-9cP, R3-9cP (V), R3-9dP)



Option:

- 01 The BEGIN (R3-9cP, R3-9cP (V)) or END (R3-9dP) plaques (see Figure 2B-6 in the MUTCD) may be used to supplement a regulatory sign to inform road users of the location where a regulatory condition begins or ends.

Support:

- 02 The use of the BEGIN (R3-9cP (V)) plaque with the HIGHWAY SAFETY CORRIDOR FINES (R0-V5) sign is described in Section 2B.V3 of this Supplement.

Standard:

- 03 If used, the BEGIN or END plaque shall be mounted directly above a regulatory sign.

## Section 2B.39 Selective Exclusion Signs

### Support:

- 01 Selective Exclusion signs (see [Figure 2B-11\(VA\) in this Supplement](#)) give notice to road users that State or local statutes or ordinances exclude designated types of traffic from using particular roadways or facilities.

### Standard:

- 02 **If used, Selective Exclusion signs shall clearly indicate the type of traffic that is excluded.**

### Support:

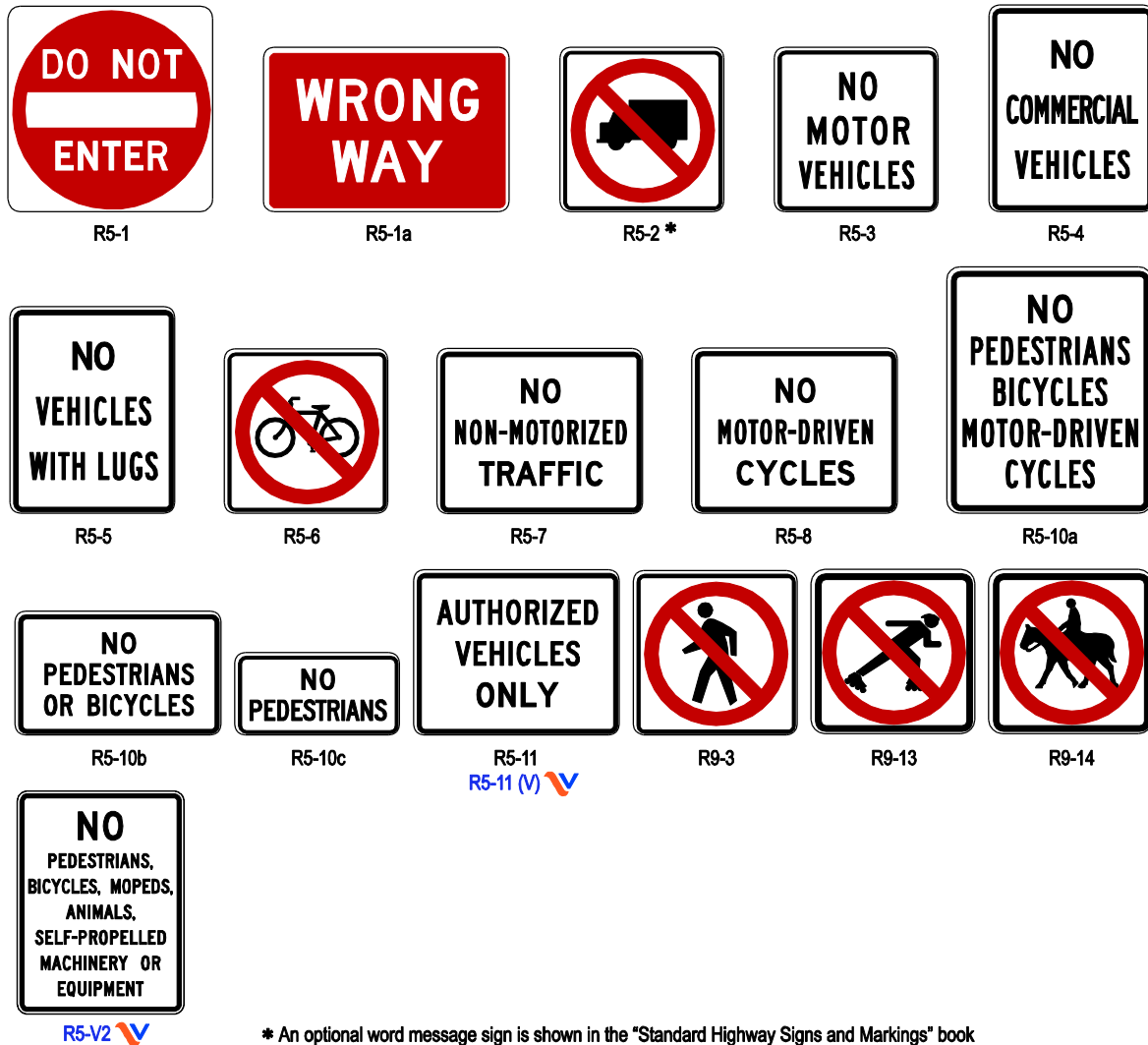
- 03 Typical exclusion messages include:
- A. No Trucks (R5-2),
  - B. NO MOTOR VEHICLES (R5-3),
  - C. NO COMMERCIAL VEHICLES (R5-4),
  - D. NO TRUCKS (VEHICLES) WITH LUGS (R5-5),
  - E. No Bicycles (R5-6),
  - F. NO NON-MOTORIZED TRAFFIC (R5-7),
  - G. NO MOTOR-DRIVEN CYCLES (R5-8),
  - H. No Pedestrians (R9-3),
  - I. No Skaters (R9-13),
  - J. No Equestrians (R9-14), and
  - K. No Hazardous Material (R14-3) (see [Section 2B.62 of the MUTCD](#)).

### Option:

- 04 Appropriate combinations or groupings of these legends into a single sign, such as NO PEDESTRIANS BICYCLES MOTOR-DRIVEN CYCLES (R5-10a), or NO PEDESTRIANS OR BICYCLES (R5-10b) may be used.

### Guidance:

- 05 *If an exclusion is governed by vehicle weight, a Weight Limit sign (see [Section 2B.59 of this Supplement](#)) should be used instead of a Selective Exclusion sign.*
- 06 *If used on a freeway or expressway ramp, the NO PEDESTRIANS OR BICYCLES (R5-10b) sign should be installed in a location where it is clearly visible to any pedestrian or bicyclist attempting to enter the limited access facility from a street intersecting the exit ramp.*
- 07 *The Selective Exclusion sign should be placed on the right-hand side of the roadway at an appropriate distance from the intersection so as to be clearly visible to all road users turning into the roadway that has the exclusion. The NO PEDESTRIANS (R5-10c) or No Pedestrian Crossing (R9-3) sign (see [Section 2B.51 of the MUTCD](#)) should be installed so as to be clearly visible to pedestrians who are at a location where an alternative route is available.*

**Figure 2B-11(VA). Selective Exclusion Signs****Option:**

- 08 The NO PEDESTRIANS (R5-10c) or No Pedestrian Crossing (R9-3) sign may also be used at underpasses or elsewhere where pedestrian facilities are not provided.
- 09 The NO TRUCKS (R5-2a) word message sign may be used as an alternate to the No Trucks (R5-2) symbol sign.

**Standard:**

- 10 **The AUTHORIZED VEHICLES ONLY (R5-11 (V)) sign shall be installed on limited access highways at all non-chained crossovers not intended for public use, to prohibit vehicles from using the median opening or facility unless they have special permission (such as law enforcement vehicles or emergency vehicles) or are performing official highway business authorized by VDOT.**



*Guidance:*

- 11 *The AUTHORIZED VEHICLES ONLY (R5-11 (V)) sign should be installed at non-chained crossovers not intended for public use when it has been determined that motorists frequently attempt to use the crossover.*

## Support:

- 12 The AUTHORIZED VEHICLES ONLY (R5-11 (V)) sign for non-chained crossovers is used in accordance with The Code of Virginia § 46.2-808.1.

## Option:

- 13 The AUTHORIZED VEHICLES ONLY (R5-11 (V)) sign may also be installed at maintenance driveways along limited access highways.

**Standard:**

- 14 **The NO PEDESTRIANS, BICYCLES, MOPEDS, ANIMALS, SELF-PROPELLED MACHINERY, OR EQUIPMENT (R5-V2) sign shall be used to mark the entrances to any section of limited access highway on which the Commonwealth Transportation Board has imposed such restriction.**

## Support:

- 15 An entrance to a section of limited access highway can include locations where a non-limited access facility turns into a limited access facility.
- 16 The NO PEDESTRIANS, BICYCLES, MOPEDS, ANIMALS, SELF-PROPELLED MACHINERY, OR EQUIPMENT (R5-V2) sign is required in accordance with the Code of Virginia § 46.2-808.

## **Section 2B.41 Wrong-Way Traffic Control at Interchange**

### **Ramps**

**Standard:**

- 01 **At interchange exit ramp terminals where the ramp intersects a crossroad in such a manner that wrong-way entry could inadvertently be made, the following signs shall be used (see Figure 2B-18(VA) in this Supplement):**
- A. Two ONE WAY signs for each direction of travel on the crossroad shall be placed where the exit ramp intersects the crossroad.**
  - B. If an island exists on the ramp between the channelized right turn lane and the stop controlled lane(s), two ONE WAY signs for each direction of travel on the crossroad shall be placed in the island.**
  - C. At least two DO NOT ENTER signs shall be conspicuously placed near the downstream end of the exit ramp in positions appropriate for full view of a road user starting to enter wrongly from the crossroad.**
  - D. One DO NOT ENTER sign shall be conspicuously placed on the back of the STOP or YIELD sign controlling movements on the channelized right turn lane. See Section 2B.10 of the MUTCD for guidance related to signs mounted on the back of STOP or YIELD signs.**



- E. **Two WRONG WAY signs shall be placed on the exit ramp at least 250 feet from the crossroad facing a road user traveling in the wrong direction.**
  - F. **A NO LEFT TURN and/or a NO RIGHT TURN sign shall be placed on the crossroad in advance of the intersection with the ramp.**
- 02 **At interchange exit ramp terminals where the ramp intersects a crossroad in such a manner that wrong-way entry could inadvertently be made, the following pavement markings shall be used (see Figure 2B-18(VA) in this Supplement):**
- ~~A. On two-lane paved crossroads at interchanges, double solid yellow lines shall be used as a center line for an adequate distance on both sides approaching the ramp intersections.\*~~
  - B.A. A lane-use arrow shall be placed in each lane of an exit ramp near the crossroad terminal where it will be clearly visible to a potential wrong-way road user and to indicate the permissive direction of flow.**
  - ~~C.B.~~ **Slender, elongated wrong-way arrow pavement markings (see Figure 3B-24) intended primarily to warn wrong-way road users that they are traveling in the wrong direction shall be placed upstream from the ramp terminus (see Figure 2B-18(VA) in this Supplement) to indicate the correct direction of traffic flow.**
  - ~~D.C.~~ **When channelized turn roadways exist, a wrong-way arrow shall be placed near the channelized turn roadway terminal.**

*Guidance:*

- 03 *On two-lane paved crossroads at interchanges, double solid yellow lines should be used as a center line on both sides approaching the ramp intersections.\**

Option:

- 0304 The following traffic control devices may be used to supplement the signs and pavement markings described in Paragraphs 1 and 2:
- A. Additional ONE WAY signs may be placed, especially on two-lane rural crossroads, appropriately in advance of the ramp intersection to supplement the required ONE WAY sign(s).
  - B. Additional WRONG WAY signs may be used.
  - C. Additional wrong-way arrow pavement markings may also be placed on the exit ramp at appropriate locations to indicate wrong-way movement.
  - D. The additional wrong-way arrow markings may consist of pavement markings or a combination of pavement markings and bidirectional red-and-white raised pavement markers or other units that show red to wrong-way road users and white to other road users (see Figure 3B-24).
  - E. Lane-use arrow pavement markings may be placed on the crossroad near its intersection with the exit ramp to indicate the permissive direction of flow.
  - F. Freeway entrance signs (see Section 2D.46 of the MUTCD) may be used.

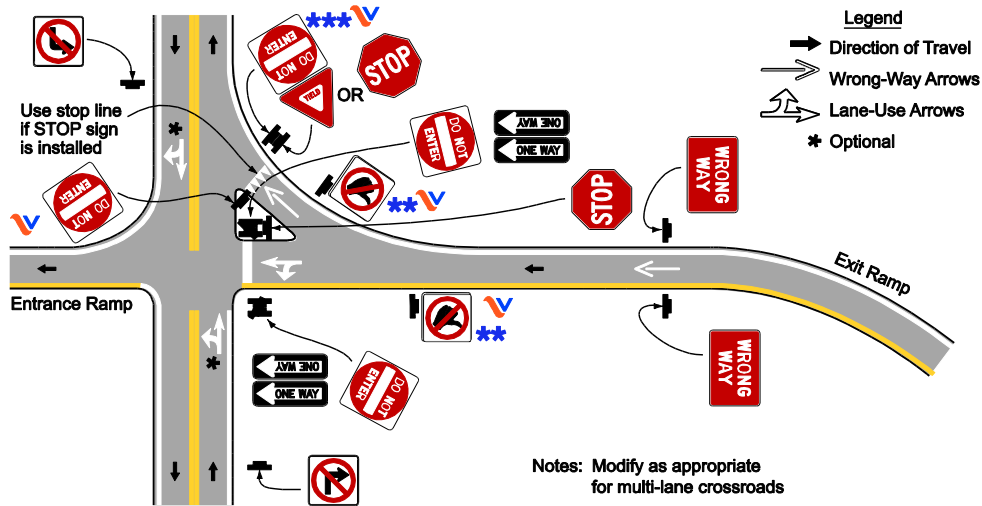


**Standard:**

0405 If bidirectional red-and-white raised pavement markers are used according to the option in Section D of Paragraph 4, an engineering study shall be conducted to justify the use of the markers.

**Figure 2B-18(VA). Example of Application of Regulatory Signing and Pavement Markings at an Exit Ramp Termination to Deter Wrong-Way Entry**

(This Figure has been updated for the Virginia Supplement to the MUTCD – Revision 1.)\*



\*\* The No Hitchhiking signs are shown for informational purposes (see Section 2B.50 of this Supplement for use of the sign) V

\*\*\* Signs mounted on the back of STOP or YIELD signs should not obscure the shape of the STOP or YIELD sign. V  
See MUTCD Section 2B.10 for guidance related to signs mounted on the back of STOP or YIELD signs.

**Standard:** Guidance: (The following paragraph has reverted from a Standard to Guidance, as it appears in the 2009 MUTCD. The actual text remains the same except for the word "should.")\*

0506 On interchange entrance ramps where the ramp merges with the through roadway and the design of the interchange does not clearly make evident the direction of traffic on the separate roadways or ramps, a ONE WAY sign visible to traffic on the entrance ramp and through roadway shall should\* be placed on each side of the through roadway near the entrance ramp merging point as illustrated in Figure 2B-19.

**Option:**

0607 At locations where engineering judgment determines that a special need exists, other standard warning or prohibitive methods and devices may be used as a deterrent to the wrong-way movement.

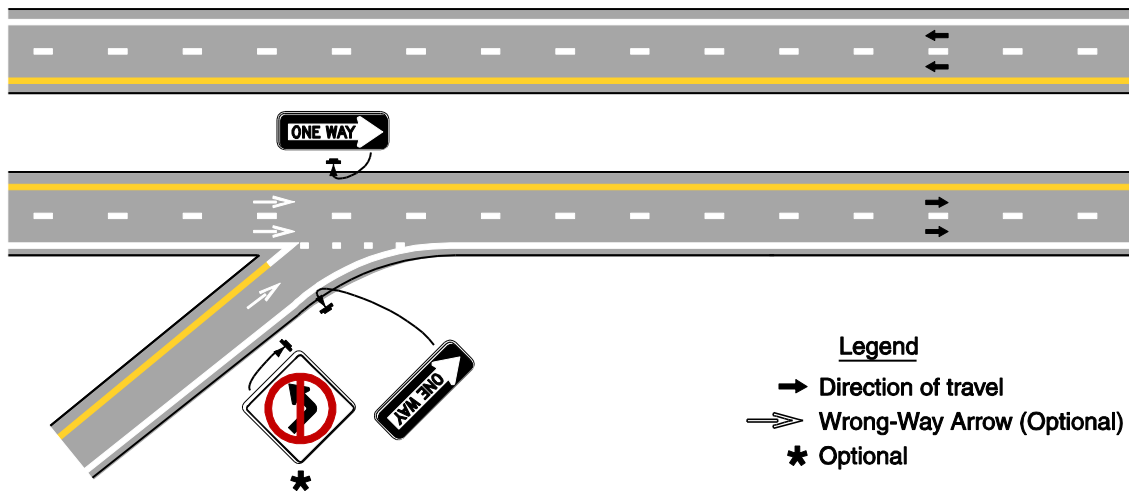


**Standard:**

**0708** Except for where DO NOT ENTER signs are attached to the back of a STOP or YIELD sign, ONE WAY signs shall be mounted below the DO NOT ENTER signs. See Section 2B.10 of the MUTCD for guidance related to signs mounted on the back of STOP or YIELD signs.

**0809** DO NOT ENTER & ONE WAY sign assemblies (see Figure 2B-18(VA) in this Supplement) that are located along the exit ramp facing a road user who is traveling in the wrong direction shall be installed at a minimum mounting height of 3 feet, measured vertically from the bottom of the ONE WAY sign to the elevation of the near edge of the pavement.

**Figure 2B-19. Example of Application of Regulatory Signing and Pavement Markings at an Entrance Terminal Where the Design Does Not Clearly Indicate the Direction of Flow**

**Support:**

**0910** Section 2B.42 of the MUTCD contains further information on signing to avoid wrong-way movements at at-grade intersections on expressways.

## **Section 2B.46 Parking, Standing, and Stopping Signs (R7 and R8 Series)**

**Support:**

- 01 Signs governing the parking, stopping, and standing of vehicles cover a wide variety of regulations, and only general guidance can be provided here. The word "standing" when used on the R7 and R8 series of signs refers to the practice of a driver keeping the vehicle in a stationary position while continuing to occupy the vehicle. Typical examples

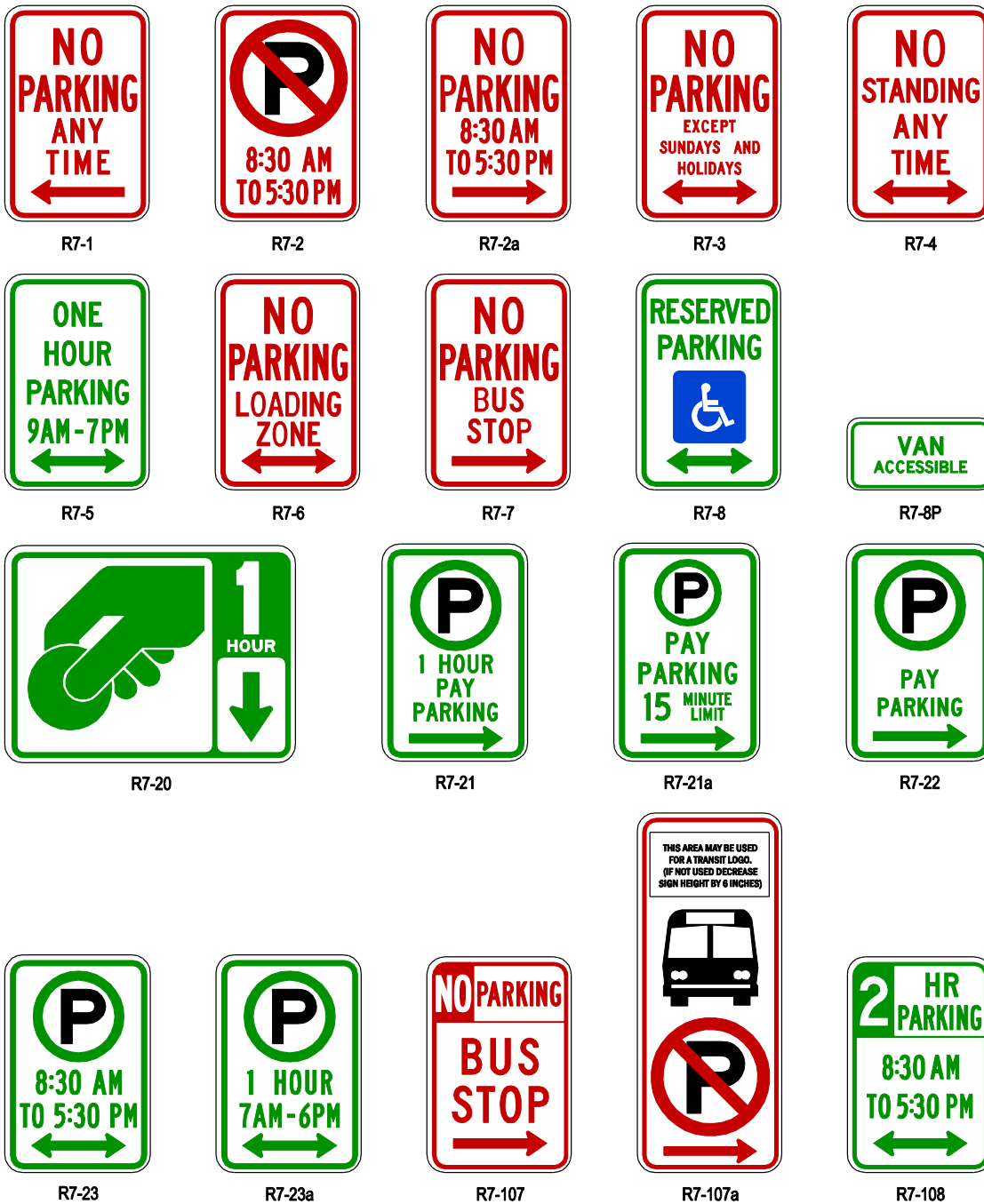
of parking, stopping, and standing signs and plaques (see [Figures 2B-24\(VA\) and 2B-25\(VA\) in this Supplement](#)) are as follows:

1. NO PARKING ANY TIME (R7-1);
2. NO PARKING X:XX AM TO X:XX PM (R7-2, R7-2a);
3. NO PARKING EXCEPT SUNDAYS AND HOLIDAYS (R7-3);
4. NO STANDING ANY TIME (R7-4);
5. XX HOUR PARKING X:XX AM – X:XX PM (R7-5);
6. NO PARKING LOADING ZONE (R7-6);
7. NO PARKING BUS STOP (R7-7, R7-107, R7-107a);
8. RESERVED PARKING for persons with disabilities (R7-8);
9. VAN ACCESSIBLE (R7-8P);
10. Pay Station (R7-20);
11. Pay Parking (R7-21, R7-21a, R7-22);
12. Parking Permitted X:XX AM TO X:XX PM (R7-23);
13. Parking Permitted XX HOUR(S) XX AM – XX PM (R7-23a);
14. XX HR PARKING X:XX AM TO X:XX PM (R7-108);
15. NO PARKING ANYTIME/XX HOUR PARKING X:XX AM – X:XX PM (R7-200, R7-200a);
16. TOW-AWAY ZONE (R7-201P, R7-201aP);
17. THIS SIDE OF SIGN (R7-202P);
18. EMERGENCY SNOW ROUTE NO PARKING IF OVER XX INCHES (R7-203);
19. NO PARKING ON PAVEMENT (R8-1);
20. NO PARKING EXCEPT ON SHOULDER (R8-2);
21. No Parking (R8-3, R8-3a);
22. EXCEPT SUNDAYS & HOLIDAYS (R8-3bP);
23. ON PAVEMENT (R8-3cP);
24. ON BRIDGE (R8-3dP);
25. ON TRACKS (R8-3eP);
26. EXCEPT ON SHOULDER (R8-3fP);
27. LOADING ZONE (R8-3gP);
28. X:XX AM TO X:XX PM (R8-3hP);
29. EMERGENCY PARKING ONLY (R8-4);
30. NO STOPPING ON PAVEMENT (R8-5);
31. NO STOPPING EXCEPT ON SHOULDER (R8-6);
32. EMERGENCY STOPPING ONLY (R8-7);
33. TOW-AWAY ZONE PENALTY \$100-\$500 FINE Plaque (R7-VP1);
34. STATE POLICE PARKING ONLY (R7-V1).



02 For additional information related to the modification of parking, standing, and stopping signs to describe the applicable regulations, see Section 2A.06 of this Supplement and Section 2B.47 of the MUTCD.\*

**Figure 2B-24(VA). Parking and Standing Signs and Plaques (R7 Series) (Sheet 1 of 2)**

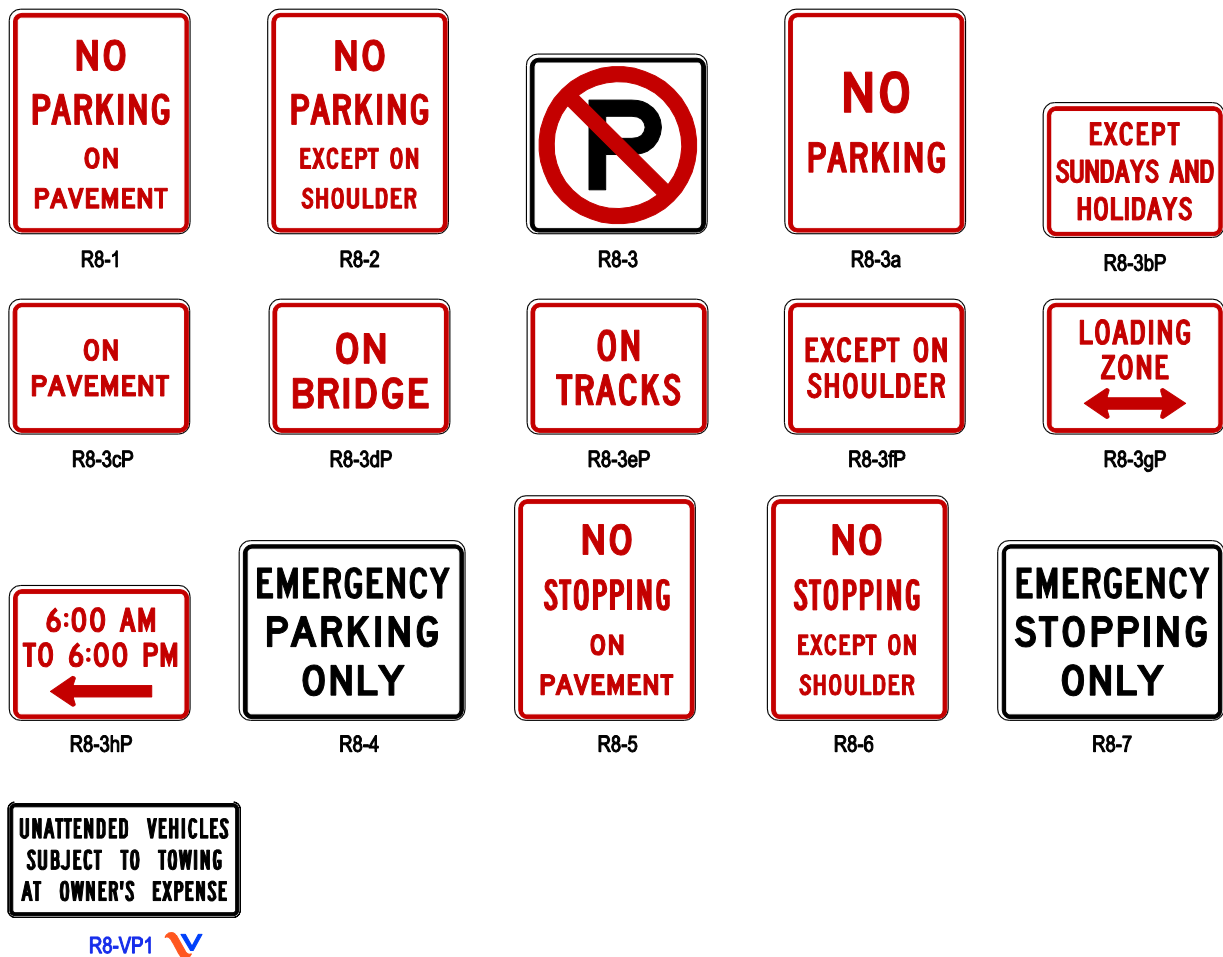


\*Revised 9/30/2013

**Figure 2B-24(VA). Parking and Standing Signs and Plaques  
(R7 Series) (Sheet 2 of 2)**



**Figure 2B-25(VA). Parking and Stopping Signs and Plaques (R8 Series)**



## **Section 2B.49 Emergency Restriction Signs (R8-4, R8-7, R8-8, R8-VP1)**

Option:

- 01 The EMERGENCY PARKING ONLY (R8-4) sign or the EMERGENCY STOPPING ONLY (R8-7) sign (see [Figure 2B-25\(VA\)](#) in this Supplement) may be used to discourage or prohibit shoulder parking, particularly where scenic or other attractions create a tendency for road users to stop temporarily.
- 02 The DO NOT STOP ON TRACKS (R8-8) sign (see [Figure 8B-1](#) in the MUTCD) may be used to discourage or prohibit parking or stopping on railroad or light rail transit tracks (see [Section 8B.09](#) of the MUTCD).

**Standard:**

- 03 **Emergency Restriction signs shall be rectangular and shall have a red or black legend and border on a white background.**

**Option:**

- 04 At the request of the Virginia State Police, an UNATTENDED VEHICLES SUBJECT TO TOWING AT OWNERS EXPENSE (R8-VP1) plaque may be added to the EMERGENCY STOPPING ONLY (R8-7) sign (see Figure 2B-25(VA) in this Supplement).



## **Section 2B.50 WALK ON LEFT FACING TRAFFIC and No Hitchhiking Signs (R9-1, R9-4, R9-4a)**

**Option:**

- 01 The WALK ON LEFT FACING TRAFFIC (R9-1) sign (see Figure 2B-26) may be used on highways where no sidewalks are provided.

**Standard:**

- 02 **If used, the WALK ON LEFT FACING TRAFFIC sign shall be installed on the right-hand side of the road where pedestrians walk on the pavement or shoulder in the absence of pedestrian pathways or sidewalks.**

**Option:**

- 03 The No Hitchhiking (R9-4) sign (see Figure 2B-26) may be used to prohibit standing in or adjacent to the roadway for the purpose of soliciting a ride. The R9-4a word message sign (see Figure 2B-26) may be used as an alternate to the R9-4 symbol sign. Typical placement of the No Hitchhiking (R9-4) sign on a freeway interchange ramp is shown in Figure 2B-18(VA) in this Supplement.

**Standard:**

- 04 **When used on a freeway interchange ramp, the No Hitchhiking (R9-4) sign shall be placed no less than 50 feet and no greater than 100 feet from the stop line pavement marking.**

## **Section 2B.53 Traffic Signal Signs (R10-5 through R10-30)**

**Option:**

- 01 To supplement traffic signal control, Traffic Signal signs R10-5 through R10-30 may be used to regulate road users.



- 02 Traffic Signal signs (see Figure 2B-27(VA) in this Supplement) may be installed at certain locations to clarify signal control. Among the legends that may be used for this purpose are LEFT ON GREEN ARROW ONLY (R10-5), STOP HERE ON RED (R10-6 or R10-6a) for observance of stop lines, DO NOT BLOCK INTERSECTION (R10-7) for avoidance of traffic obstructions, USE LANE(S) WITH GREEN ARROW (R10-8) for obedience to lane-use control signals (see Chapter 4M), LEFT TURN YIELD ON GREEN (symbolic circular green)

(R10-12), **LEFT TURN YIELD ON FLASHING YELLOW ARROW (R10-V1)\***, and LEFT TURN YIELD ON FLASHING RED ARROW AFTER STOP (R10-27).

*Guidance:*

- 03 If used, the LEFT ON GREEN ARROW ONLY (R10-5) sign, the LEFT TURN YIELD ON GREEN (symbolic circular green) (R10-12) sign, **the LEFT TURN YIELD ON FLASHING YELLOW ARROW (R10-V1) sign,\*** or the LEFT TURN YIELD ON FLASHING RED ARROW AFTER STOP (R10-27) sign should be located adjacent to the left-turn signal face.

*Option:*

- 04 If needed for additional emphasis, an additional LEFT TURN YIELD ON GREEN (symbolic circular green) (R10-12) sign **or LEFT TURN YIELD ON FLASHING YELLOW ARROW (R10-V1) sign\*** with an AT SIGNAL (R10-31P) supplemental plaque (see [Figure 2B-27\(VA\) in this Supplement](#)) may be installed in advance of the intersection.
- 05 In situations where traffic control signals are coordinated for progressive timing, the Traffic Signal Speed (I1-1) sign may be used (see [Section 2H.03 of the MUTCD](#)).

**Standard:**

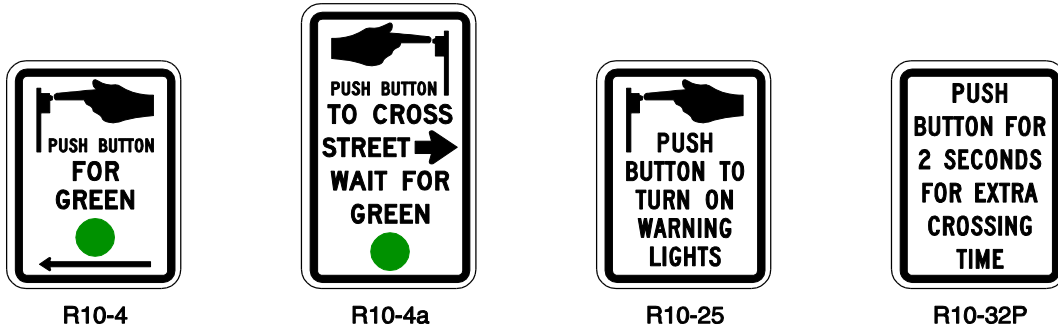
- 06 **The CROSSWALK STOP ON RED (symbolic circular red) (R10-23) sign (see [Figure 2B-27\(VA\) in this Supplement](#)) shall only be used in conjunction with pedestrian hybrid beacons (see [Section 4F.02 of the MUTCD](#)).**
- 07 **The EMERGENCY SIGNAL (R10-13) sign (see [Figure 2B-27\(VA\) in this Supplement](#)) shall be used in conjunction with emergency-vehicle traffic control signals (see [Section 4G.02 of the MUTCD](#)).**
- 08 **The EMERGENCY SIGNAL—STOP ON FLASHING RED (R10-14 or R10-14a) sign (see [Figure 2B-27\(VA\) in this Supplement](#)) shall be used in conjunction with emergency-vehicle hybrid beacons (see [Section 4G.04 of the MUTCD](#)).**

Figure 2B-26. Pedestrian Signs and Plaques (Sheet 1 of 2)





## Figure 2B-26. Pedestrian Signs and Plaques (Sheet 2 of 2)



Option:

- 09 In order to remind drivers who are making turns to yield to pedestrians, a Turning Vehicles Yield to Pedestrians (R10-15) sign (see [Figure 2B-27\(VA\) in this Supplement](#)) may be used.

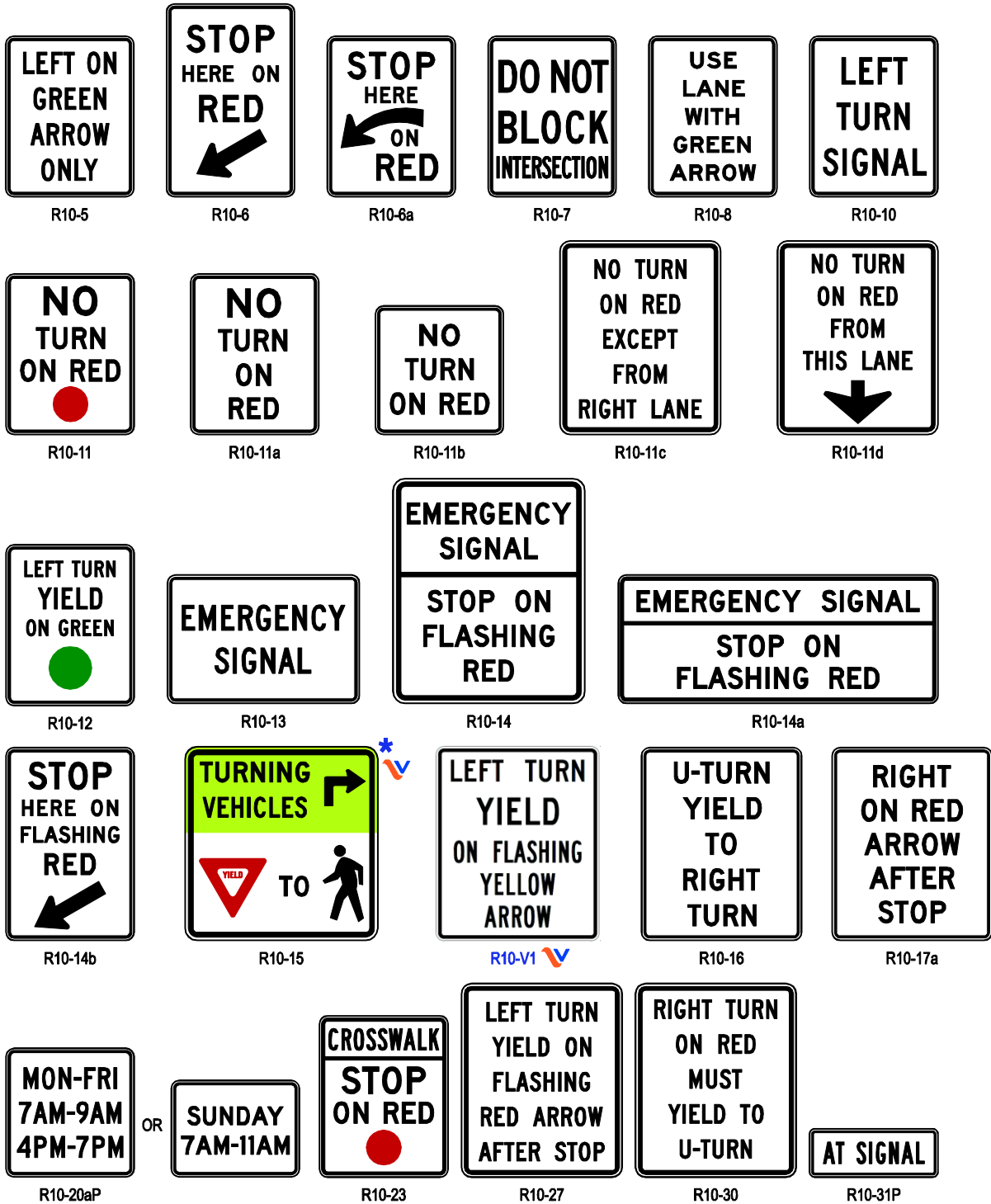
**Standard:**

- 10 **If used, the TURNING VEHICLES YIELD TO PEDESTRIANS (R10-15) sign shall utilize a fluorescent yellow-green background (see [Figure 2B-27\(VA\) in this Supplement](#)).**
- 11 **A U-TURN YIELD TO RIGHT TURN (R10-16) sign (see [Figure 2B-27\(VA\) in this Supplement](#)) may be installed near the left-turn signal face if U-turns are allowed on a protected left-turn movement on an approach from which a right-turn GREEN ARROW signal indication is simultaneously being displayed to drivers making a right turn from the conflicting approach to their left.**



### Figure 2B-27(VA). Traffic Signal Signs and Plaques

(This Figure has been updated for the Virginia Supplement to the MUTCD – Revision 1.)\*



\* A fluorescent yellow-green background color may shall be used instead of yellow for this sign.



## Section 2B.55 Photo Enforced Signs and Plaques (R10-18, R10-19P, R10-19aP, R10-18a) (This Section has been added to the Virginia Supplement to the MUTCD - Revision 1.)\*

### Option:

- 01 A TRAFFIC LAWS PHOTO ENFORCED (R10-18) sign (see [Figure 2B-3\(VA\) in this Supplement](#)) may be installed at a jurisdictional boundary to advise road users that some of the traffic regulations within that jurisdiction are being enforced by photographic equipment.\*
- 02 A PHOTO ENFORCED (R10-19P) plaque or a PHOTO ENFORCED (R10-19aP) word message plaque (see [Figure 2B-3\(VA\) in this Supplement](#)) may be mounted below a regulatory sign to advise road users that the regulation is being enforced by photographic equipment.\*

### Standard:

- 03 If used below a regulatory sign, the Photo Enforced (R10-19P or R10-19aP) plaque shall be a rectangle with a black background.\*

### Option:

- 04 A Traffic Signal – PHOTO ENFORCED (R10-18a) sign (see [Figure 2B-V1](#)) may be installed in advance of a traffic signal where red-light cameras are present on any approach to the signalized intersection.\*

### Standard:

- 05 The Traffic Signal – PHOTO ENFORCED (R10-18a) sign shall not be installed on approaches to signalized intersections where red-light cameras are not present on any of the approaches to the signalized intersection.\*
- 06 If used, the Traffic Signal – PHOTO ENFORCED (R10-18a) sign shall be individually installed on a separate post or mounting. A Traffic Signal – PHOTO ENFORCED (R10-18a) sign shall not be installed on the same support in combination with a Signal Ahead (W3-3) sign. A Signal Ahead (W3-3) sign and a Traffic Signal – PHOTO ENFORCED (R10-18a) sign are permitted on the same approach, however they shall be installed on separate sign structures.\*

### Guidance:

- 07 If used, the Traffic Signal – PHOTO ENFORCED (R10-18a) sign should be located on the right-hand side of the roadway far enough in advance of the stop line to provide adequate notice to approaching road users.\*

### Option:

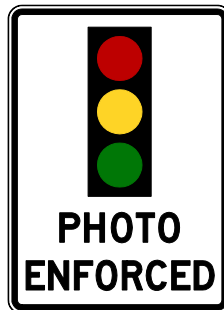
- 08 On one-way streets, or where a median of sufficient width is present, an additional Traffic Signal – PHOTO ENFORCED (R10-18a) sign may be placed on the left-hand side of the roadway in accordance with Paragraph 11 of Section 2A.16 of the MUTCD.\*





## **Figure 2B-V1. Traffic Signal – PHOTO ENFORCED Sign**

(This Figure has been updated for the Virginia Supplement to the MUTCD - Revision 1.)\*



R10-18a



## **Section 2B.59 Weight Limit Signs (R12-1 through R12-4, R12-5, R12-V1, R12-VP1)**

### Option:

- 01 The Weight Limit (R12-1) sign carrying the legend WEIGHT LIMIT XX TONS may be used to indicate vehicle weight restrictions including load.
- 02 Where the restriction applies to axle weight rather than gross load, the legend may be AXLE WEIGHT LIMIT XX TONS or AXLE WEIGHT LIMIT XX LBS (R12-2).
- 03 To restrict trucks of certain sizes by reference to empty weight in residential areas, the legend may be NO TRUCKS OVER XX TONS EMPTY WT or NO TRUCKS OVER XX LBS EMPTY WT (R12-3).
- 04 In areas where multiple regulations of the type described in Paragraphs 1 through 3 are applicable, a sign combining the necessary messages on a single sign may be used, such as WEIGHT LIMIT XX TONS PER AXLE, XX TONS GROSS (R12-4).

### Support:

- 05 The Code of Virginia § 46.2-1130 prohibits vehicles from crossing any bridge or culvert if the gross weight of such vehicle is greater than the amount posted for the bridge or culvert as its carrying capacity.

### Standard:

- 06 In accordance with the Code of Virginia, Weight Limit symbol (R12-V1) signs (see Figure 2B-29(VA) in this Supplement) shall be installed near each end of bridges and culverts as described in Paragraph 5. Additionally, Weight Limit symbol signs shall be installed in advance of the last alternate route approaching the bridge. At the nearest junction upstream of the bridge, the R12-V1 sign shall also be installed in both directions of the cross streets so as to prevent turning traffic from approaching the bridge. Figure ~~2B-V1~~ 2B-V2\* in this Supplement shows an example of such signing.



07 **The R12-5 Weight Limit sign from the MUTCD shall not be used.**

*Guidance:*

08 *If the weight restriction for a single unit truck is over 20 tons, the truck symbol should show tandem axles on the rear. If the weight restriction for a tractor-trailer combination is over 30 tons, the trailer symbol should show tandem axles.*

09 *Table 2C-4 should be used to determine the placement distance of the signs in advance of the last alternate route. One additional Weight Limit symbol (R12-V1) sign should be installed a maximum of 150 feet beyond the last intersection on the approach road in advance of the bridge or culvert.*

*Option:*

10 An advisory distance ahead plaque (see Section 2C.53 of the MUTCD) may be placed in advance of the last alternate route intersection.

**Standard:**

11 **Where a Weight Limit symbol (R12-V1) sign is installed because of a weight restriction on a bridge, the BRIDGE (R12-VP1) plaque shall be mounted above.**

12 **When the advance signs are installed on the approach roads, a third sign consisting of the appropriate Directional Arrow Auxiliary (M6 Series) sign (see Section 2D.28 of the MUTCD) shall be included below the Weight Limit symbol sign to indicate the direction of the structure shall be installed (see Figure 2B-29(VA) in this Supplement).**

*Option:*

13 Restricted structures on secondary routes may be signed using the R12-1 sign if engineering judgment determines that significant volumes of trucks carrying semi-trailers are not present.

*Guidance:*

14 *When using the Option described in Paragraph 13 above, advance signing should consist of the same signing as required in Paragraphs 6 through 12 above, with the R12-1 sign substituting for the R12-V1 sign.*

*Support:*

15 The R12-V1 sign design is variable based on the weight restrictions determined for the truck classifications. Refer to the “Virginia Standard Highway Signs” book (see Appendix A of this Supplement for link) for design details.

Figure 2B-29(VA). Road Closed and Weight Limit Signs

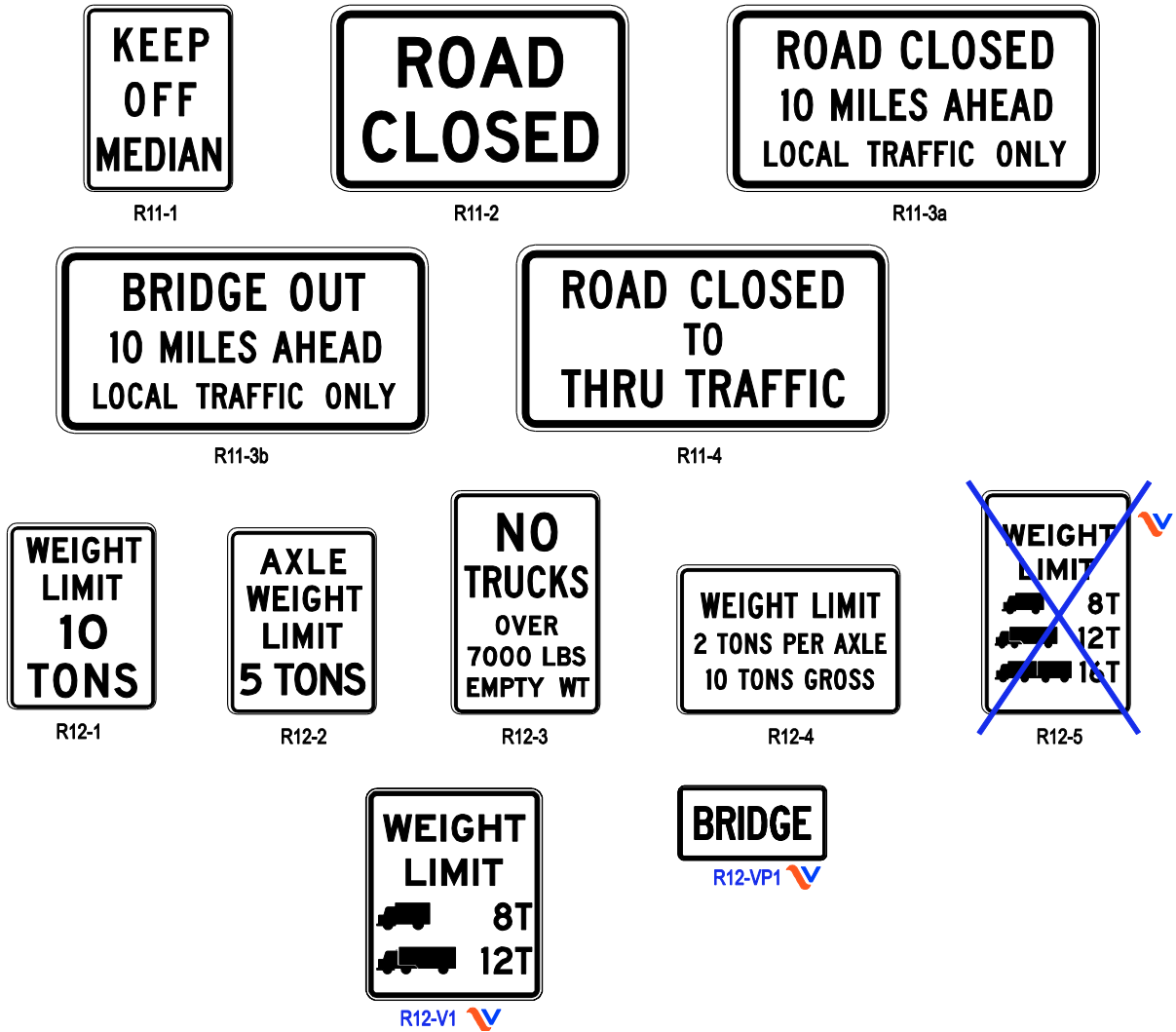
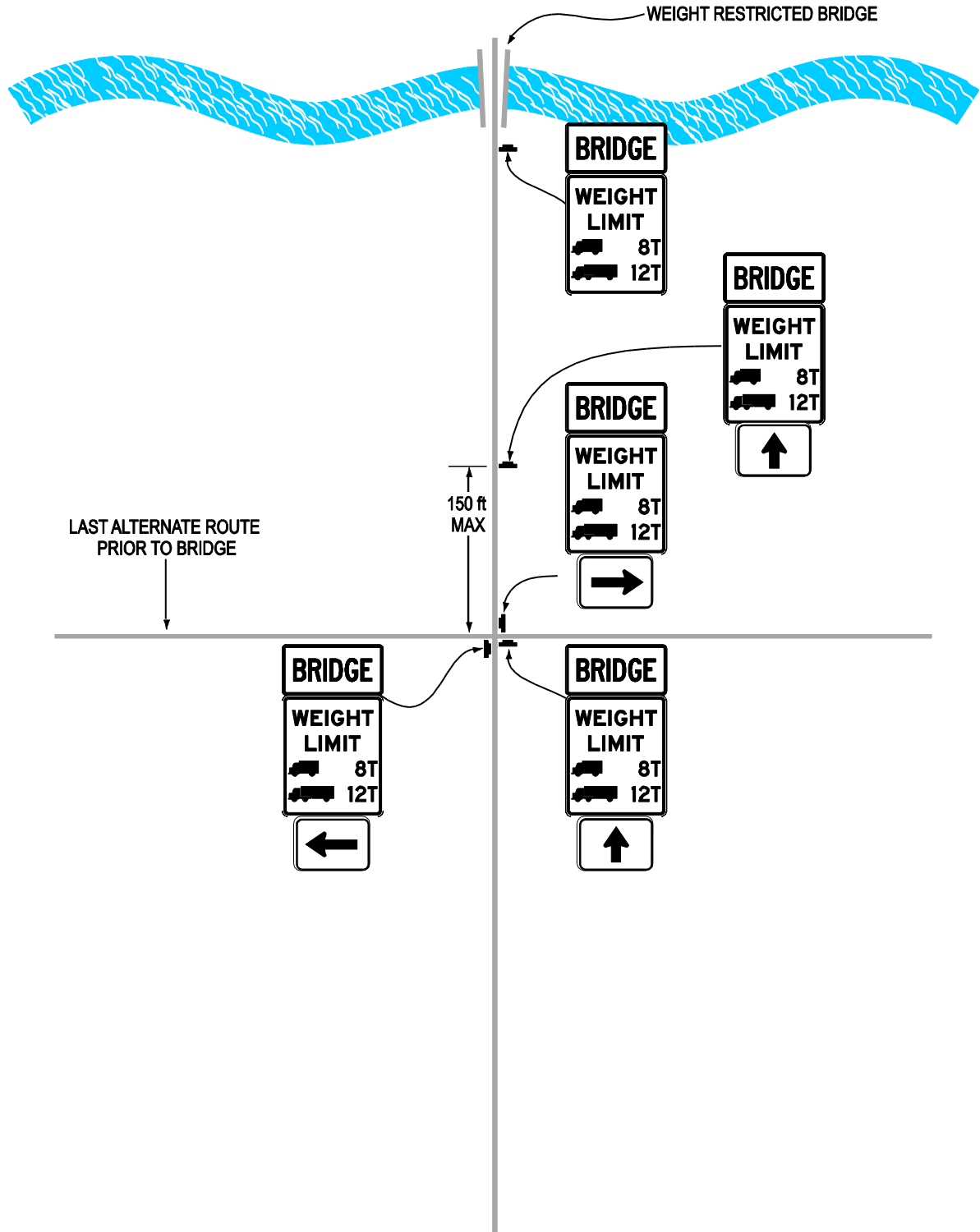




Figure 2B-V1 V2. Example of \*Bridge Weight Limit Signage\*  
Signage\*



\*Revised 9/30/2013

## Section 2B.64 Headlight Use Signs (R16-5 through R16-11)

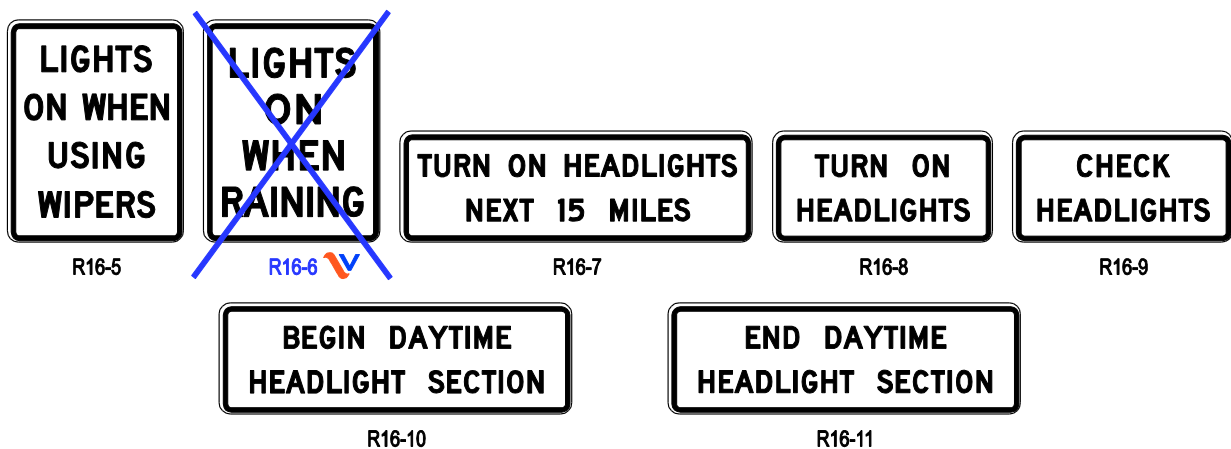
Support:

- 01 Virginia requires road users to turn on their vehicle headlights under certain weather conditions, as a safety improvement measure on roadways experiencing high crash rates, or in special situations such as when driving through a tunnel.
- 02 Figure 2B-31(VA) in this Supplement shows the various signs that can be used for informing motorists of these requirements.

Standard:

- 03 LIGHTS ON WHEN USING WIPERS (R16-5) signs shall be installed on Interstates and other major routes at or near the State boundary facing traffic entering Virginia.
- 04 The LIGHTS ON WHEN RAINING (R16-6) sign shall not be used in Virginia.

Figure 2B-31(VA). Headlight Use Signs



Support:

- 05 In accordance with the Code of Virginia § 46.2-1030, drivers are required to turn on vehicle headlights when using wipers. The Code of Virginia does not require drivers to turn on vehicle headlights when raining if wipers are not being used; therefore the R16-6 sign is not used in Virginia.

Option:

- 06 These signs may also be installed at other locations within the State where engineering judgment determines they are necessary.

Guidance:

- 07 If a particular section of roadway has been designated as a safety improvement zone within which headlight use is required, a TURN ON HEADLIGHTS NEXT XX MILES (R16-7) sign or a BEGIN DAYTIME HEADLIGHT SECTION (R16-10) sign should be installed at the upstream end of the section, and a END DAYTIME HEADLIGHT SECTION (R16-11) sign should be installed at the downstream end of the section.



Option:

- 08 A TURN ON HEADLIGHTS (R16-8) sign may be installed to require road users to turn on their headlights in special situations such as when driving through a tunnel. A CHECK HEADLIGHTS (R16-9) sign may be installed downstream from the special situation to inform drivers that the using their headlights is no longer required.

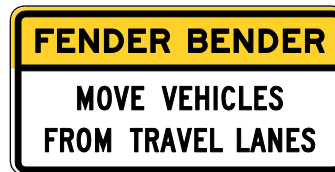



## Section 2B.65 **FENDER BENDER Sign (R16-4, R16-4 (V))**

Option:

- 01 A FENDER BENDER MOVE VEHICLES FROM TRAVEL LANES (R16-4, R16-4 (V)) sign (see [Figure 2B-32\(VA\) in this Supplement](#)) may be installed to require motorists to move their vehicle out of the travel lanes if they have been involved in a crash.

### Figure 2B-32(VA). Other Regulatory Signs and Symbols



R16-4  
R16-4 (V) 



Seat Belt Symbol

*Guidance:*

- 02 *The R16-4 or R16-4(V) sign should be placed at locations with major highway construction, and at locations where traffic congestion is known to occur.*

*Support:*

- 03 For more information on the use of the R16-4 or R16-4(V) sign for temporary traffic control applications, see Section 6F.17 of the "Virginia Work Area Protection Manual" (link provided in Appendix A).\*

- 0304 The sign placement guidelines described in Paragraph 02 are in accordance with Virginia\* 1999 House Joint Resolution 570.



*Guidance:*

0405 A CALL CELLULAR #77 FOR STATE POLICE (D12-V1) sign should be installed below a FENDER BENDER MOVE VEHICLES FROM TRAVEL LANES (R16-4, R16-4 (V)) sign (see Section 2I-09 of this Supplement). If used, the two signs should be the same width.



## Section 2B.V1 Anti-Littering Signs (R0-V1, R0-V2)

## Option:

- 01 The following signs may be utilized where there is evidence of trash along the roadway or littering activity (see Figure 2B-V3 in this Supplement):
  1. NO DUMPING (R0-V1) signs;
  2. LITTERING IS ILLEGAL (R0-V2) signs.



## Section 2B.V2 Radar and Speed Limit Enforcement Signs (R0-V3, R0-V4, R0-V7\*)

## Support:

- 01 The following messages are used to convey Virginia-specific laws pertaining to speed limit enforcement and the use of radar detectors (see Figure 2B-V4 in this Supplement):
  1. SPEED CHECKED BY RADAR AND OTHER ELECTRICAL DEVICES (R0-V3)
  2. RADAR DETECTORS ILLEGAL (R0-V4)



### Figure 2B-V2 V3\*. Anti-Littering Signs



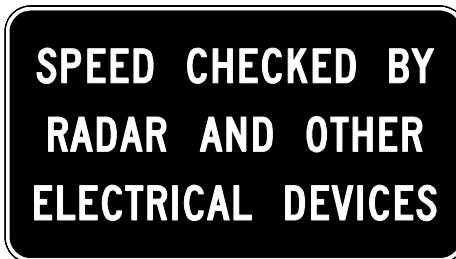
R0-V1



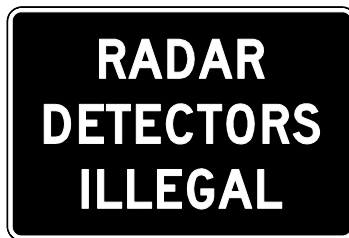
R0-V2



## Figure 2B-V3 V4\*. Radar and Speed Limit Enforcement Signs



R0-V3



R0-V4



R0-V7

### Standard:

- 02 In cooperation with the Virginia State Police (VSP), signs used to communicate speed limit enforcement and the use of radar detectors shall be installed on Interstate, U.S., and Primary routes at or near the State boundary facing traffic entering Virginia and at other locations determined by the VSP and engineering judgment.
- 03 Such signs shall have a white legend and border on a black background.
- 04 The SPEED LIMIT ENFORCED BY AIRCRAFT (R0-V7) sign (see Figure 2B-V3 V4\* in this Supplement) shall only be installed on interstate highways. The sign shall be installed in conjunction with the speed measurement markings described in Section 3B.21 of this Supplement.

### Support:

- 05 The Virginia General Assembly enacted legislation, effective July 1, 2000, amending § 46.2-882 of the Code of Virginia to allow the use of aircraft for enforcement of the speed limit on interstate highways. Speed measurement markings are used by the Virginia State Police with the Visual Average Speed Computer and Monitor (VASCAR) units within aircraft as a point of reference to determine the speed of vehicles.



## **Section 2B.V3 Highway Safety Corridor Signs (R0-V5, R0-V6, R0-9cP (V))**

### **Support:**

- 01 In accordance with the Code of Virginia §§ 33.1-223.2:8 and 46.2-947, Highway Safety Corridors are officially designated primary route segments with unusually high crash rates. Drivers committing traffic violations in these corridors are subject to higher fines than usual. Moving violation finds are no more than \$500, and criminal traffic offenses are no less than \$200.
- 02 HIGHWAY SAFETY CORRIDOR FINES (R0-V5) signs (see Figure 2B-V4 V5\* in this Supplement) are used to communicate the presence of an officially designated Highway Safety Corridor and the fines for violating one of Virginia's driving laws while driving within such an area.

### **Standard:**

- 03 **In accordance with the Code of Virginia, Highway Safety Corridors shall only be established on Virginia Primary and Interstate highways. Highway Safety Corridor signs shall only be installed on Virginia Primary and Interstate highways.**
- 04 **HIGHWAY SAFETY CORRIDOR FINES (R0-V5) signs shall be placed at the beginning of each officially designated Highway Safety Corridor and at other points throughout the corridor based on engineering judgment.**

### *Guidance:*

- 05 *Engineering judgment used in determining the location of HIGHWAY SAFETY CORRIDOR FINES (R0-V5) signs should take into consideration placement of these signs after entrance ramps to inform drivers that they are entering a Highway Safety Corridor.*

### **Standard:**

- 06 **A BEGIN (R3-9cP (V)) auxiliary plaque (see Section 2B.25 of this Supplement and Figure 2B-V4 V5\* in this Supplement) shall be placed above the R0-V5 sign denoting the beginning of the officially designated Highway Safety Corridor.**
- 07 **An END HIGHWAY SAFETY CORRIDOR (R0-V6) sign (see Figure 2B-V4 V5\* in this Supplement) shall be used to denote the end of the officially designated Highway Safety Corridor.**

### **Support:**

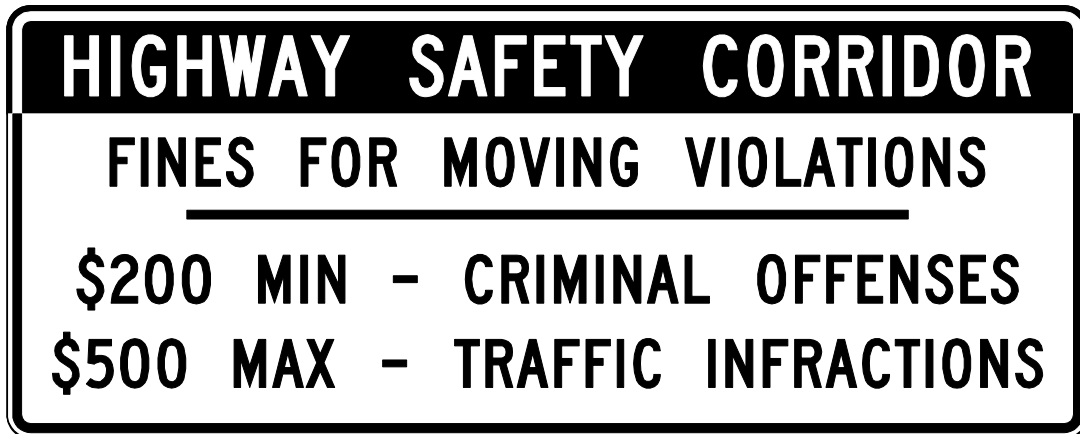
- 08 Additional information about the Highway Safety Corridor Program can be found on VDOT's web site (link provided in Appendix A of this Supplement).



## Figure 2B-V4 V5\*. Highway Safety Corridor Signs



R3-9cP (V)



R0-V5



R0-V6



### Section 2B.V4 Rest Area Directional Sign (R0-V8)

**Standard:**

- 01 Rest Area Directional Signs (R0-V8) (see Figure 2B-V5 V6\* in this Supplement) shall be installed at the entrances to Rest Areas to direct traffic to the appropriate parking area.

**Support:**

- 02 The Rest Area Directional Sign is designed for the specific layout of the individual Rest Area. The exact location and layout of the sign will vary depending on the specific Rest

Area to which it applies. Typical lines of text used on Rest Area Directional Signs include:

- A. CARS ONLY
- B. TRUCKS-BUSES
- C. ALL TOWED VEHICLES

*Guidance:*

- 03 *The placement and orientation of the arrows and the order of the lines of text should follow the guidelines in Section 2D.37 of the MUTCD.*



## **Section 2B.V5 TOWED VEHICLES Plaque (R2-VP1)**

Support:

- 01 The Code of Virginia § 46.2-870 establishes a speed limit of 45 miles per hour for vehicles being used to tow a vehicle designed for self-propulsion, or a house trailer.

*Guidance:*

- 02 *TOWED VEHICLES (R2-VP1) plaques (see Figure 2B-3(VA) in this Supplement) should be installed below SPEED LIMIT (R2-1) signs on roadways with a speed limit greater than 45 mph where there is a significant volume of towed vehicles.*



## **Section 2B.V6 NO FISHING FROM BRIDGE Signs (R9-V1)**

Option:

- 01 The NO FISHING FROM BRIDGE (R9-V1) sign (see Figure 2B-V6 V7\* in this Supplement) may be used at bridges from which fishing is prohibited.

*Guidance:*

- 02 *If used, R9-V1 signs should be installed at both ends of the bridge to communicate this prohibition to bridge users approaching from either direction.*



## **Figure 2B-V5 V6\*. Rest Area Directional Signs**



R0-V8



## Figure 2B-V6 V7\*. No Fishing From Bridge Signs



R9-V1



## Section 2B.V7 Commercial Vehicle Lane Restriction Signs (R4-V Series)

### Support:

- 01 In accordance with the Code of Virginia §§ 46.2-803.1 and 46.2-804, signs for communicating lane restrictions for commercial vehicles are listed below (see Figure 2B-V7 V8\* in this Supplement):
  1. COMMERCIAL VEHICLES EXCEPT BUSES USE RIGHT LANE WHEN OPERATED AT XX MPH OR BELOW (R4-V1);
  2. STEEP GRADE AHEAD (W7-VP1) plaque (see Section 2C.V2 of this Supplement);
  3. COMMERCIAL VEHICLES EXCEPT BUSES PROHIBITED IN LEFT LANE (R4-V2);
  4. TRUCKS & COMBINATION VEHICLES USE RIGHT LANE WHEN OPERATED BELOW XX MPH (R4-V4); and
  5. END COMMERCIAL VEHICLE RESTRICTION (R4-V3).

A commercial vehicle is defined in the Code of Virginia § 46.2-341.4.\*

### Standard:

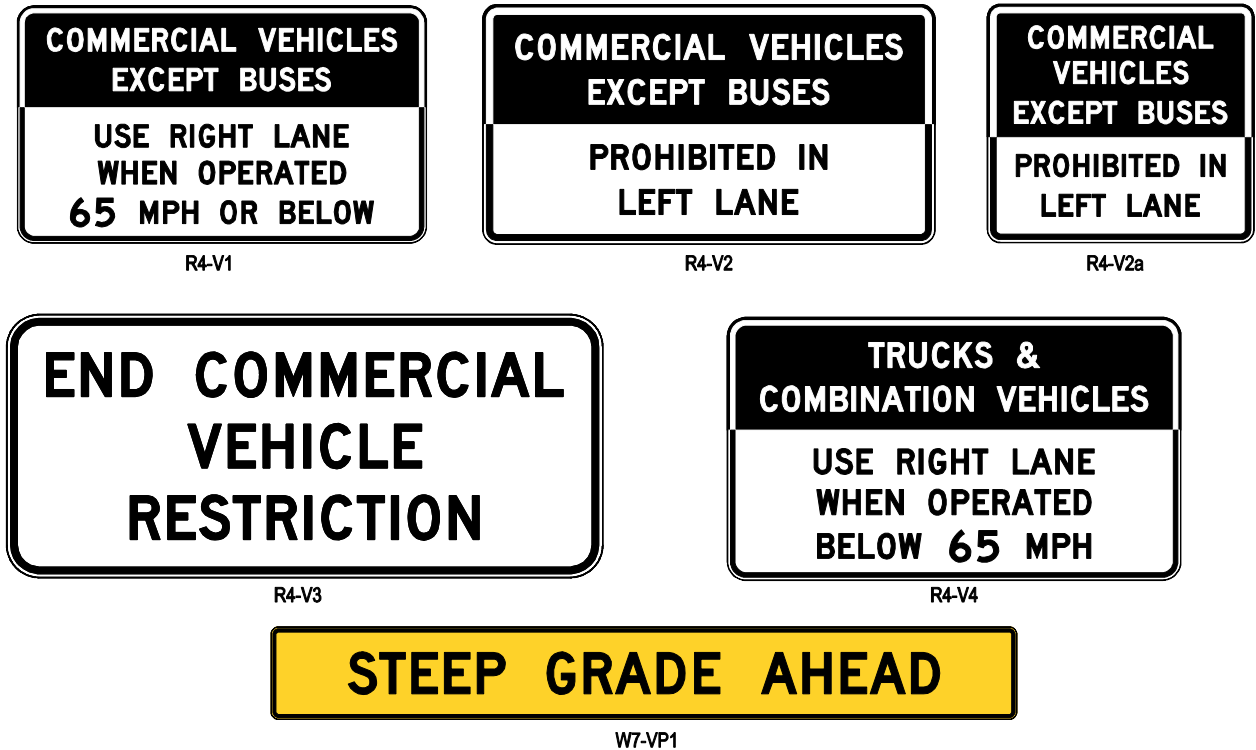
- 02 **R4-V1 or R4-V2 signs shall be installed at the beginning of each roadway segment where a commercial vehicle lane restriction exists and at other points within the roadway segment where engineering judgment determines these signs are necessary.**
- 03 **R4-V4 signs shall be installed at the beginning of each roadway segment where an engineering study justifies their use, taking into account factors such as grade and heavy vehicle volumes. The signs shall also be installed at other points within the roadway segment where engineering judgment determines these signs are necessary.**

### Option:

- 04 A reduced width version of the R4-V2 sign (R4-V2a) may be used when a narrow left shoulder precludes the use of a full width R4-V2 sign.
- 05 A STEEP GRADE AHEAD (W7-VP1) plaque (see Figure 2B-V7 V8\* in this Supplement) may be placed above an R4-V1 or R4-V4 sign (see Section 2C.V2 of this Supplement).



## Figure 2B-V7 V8\*. Commercial Vehicle Lane Restriction Signs



- 06 The END COMMERCIAL VEHICLE RESTRICTION (R4-V3) sign (see Figure 2B-V7 V8\* in this Supplement) shall be used at the end of the lane restrictions communicated by the R4-V1, R4-V2, and R4-V2a signs.



## Section 2B.V8 Pedestrian Swing Bridge Sign (R9-V2)

### Standard:

- 01 The Pedestrian Swing Bridge (R9-V2) sign (see Figure 2B-V8 V9\* in this Supplement) shall be installed at or within ten feet of each entry to pedestrian swing bridges.

### Support:

- 02 For additional information pertaining to signing for pedestrian swing bridges, refer to the Maintenance Division's "Maintenance Division Best Practices Manual," the location of which is shown in Appendix A of this Supplement.





## Figure 2B-V8 V9\*. Pedestrian Swing Bridge Sign



R9-V2

# CHAPTER 2C. WARNING SIGNS AND OBJECT MARKERS

## Section 2C.02 Application of Warning Signs

### Standard:

- 01 **The use of warning signs shall be based on an engineering study or on engineering judgment.**

### Guidance:

- 02 *The use of warning signs should be kept to a minimum as the unnecessary use of warning signs tends to breed disrespect for all signs. In situations where the condition or activity is seasonal or temporary, the warning sign should be removed or covered when the condition or activity does not exist.*

### Option:

- 03 Consistent with the provisions of Chapter 2L, changeable message signs may be used to display a warning message.
- 04 Consistent with the provisions of Chapter 4L, a Warning Beacon may be used in combination with a standard warning sign.

### Support:

- 05 The categories of warning signs are shown in [Table 2C-1\(VA\) in this Supplement](#).
- 06 Warning signs provided in [this Supplement and the MUTCD](#) cover most of the conditions that are likely to be encountered. Additional warning signs for low-volume roads (as defined in [Section 5A.01 of the MUTCD](#)), temporary traffic control zones, school areas, grade crossings, and bicycle facilities are discussed in Parts 5 through 9, respectively. For Part 6 refer to the latest edition of the “Virginia Work Area Protection Manual” (a link is provided in Appendix A of this Supplement).
- 07 [Section 1A.09 of this Supplement](#) contains information regarding the assistance that is available to jurisdictions that do not have engineers on their staffs who are trained and/or experienced in traffic control devices.

**Table 2C-1(VA). Categories of Warning Signs and Plaques**

Category	Group	Section	Signs or Plaques	Sign Designations	
Roadway Related	Changes in Horizontal Alignment	2C.07	Turn, Curve, Reverse Turn, Reverse Curve, Winding Road, Hairpin Curve, 270-Degree Curve	W1-1,2,3,4,5,11,15	
		2C.08	Advisory Speed	W13-1P	
		2C.09	Chevron Alignment	W1-8	
		2C.10	Combination Horizontal Alignment/Advisory Speed	W1-1a,2a	
		2C.11	Combination Horizontal Alignment/Intersection	W1-10,10a,10b,10c,10d	
		2C.12	Large Arrow (one direction)	W1-6	
		2C.13	Truck Rollover	W1-13	
		2C.14	Advisory Exit or Ramp Speed	W13-2,3	
	Vertical Alignment	2C.15	Combination Horizontal Alignment/Advisory Exit or Ramp Speed	W13-6,7	
		2C.16	Hill	W7-1,1a,2P,2bP,3P,3aP,3bP	
		2C.17	Truck Escape Ramp	W7-4,4b,4c,4dP,4eP,4fP	
	Cross Section	2C.18	Hill Blocks View	W7-6	
		2C.19	Road Narrows	W5-1	
		2C.20,21	Narrow Bridge, One Lane Bridge	W5-2,3	
		2C.22,23,25	Divided Highway, Divided Highway Ends, Double Arrow	W6-1,2; W12-1	
		2C.24	Freeway or Expressway Ends, All Traffic Must Exit	W19-1,2,3,4,5	
		2C.26	Dead End, No Outlet	W14-1,1a,2,2a	
	Roadway Surface Condition	2C.27	Low Clearance	W12-2,2a	
		2C.28,29	Bump, Dip, Speed Hump	W8-1,2; W17-1	
		2C.30	Pavement Ends	W8-3	
		2C.31	Shoulder, Uneven Lanes	W8-4,9,11,17,17P,23,25	
		2C.32	Slippery When Wet, Loose Gravel, Rough Road, Bridge Ices Before Road, Fallen Rocks	W8-5,7,8,13,14	
		2C.33	Grooved Pavement, <a href="#">Metal Bridge Deck</a> , <a href="#">Steel Grid Deck</a> , <a href="#">Expansion Joints</a> , <a href="#">Open Joints on Bridge</a>	W8-15,15P,16, W8-V1, W8-V2, W8-V3	
	Weather	2C.34	No Center Line	W8-12	
	Traffic Related	Advance Traffic Control	2C.35	Road May Flood, Flood Gauge, Gusty Winds Area, Fog Area	W8-18,19,21,22
		Traffic Flow	2C.36-39	Stop Ahead, Yield Ahead, Signal Ahead, Be Prepared To Stop, Speed Reduction, Drawbridge Ahead, Ramp Meter Ahead	W3-1,2,3,4,5,5a,6,7,8
			2C.40-45	Merge, No Merge Area, Lane Ends, Added Lane, Two-Way Traffic, Right Lane Exit Only Ahead, No Passing Zone	W4-1,2,3,5,5P,6; W6-3; W9-1,2,7; W14-3
Intersections		2C.46	Cross Road, Side Road, T, Y, Circular Intersection, Side Roads	W2-1,2,3,4,5,6,7,8; W16-12P,17P	
		2C.47	Large Arrow (two directions)	W1-7	
Vehicular Traffic	2C.48	Oncoming Extended Green	W25-1,2		
	2C.49	Truck Crossing, Truck (symbol), Emergency Vehicle, Tractor, Bicycle, Golf Cart, Horse-Drawn Vehicle, Trail Crossing, <a href="#">Rescue Squad</a> , <a href="#">Watch for Turning Vehicles</a>	W8-6; W11-1,5,5a,8,10,11 12P,14,15,15P,15a; W16-13P, W11-V1, W11-V3		

Category	Group	Section	Signs or Plaques	Sign Designations
	Non-Vehicular	2C.50,51, V1	Pedestrian, Deer, Cattle, Snowmobile, Equestrian, Wheelchair, Large Animals, Playground, <b>Watch for Children</b>	W11- 2,3,4,6,7,9,16,17,18,19, 20,21,22; W15-1; W16- 13P, <b>W15-V1</b>
	New	2C.52	New Traffic Pattern Ahead	W23-2
Other Supplemental Plaques	Location	2C.53	Downward Diagonal Arrow, Ahead	W16-7P,9P
	Distance	2C.55	XX Feet, XX Miles, Next XX Feet, Next XX Miles	W7-3aP; W16-2P,2aP,3P,3aP,4P
	Arrow	2C.56	Advance Arrow, Directional Arrow	W16-5P,6P
	Street Name Plaque	2C.58	Advance Street Name	W16-8P,8aP
	Intersection	2C.59	Cross Traffic Does Not Stop	W4-4P,4aP,4bP
	Share The Road	2C.60	Share The Road	W16-1P
	HOV	2C.53	High-Occupancy Vehicle	W16-11P
	Photo Enforced	2C.61	Photo Enforced	W16-10P,10aP
	New	2C.62	New	W16-15P
	<b>Commercial Vehicle Lane Restriction</b>	<b>2C.V2</b>	<b>Steep Grade Ahead (plaque)</b>	<b>W7-VP1</b>

**Table 2C-2(VA). Warning Sign and Plaque Sizes**

Sign or Plaque	Sign Designation	Section	Conventional Road		Expressway	Freeway	Minimum	Oversized
			Single Lane	Multi-Lane				
Horizontal Alignment	W1-1,2,3,4,5	2C.07	30 x 30*	36 x 36	36 x 36	36 x 36	—	48 x 48
Combination Horizontal Alignment/Advisory Speed	W1-1a,2a	2C.10	36 x 36	36 x 36	48 x 48	48 x 48	—	48 x 48
One-Direction Large Arrow	W1-6	2C.12	48 x 24	48 x 24	60 x 30	60 x 30	—	60 x 30
Two-Direction Large Arrow	W1-7	2C.47	48 x 24	48 x 24	—	—	—	60 x 30
Chevron Alignment	W1-8	2C.09	18 x 24	18 x 24	30 x 36	36 x 48	—	24 x 30
Combination Horizontal Alignment/Intersection	W1-10,10a, 10b,10c,10d,10e	2C.11	36 x 36	36 x 36	36 x 36	48 x 48	—	—
Hairpin Curve	W1-11	2C.07	30 x 30	30 x 30	36 x 36	48 x 48	—	48 x 48
Truck Rollover	W1-13	2C.13	<del>36 x 36</del> 48 x 48	<del>36 x 36</del> 48 x 48	<del>36 x 36</del> 48 x 48	48 x 48	—	<b>48 x 48</b>
<b>Truck Rollover</b>	<b>W1-13 (V)</b>	<b>2C.13</b>	—	—	—	—	—	<b>60 x 60</b>
270-degree Loop	W1-15	2C.07	30 x 30	30 x 30	36 x 36	48 x 48	—	48 x 48
Intersection Warning	W2-1,2,3,4,5,6,7,8	2C.46	30 x 30	30 x 30	36 x 36	—	24 x 24	48 x 48
Advanced Traffic Control	W3-1,2,3	2C.36	30 x 30	30 x 30	48 x 48	48 x 48	30 x 30	—
Be Prepared to Stop	W3-4	2C.36	36 x 36	36 x 36	48 x 48	48 x 48	30 x 30	—

Sign or Plaque	Sign Designation	Section	Conventional Road		Expressway	Freeway	Minimum	Oversized
			Single Lane	Multi-Lane				
Reduced Speed Limit Ahead	W3-5	2C.38	36 x 36	36 x 36	48 x 48	48 x 48	—	—
XX MPH Speed Zone Ahead	W3-5a	2C.38	36 x 36	36 x 36	48 x 48	48 x 48	—	—
Draw Bridge	W3-6	2C.39	36 x 36	36 x 36	48 x 48	—	—	60 x 60
Ramp Meter Ahead	W3-7	2C.37	36 x 36	36 x 36	—	—	—	—
Ramp Metered When Flashing	W3-8	2C.37	36 x 36	36 x 36	—	—	—	—
Merge	W4-1	2C.40	36 x 36	36 x 36	48 x 48	48 x 48	30 x 30*	—
Lane Ends	W4-2	2C.42	36 x 36	36 x 36	48 x 48	48 x 48	30 x 30*	—
Added Lane	W4-3	2C.41	36 x 36	36 x 36	48 x 48	48 x 48	30 x 30*	—
Cross Traffic Does Not Stop (plaque)	W4-4P	2C.59	24 x 12	24 x 12	36 x 18	—	—	48 x 24
Traffic From Left (Right) Does Not Stop (plaque)	W4-4aP	2C.59	24 x 12	24 x 12	36 x 18	—	—	48 x 24
Oncoming Traffic Does Not Stop (plaque)	W4-4bP	2C.59	24 x 12	24 x 12	36 x 18	—	—	48 x 24
Entering Roadway Merge	W4-5	2C.40	36 x 36	36 x 36	48 x 48	—	—	—
No Merge Area (plaque)	W4-5P	2C.40	18 x 24	18 x 24	24 x 30	—	—	—
Entering Roadway Added Lane	W4-6	2C.41	36 x 36	36 x 36	48 x 48	—	—	—
Road Narrows	W5-1	2C.19	36 x 36	36 x 36	48 x 48	48 x 48	30 x 30*	—
Narrow Bridge	W5-2	2C.20	36 x 36	36 x 36	48 x 48	48 x 48	30 x 30*	—
One Lane Bridge	W5-3	2C.21	36 x 36	36 x 36	48 x 48	48 x 48	30 x 30*	—
Divided Highway	W6-1	2C.22	36 x 36	36 x 36	48 x 48	48 x 48	—	—
Divided Highway Ends	W6-2	2C.23	36 x 36	36 x 36	48 x 48	48 x 48	—	—
Two-Way Traffic	W6-3	2C.44	36 x 36	36 x 36	48 x 48	48 x 48	—	—
Hill	W7-1	2C.16	30 x 30*	36 x 36	36 x 36	36 x 36	24 x 24*	48 x 48
Hill with Grade	W7-1a	2C.16	30 x 30*	36 x 36	36 x 36	36 x 36	24 x 24*	48 x 48
Use Low Gear (plaque)	W7-2P	2C.57	24 x 18	24 x 18	—	—	—	—
Trucks Use Lower Gear (plaque)	W7-2bP	2C.57	24 x 18	24 x 18	—	—	—	—
XX% Grade (plaque)	W7-3P	2C.57	24 x 18	24 x 18	—	—	—	—
Next XX Miles (plaque)	W7-3aP	2C.55	24 x 18	24 x 18	—	—	—	—
XX% Grade, XX Miles (plaque)	W7-3bP	2C.57	24 x 18	24 x 18	—	—	—	—
Runaway Truck Ramp XX Miles	W7-4	2C.17	78 x 48	78 x 48	78 x 48	78 x 48	—	—
Runaway Truck Ramp (with arrow)	W7-4b	2C.17	78 x 60	78 x 60	78 x 60	78 x 60	—	—
Truck Escape Ramp	W7-4c	2C.17	78 x 60	78 x 60	78 x 60	78 x 60	—	—
Sand, Gravel, Paved (plaques)	W7-4dP,4eP,4fP	2C.17	24 x 12	24 x 12	24 x 12	24 x 12	—	—
Hill Blocks View	W7-6	2C.18	30 x 30*	36 x 36	36 x 36	—	—	48 x 48

Sign or Plaque	Sign Designation	Section	Conventional Road		Expressway	Freeway	Minimum	Oversized
			Single Lane	Multi-Lane				
Bump or Dip	W8-1,2	2C.28	30 x 30*	36 x 36	36 x 36	48 x 48	24 x 24*	48 x 48
Pavement Ends	W8-3	2C.30	36 x 36	36 x 36	48 x 48	—	30 x 30*	—
Soft Shoulder	W8-4	2C.31	36 x 36	36 x 36	48 x 48	48 x 48	24 x 24*	48 x 48
Slippery When Wet	W8-5	2C.32	30 x 30*	36 x 36	36 x 36	48 x 48	24 x 24*	48 x 48
Road Condition (plaques)	W8-5P,5bP,5cP	2C.32	24 x 18	24 x 18	30 x 24	36 x 30	—	36 x 30
Ice	W8-5aP	2C.32	24 x 12	24 x 12	30 x 18	30 x 18	—	—
Truck Crossing	W8-6	2C.49	36 x 36	36 x 36	36 x 36	48 x 48	24 x 24*	48 x 48
Loose Gravel	W8-7	2C.32	36 x 36	36 x 36	36 x 36	—	24 x 24*	48 x 48
Rough Road	W8-8	2C.32	36 x 36	36 x 36	36 x 36	48 x 48	24 x 24*	48 x 48
Low Shoulder	W8-9	2C.31	36 x 36	36 x 36	36 x 36	48 x 48	24 x 24*	48 x 48
Uneven Lanes	W8-11	2C.32	36 x 36	36 x 36	36 x 36	48 x 48	—	48 x 48
No Center Line	W8-12	2C.34	36 x 36	36 x 36	36 x 36	48 x 48	—	—
Bridge Ices Before Road	W8-13	2C.32	36 x 36	36 x 36	36 x 36	48 x 48	24 x 24*	48 x 48
Fallen Rocks	W8-14	2C.32	30 x 30*	36 x 36	36 x 36	48 x 48	24 x 24*	48 x 48
Grooved Pavement	W8-15	2C.33	30 x 30*	36 x 36	36 x 36	48 x 48	24 x 24*	48 x 48
Motorcycle (plaque)	W8-15P	2C.33	24 x 18	24 x 18	30 x 24	36 x 30	—	36 x 30
<b>Metal Bridge Deck</b>	<b>W8-16</b>	<b>2C.33</b>	<b>30 x 30*</b>	<b>36 x 36</b>	<b>36 x 36</b>	<b>48 x 48</b>	<b>24 x 24*</b>	<b>48 x 48</b>
Shoulder Drop Off (symbol)	W8-17	2C.31	30 x 30*	36 x 36	36 x 36	48 x 48	24 x 24*	48 x 48
Shoulder Drop-Off (plaque)	W8-17P	2C.31	24 x 18	24 x 18	30 x 24	36 x 30	—	36 x 30
Road May Flood	W8-18	2C.35	36 x 36	36 x 36	36 x 36	48 x 48	24 x 24*	48 x 48
Flood Gauge	W8-19	2C.35	12 x 72	12 x 72	—	—	—	—
Gusty Winds Area	W8-21	2C.35	36 x 36	36 x 36	36 x 36	48 x 48	24 x 24*	48 x 48
Fog Area	W8-22	2C.35	36 x 36	36 x 36	36 x 36	48 x 48	24 x 24*	48 x 48
No Shoulder	W8-23	2C.31	36 x 36	36 x 36	36 x 36	48 x 48	24 x 24*	48 x 48
Shoulder Ends	W8-25	2C.31	30 x 30*	36 x 36	36 x 36	48 x 48	24 x 24*	48 x 48
Left (Right) Lane Ends	W9-1	2C.42	36 x 36	36 x 36	36 x 36	48 x 48	30 x 30*	48 x 48
Lane Ends Merge Left (Right)	W9-2	2C.42	36 x 36	36 x 36	36 x 36	48 x 48	30 x 30*	48 x 48
Right (Left) Lane Exit Only Ahead	W9-7	2C.43	132 x 72	132 x 72	132 x 72	132 x 72	—	—
Bicycle	W11-1	2C.49	30 x 30	30 x 30	36 x 36	—	24 x 24*	48 x 48
Pedestrian	W11-2	2C.50	30 x 30*	36 x 36	36 x 36	—	24 x 24*	48 x 48
Large Animals	W11-3,4,16,17,18,19,20,21,22	2C.50	30 x 30*	36 x 36	36 x 36	—	24 x 24*	48 x 48
Farm Vehicle	W11-5,5a	2C.49	30 x 30*	36 x 36	36 x 36	—	24 x 24*	48 x 48
Snowmobile	W11-6	2C.50	30 x 30*	36 x 36	36 x 36	—	24 x 24*	48 x 48
Equestrian	W11-7	2C.50	30 x 30*	36 x 36	36 x 36	—	24 x 24*	48 x 48
Emergency Vehicle	W11-8	2C.49	30 x 30*	36 x 36	36 x 36	—	24 x 24*	48 x 48
Handicapped	W11-9	2C.50	30 x 30*	36 x 36	36 x 36	—	—	48 x 48
Truck	W11-10	2C.49	30 x 30*	36 x 36	36 x 36	—	24 x 24*	48 x 48
Golf Cart	W11-11	2C.49	30 x 30*	36 x 36	36 x 36	—	24 x 24*	48 x 48

Sign or Plaque	Sign Designation	Section	Conventional Road		Expressway	Freeway	Minimum	Oversized
			Single Lane	Multi-Lane				
Emergency Signal Ahead (plaque)	W11-12P	2C.49	36 x 30	36 x 30	36 x 30	—	—	—
Horse-Drawn Vehicle	W11-14	2C.49	30 x 30*	36 x 36	36 x 36	—	24 x 24*	48 x 48
Bicycle / Pedestrian	W11-15	2C.49	30 x 30*	36 x 36	36 x 36	—	24 x 24*	48 x 48
Trail Crossing	W11-15a	2C.49	30 x 30*	36 x 36	36 x 36	—	24 x 24*	48 x 48
Trail X-ing (plaque)	W11-15P	2C.49	24 x 18	24 x 18	30 x 24	—	—	36 x 30
Double Arrow	W12-1	2C.25	30 x 30*	36 x 36	36 x 36	—	—	—
Low Clearance (with arrows)	W12-2	2C.27	36 x 36	36 x 36	48 x 48	48 x 48	30 x 30*	—
Low Clearance	W12-2a	2C.27	78 x 24	78 x 24	—	—	—	—
Advisory Speed (plaque)	W13-1P	2C.08	18 x 18	18 x 18	24 x 24	30 x 30	—	30 x 30
Advisory Exit or Ramp Speed	W13-2,3	2C.14	24 x 30	24 x 30	36 x 48	36 x 48	—	48 x 60
Combination Horizontal Alignment/ Advisory Exit or Ramp Speed	W13-6,7	2C.15	24 x 42	24 x 42	36 x 60	36 x 60	—	48 x 84
Dead End, No Outlet	W14-1,2	2C.26	30 x 30*	36 x 36	36 x 36	—	24 x 24*	48 x 48
Dead End, No Outlet (with arrow)	W14-1a,2a	2C.26	36 x 8	36 x 8	—	—	—	—
No Passing Zone (pennant)	W14-3	2C.45	48 x 48 x 36	48 x 48 x 36	—	—	40 x 40 x 30	64 x 64 x 48
Playground	W15-1	2C.51	30 x 30*	36 x 36	36 x 36	—	24 x 24*	48 x 48
Share the Road (plaque)	W16-1P	2C.60	18 x 24	18 x 24	24 x 30	—	—	24 x 30
XX Feet	W16-2P	2C.55	24 x 18	24 x 18	—	—	—	30 x 24
XX Ft	W16-2aP	2C.55	24 x 12	24 x 12	—	—	—	30 x 18
XX Miles (2-line plaque)	W16-3P	2C.55	30 x 24	30 x 24	—	—	—	—
XX Miles (1-line plaque)	W16-3aP	2C.55	30 x 12	30 x 12	—	—	—	—
Next XX Feet (plaque)	W16-4P	2C.55	30 x 24	30 x 24	—	—	—	—
Supplemental Arrow (plaque)	W16-5P,6P	2C.56	24 x 18	24 x 18	—	—	—	—
Downward Diagonal Arrow (plaque)	W16-7P	2C.50	24 x 12	24 x 12	—	—	—	30 x 18
Advance Street Name (1-line plaque)	W16-8P	2C.58	Varies x 8	Varies x 8	—	—	—	—
Advance Street Name (2-line plaque)	W16-8aP	2C.58	Varies x 15	Varies x 15	—	—	—	—
Ahead (plaque)	W16-9P	2C.50	24 x 12	24 x 12	30 x 18	—	—	—
Photo Enforced (symbol plaque)	W16-10P	2C.61	24 x 12	24 x 12	36 x 18	—	—	48 x 24
Photo Enforced (plaque)	W16-10aP	2C.61	24 x 18	24 x 18	36 x 30	—	—	48 x 36
HOV (plaque)	W16-11P	2G.09	24 x 12	24 x 12	30 x 18	—	—	30 x 18
Traffic Circle (plaque)	W16-12P	2C.46	24 x 18	24 x 18	—	—	—	—
When Flashing (plaque)	W16-13P	2C.50	24 x 18	24 x 18	—	—	—	—
New (plaque)	W16-15P	2C.62	24 x 12	24 x 12	—	—	—	—

Sign or Plaque	Sign Designation	Section	Conventional Road		Expressway	Freeway	Minimum	Oversized
			Single Lane	Multi-Lane				
Roundabout (plaque)	W16-17P	2C.46	24 x 12	24 x 12	—	—	—	—
NOTICE	W16-18P	2A.15	24 x 12	24 x 12	—	—	—	—
Speed Hump	W17-1	2C.29	30 x 30*	36 x 36	—	—	24 x 24*	48 x 48
Freeway Ends XX Miles	W19-1	2C.24	—	—	—	144 x 48	—	—
Expressway Ends XX Miles	W19-2	2C.24	—	—	144 x 48	—	—	—
Freeway Ends	W19-3	2C.24	—	—	—	48 x 48	—	—
Expressway Ends	W19-4	2C.24	—	—	48 x 48	—	—	—
All Traffic Must Exit	W19-5	2C.24	—	—	90 x 48	90 x 48	—	—
New Traffic Pattern Ahead	W23-2	2C.52	36 x 36	36 x 36	—	—	—	—
Traffic Signal Extended Green	W25-1,2	2C.48	24 x 30	24 x 30	—	—	—	—



## Virginia Specific Signs

STEEP GRADE AHEAD (plaque)	W7-VP1	2C.V2	—	144 x 18	144 x 18	144 x 18	—	—
STEEL GRID DECK	W8-V1	2C.33	36 x 36	48 x 48	60 x 60	60 x 60	—	—
EXPANSION JOINTS	W8-V2	2C.33	36 x 36	48 x 48	60 x 60	60 x 60	—	—
OPEN JOINTS ON BRIDGE	W8-V3	2C.33	36 x 36	48 x 48	60 x 60	60 x 60	—	—
RESCUE SQUAD	W11-V1	2C.49	30 x 30	36 x 36	—	—	—	48 x 48
WATCH FOR TURNING VEHICLES	W11-V3	2C.49	36 x 36	48 x 48	—	—	—	—
WATCH FOR CHILDREN	W15-V1	2C.V1	30 x 30	36 x 36	—	—	—	48 x 48
CLEANUP CREW WORKING**	W21-V6	2H.08	36 x 36	48 x 48	—	—	—	—

\* The minimum size required for diamond-shaped warning signs facing traffic on multi-lane conventional roads shall be 36" x 36" per [Section 2C.04](#) of the MUTCD.

\*\* This sign may be cut into two pieces (along the horizontal centerline axis) and hinged such that it can be folded when cleanup crews are not working.

- Notes
1. Larger signs may be used when appropriate
  2. Dimensions in inches are shown as width x height



## Section 2C.06 Horizontal Alignment Warning Signs (This Section has been added to the Virginia Supplement to the MUTCD - Revision 1.)\*

### Support:

- 01 A variety of horizontal alignment warning signs (see Figure 2C-1(VA) in this Supplement), pavement markings (see Chapter 3B), and delineation (see Chapter 3F) can be used to advise motorists of a change in the roadway alignment. Uniform application of these traffic control devices with respect to the amount of change in the roadway alignment conveys a consistent message establishing driver expectancy and promoting effective roadway operations. The design and application of horizontal alignment warning signs to meet those requirements are addressed in Sections 2C.06, 2C.08, and 2C.13 in this Supplement, and Sections 2C.07, 2C.09, 2C.10, 2C.11, 2C.12, 2C.14, and 2C.15 of the MUTCD.\*

### Standard:

- 02 In advance of horizontal curves on freeways, on expressways, and on roadways with more than 1,000 AADT that are functionally classified as arterials or collectors, horizontal alignment warning signs shall be used in accordance with Table 2C-5 based on the speed differential between the roadway's posted or statutory speed limit or 85th-percentile speed, whichever is higher, or the prevailing speed on the approach to the curve, and the horizontal curve's advisory speed.\*

### Option:

- 03 Horizontal Alignment Warning signs may also be used on other roadways or on arterial and collector roadways with less than 1,000 AADT based on engineering judgment.\*

### Guidance:

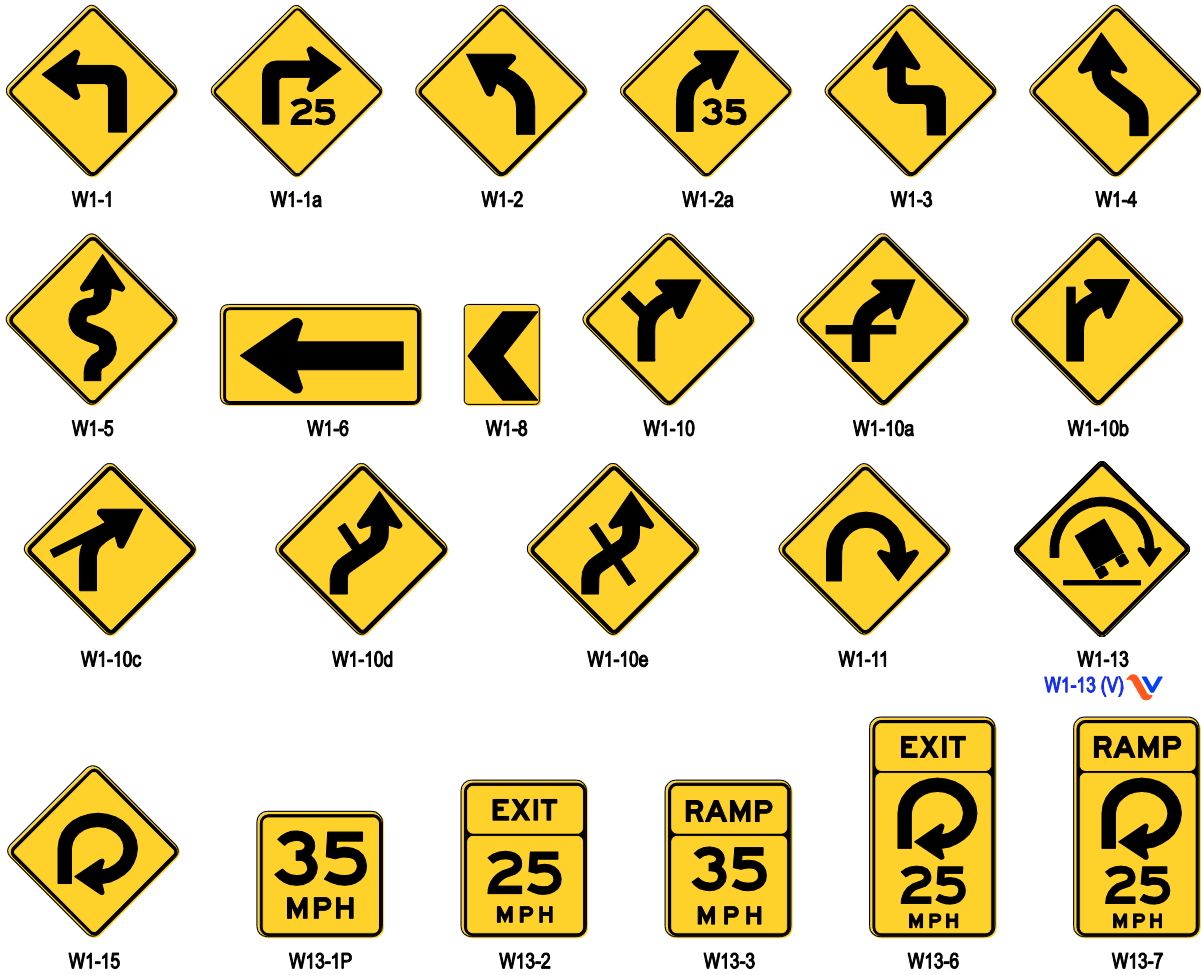
- 04 A traditional ball-bank indicator or other equivalent device should be used for determining the recommended advisory speed for a horizontal curve on an existing roadway (see Sections 2C.08 in this Supplement, and Section 2C.10 of the MUTCD for application of Horizontal Alignment Warning Signs and Advisory Speed Plaques).\*
- 05 When an equivalent device is used instead of a traditional ball-bank indicator, the device should be of equivalent accuracy to a traditional ball-bank indicator.\*

### Option:

- 06 A traditional ball-bank indicator or other equivalent device may be used for determining the recommended advisory speed to be displayed with an Advisory Exit Speed (W13-2) sign or an Advisory Ramp Speed (W13-3) sign (see Sections 2C.13 in this Supplement and 2C.14 and 2C.15 of the MUTCD for application of Advisory Exit Speed and Advisory Ramp Speed signs).\*



**Figure 2C-1(VA). Horizontal Alignment Signs and Plaques**



Note: Turn arrows and reverse turn arrows may be substituted for the curve arrows and reverse curve arrows on the W1-10 series signs where appropriate.

**Standard:**

07 The following criteria shall apply for ball-bank indicator readings:\*

- A. 16 degrees of ball-bank for posted speeds of 20 mph or less\*
- B. 14 degrees of ball-bank for posted speeds of 25 or 30 mph\*
- C. 12 degrees of ball-bank for posted speeds of 35 mph to 45 mph\*
- D. 10 degrees of ball-bank for posted speeds of 50 mph or greater\*

**Table 2C-5. Horizontal Alignment Sign Selection**

Type of Horizontal Alignment Sign	Difference Between Speed Limit and Advisory Speed				
	5 mph	10 mph	15 mph	20 mph	25 mph or more
Turn (W1-1), Curve (W1-2), Reverse Turn (W1-3), Reverse Curve (W1-4), Winding Road (W1-5), and Combination Horizontal Alignment/Intersection (W1-10 series) (see <a href="#">Section 2C.07 of the MUTCD</a> to determine which sign to use)	Recommended	Required	Required	Required	Required
Advisory Speed Plaque (W13-1P)	Recommended	Required	Required	Required	Required
Chevrons (W1-8) and/or One Direction Large Arrow (W1-6)	Optional	Recommended	Required	Required	Required
Exit Speed (W13-2) and Ramp Speed (W13-3) on exit ramp	Optional	Optional	Recommended	Required	Required

Note: Required means that the sign and/or plaque shall be used, recommended means that the sign and/or plaque should be used, and optional means that the sign and/or plaque may be used.

See [Section 2C.06 of the MUTCD](#) for roadways with less than 1,000 AADT.

**Support:**

- 08 [The 16, 14, and 12 degrees of ball-bank criteria are comparable to the current AASHTO horizontal curve design guidance.\\*](#)

## **Section 2C.08 Advisory Speed Plaque (W13-1P)**

**Option:**

- 01 The Advisory Speed (W13-1P) plaque (see [Figure 2C-1\(VA\) in this Supplement](#)) may be used to supplement any warning sign to indicate the advisory speed for a condition.

**Standard:**

- 02 **The use of the Advisory Speed plaque for horizontal curves shall be in accordance with the information shown in Table 2C-5. The Advisory Speed plaque shall also be used where an engineering study indicates a need to advise road users of the advisory speed for other roadway conditions.**
- 03 **If used, the Advisory Speed plaque shall carry the message XX MPH. The speed displayed shall be a multiple of 5 mph.**

- 04 **Except in emergencies or when the condition is temporary, an Advisory Speed plaque shall not be installed until the advisory speed has been determined by an engineering study.**
- 05 **The Advisory Speed plaque shall only be used to supplement a warning sign and shall not be installed as a separate sign installation.**
- 06 **The advisory speed shall be determined by an engineering study that follows established engineering practices.**

**Standard:**

- 07 ~~A traditional ball bank indicator shall be used for determining the recommended advisory speed for a horizontal curve on an existing roadway (see Section 2C.06 of the MUTCD for application of Horizontal Alignment Warning Signs and Plaques).~~

**Guidance:**

- 07 ~~For determining the recommended advisory speed for a horizontal curve a traditional ball-bank indicator or approved equivalent should be used. See Section 2C.06 in this Supplement for additional information related to the use of a ball-bank indicator for this purpose.\*~~

- 08 ~~The following criteria shall apply for ball bank indicator readings:\*~~

~~A. 16 degrees of ball bank for posted speeds of 20 mph or less\*~~

~~B. 14 degrees of ball bank for posted speeds of 25 or 30 mph\*~~

~~C. 12 degrees of ball bank for posted speeds of 35 mph to 45 mph\*~~

~~D. 10 degrees of ball bank for posted speeds of 50 mph or greater\*~~

**Support:**

- 09 ~~The 16, 14, and 12 degrees of ball bank criteria are comparable to the current AASHTO horizontal curve design guidance.\*~~

1008 ~~The advisory speed should be determined based on free-flowing traffic conditions.~~

1109 ~~Because changes in conditions, such as roadway geometrics, surface characteristics, or sight distance, might affect the advisory speed, each location should be evaluated periodically or when conditions change~~

## **Section 2C.13 Truck Rollover Warning Sign (W1-13, W1-13 (V))**

**Option:**

- 01 A Truck Rollover Warning (W1-13, [W1-13 \(V\)](#)) sign (see [Figure 2C-1\(VA\)](#) in this Supplement) may be used to warn drivers of vehicles with a high center of gravity, such as trucks, tankers, and recreational vehicles, of a curve or turn where geometric conditions might contribute to a loss of control and a rollover as determined by an engineering study.

**Support:**

- 02 Among the established engineering practices that are appropriate for the determination of the truck rollover potential of a horizontal curve are the following:
- A. An accelerometer that provides a direct determination of side friction factors
  - B. A design speed equation
  - C. A traditional ball-bank indicator using 10 degrees of ball-bank

**Standard:**

- 03 **If a Truck Rollover Warning (W1-13, W1-13 (V)) sign is used, it shall be accompanied by an Advisory Speed (W13-1P) plaque indicating the recommended speed for vehicles with a higher center of gravity.**

**Option:**

- 04 The Truck Rollover Warning sign may be displayed as a static sign, as a static sign supplemented by a flashing warning beacon, or as a changeable message sign activated by the detection of an approaching vehicle with a high center of gravity that is traveling in excess of the recommended speed for the condition.

**Support:**

- 05 The curved arrow on the Truck Rollover Warning sign shows the direction of roadway curvature. The truck tips in the opposite direction.

**Standard:**

- 06 **W1-13 signs shall be 48" x 48" in size at all locations except where engineering judgment determines that the oversized (60" x 60") W1-13 (V) sign panel is necessary. 36" x 36" W1-13 signs shall not be used.**
- 07 **Advisory Speed (W13-1P) plaques shall be 30" x 30" when used with all W1-13 and W1-13 (V) signs.**

## **Section 2C.21 ONE LANE BRIDGE Sign (W5-3)** (This Section has been added to the Virginia Supplement to the MUTCD - Revision 1.)\*

**Guidance:**

- 01 *A ONE LANE BRIDGE (W5-3) sign (see Figure 2C-5) should be used on two-way roadways in advance of any bridge or culvert: \**
- A. *Having a clear roadway width of less than 16 feet, or\**
  - B. *Having a clear roadway width of less than 18 feet when commercial vehicles constitute a high proportion of the traffic, or\**
  - C. *Having a clear roadway width of 18 feet or less where the sight distance is limited on the approach to the structure.\**
- 02 *Additional emphasis should be provided by the use of object markers, delineators, and/or pavement markings.\**

**Option:**

03 Typical signs and pavement markings that may be used on the approaches to a one lane bridge are shown in Figure 2C-V1.\*

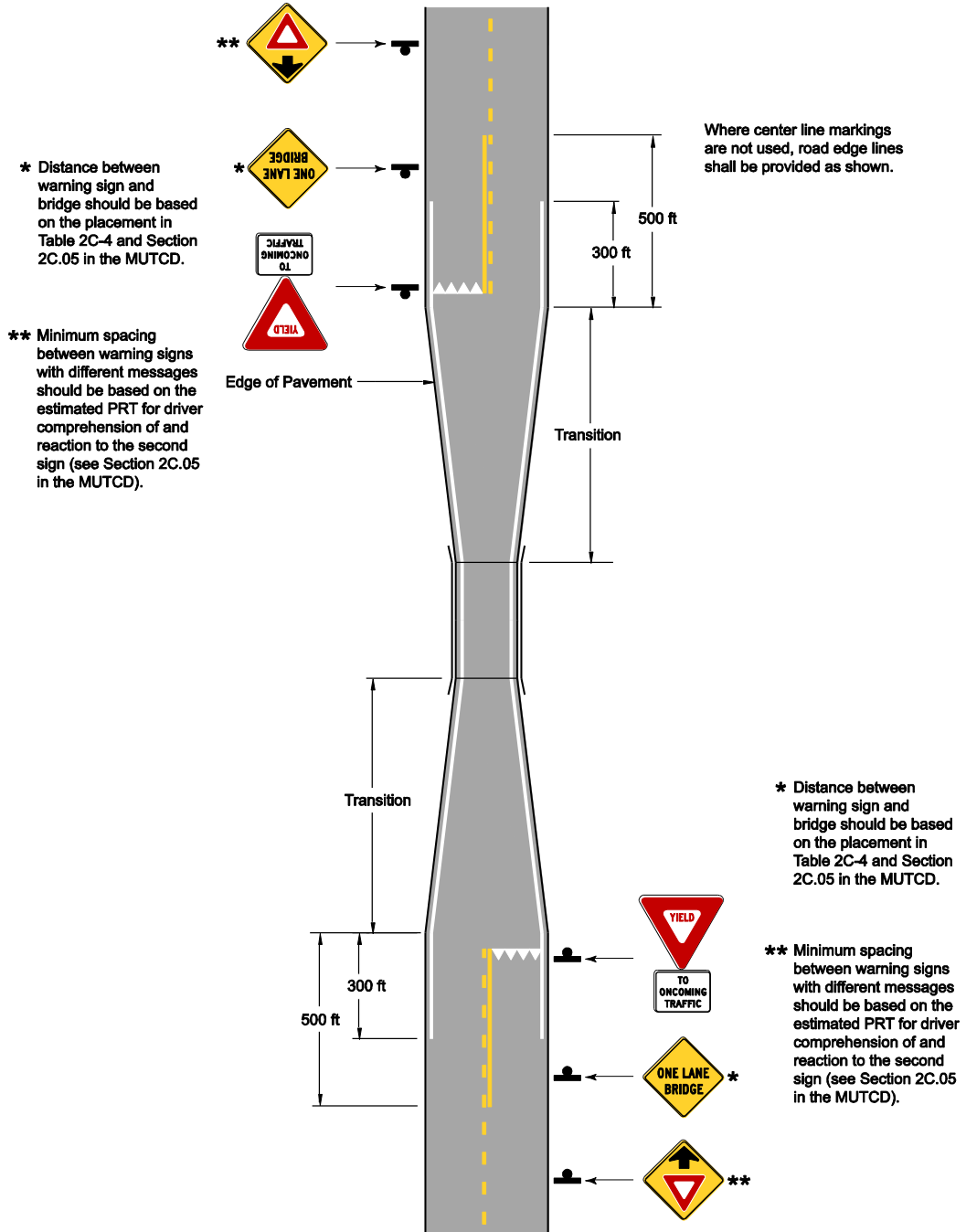
*Guidance:*

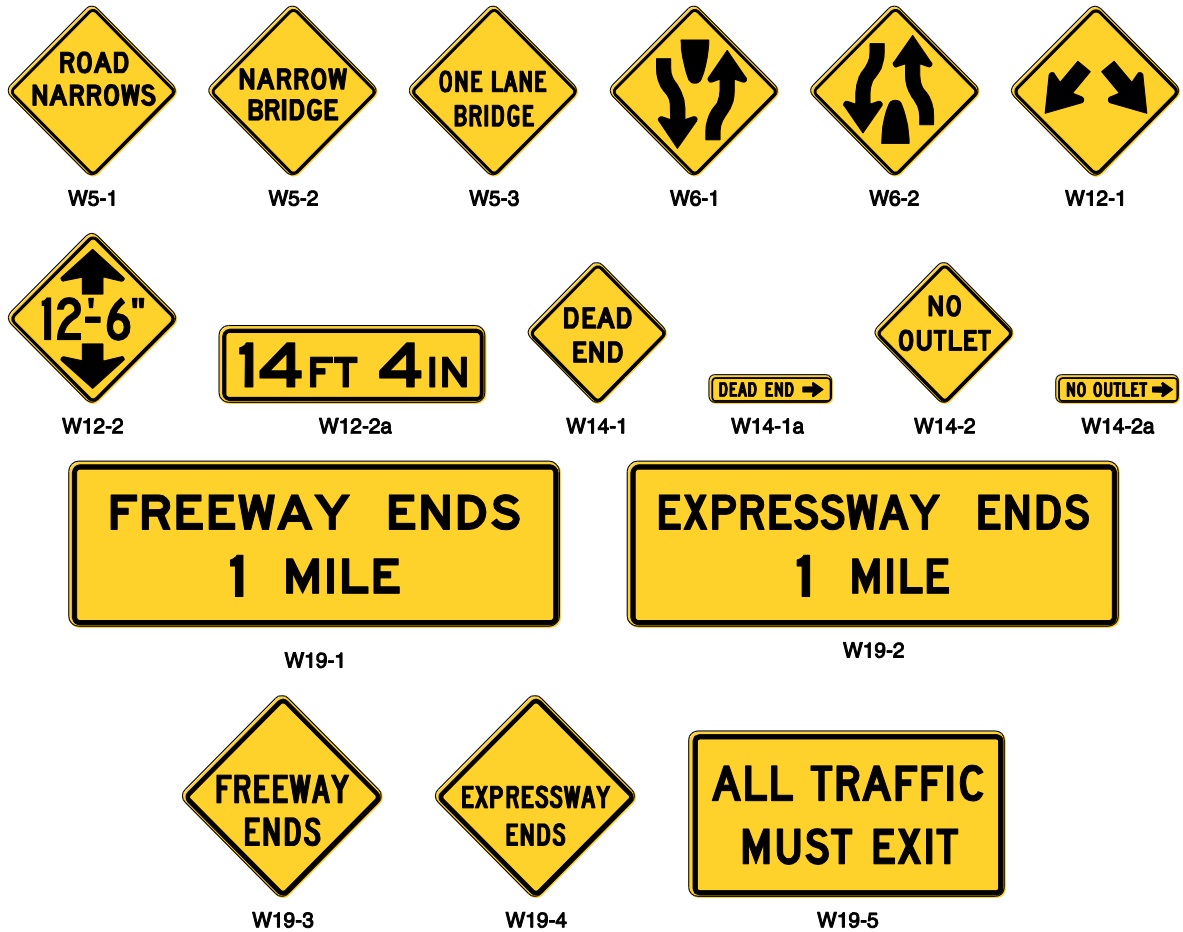
04 *If used, the distance between the ONE LANE BRIDGE (W5-3) sign and the bridge should be based on the distances in Table 2C-4 of the MUTCD. If multiple warning signs are\* used on the approaches to a one lane bridge, the minimum spacing between the warning signs should be based on the estimated PRT for driver comprehension of and reaction to the second sign (see Section 2C.05 in the MUTCD).\**



## Figure 2C-V1. Typical Signing and Markings for One Lane Bridge Approach

(This Figure has been added to the Virginia Supplement to the MUTCD - Revision 1.)\*



**Figure 2C-5. Miscellaneous Warning Signs****Section 2C.27 Low Clearance Signs (W12-2 and W12-2a)****Standard:**

- 01 The Low Clearance (W12-2) sign (see Figure 2C-5) shall be used to warn road users of clearances less than 12 inches above the statutory maximum vehicle height.

**Support:**

- 02 The Low Clearance signs are required in accordance with The Code of Virginia § 46.2-1110.

**Guidance:**

- 03 Where the clearance is less than the legal maximum vehicle height, the W12-2 sign with a supplemental distance plaque should be placed at the nearest intersecting road or wide point in the road at which a vehicle can detour or turn around.
- 04 In the case of an arch or other structure under which the clearance varies greatly, two or more signs should be used as necessary on the structure itself to give information as to the clearances over the entire roadway.





- 05 *Clearances should be evaluated periodically, particularly when resurfacing operations have occurred.*

Option:

- 06 The Low Clearance sign may be installed on or in advance of the structure. If a sign is placed on the structure, it may be a rectangular shape (W12-2a) with the appropriate legend (see Figure 2C-5).

**Standard:**

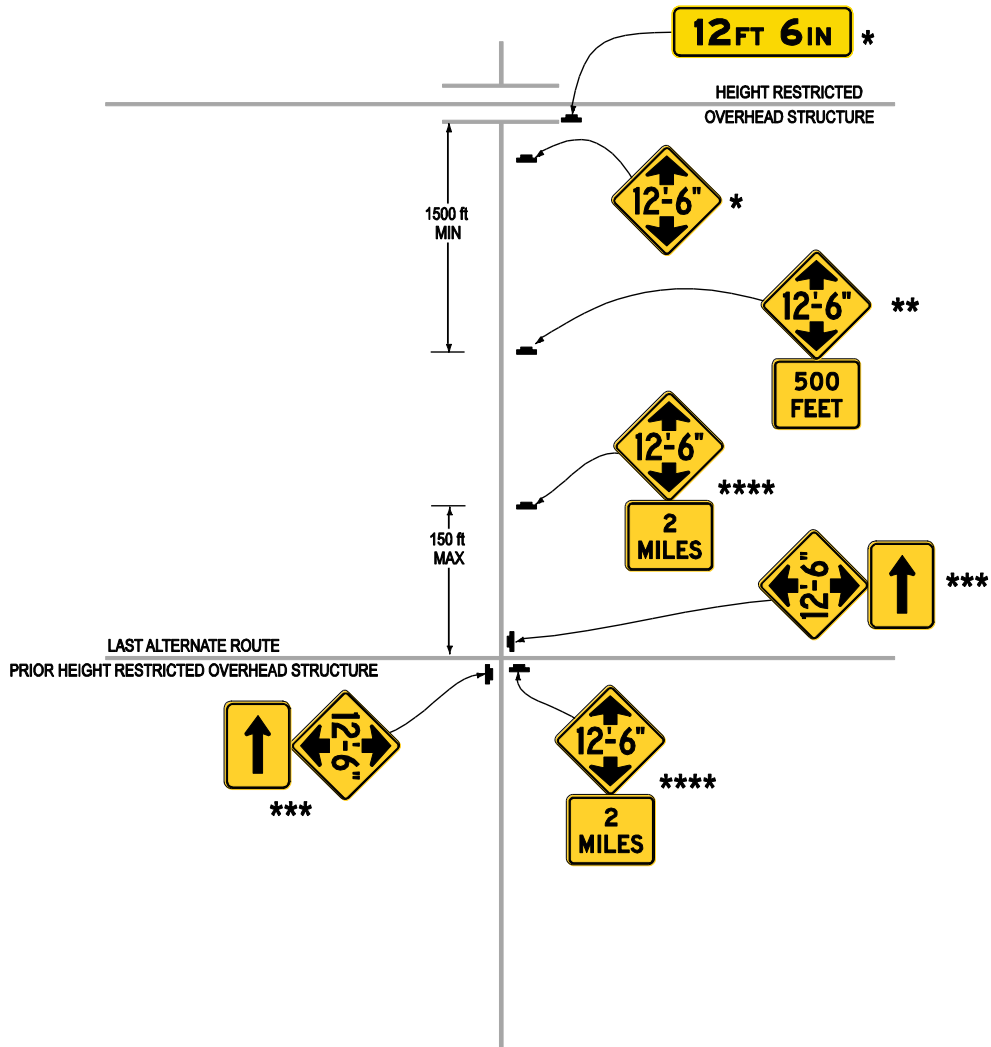
- 07 **Low Clearance signs shall be installed in accordance with Table 2C-V1. The vertical clearance posted on the signs shall be 3 inches less than the actual vertical clearance. Advance signs located on the alternate routes shall include the appropriate Supplemental Arrow (W16-6P) plaque (see Figure 2C-12) mounted below the W12-2 sign to indicate the direction of the structure. Figure 2C-V2 in this Supplement shows an example of such signing.\***





## Figure 2C-V2. Low Clearance Structure Signing

(This Figure has been added to the Virginia Supplement to the MUTCD in Revision 1.)\*



- \* Sign required: either the diamond warning sign or the rectangular warning sign. Both are not required.
- \*\* Sign required when actual clearance is less than or equal to 14'3"
- \*\*\* Sign required when actual clearance is less than 13'6"
- \*\*\*\* Sign recommended when actual clearance is less than 13'6"

Note: The vertical clearance posted on the signs shall be 3 inches less than the actual vertical clearance.



## Table 2C-V1. Minimum Signing for Vertical Clearances of Structures

(This table was reformatted in Revision 1, but the technical content did not change)\*

Actual Vertical Clearance <sup>1</sup>	Sign Locations <sup>2</sup>			
	Sign at Structure <sup>3</sup>	Sign at Least 1500 Feet In Advance Of Structure	Sign in Advance of Last Alternate Route <sup>4, 5, 6, 7</sup>	Sign 150 Feet (Max) Past the Last Alternate Route <sup>8</sup>
> 14'-5"	Optional*	Optional*	Optional*	Optional*
14'-4" to 14'-5"	Required	Recommended	Optional*	Optional*
13'-6" to 14'-3"	Required	Required	Optional	Optional
< 13'-6"	Required	Required	Required	Recommended

\* - These locations typically do not need warning signs, however a sign may be installed based upon engineering judgment.

Footnotes:

<sup>1</sup> As measured to the nearest inch not exceeding the actual clearance.

<sup>2</sup> Dual indication of signs may be needed on multi-lane roadways.

<sup>3</sup> At arched structures or structures under which the clearance varies greatly, two or more signs should be used as necessary on the structure itself to give information as to the clearances over the entire roadway.

<sup>4</sup> Placement distance of the signs in advance of the last alternate route shall be in accordance with Table 2C-4 in this Supplement.

<sup>5</sup> When signing in advance of the last alternate route is at least 1,500 feet in advance of the structure, this signing may suffice for the sign required 1,500 feet in advance of the structure.

<sup>6</sup> Where the advance alternate route is between the structure and the sign placed at least 1,500 feet in advance of the structure, engineering judgment shall be used to determine if signs at the last alternate route are needed.

<sup>7</sup> When other roadways exist between the last alternate route and the restricted structure, which may generate traffic that may exceed the height restrictions, consideration should be given to posting additional signs at those intersection locations.

<sup>8</sup> Discretion should be used in determining the effective placement of this sign. It may be desirable in some instances to place signs on the intersecting route approaches in lieu of past the alternate route to assure the signs are effective in alerting drivers to the restriction. On highways where the intersection of the last alternate route is via an interchange, signs should be installed on the alternate route for both directions.

### **Section 2C.28 BUMP and DIP Signs (W8-1, W8-2)**

*Guidance:*

- 01 *BUMP (W8-1) and DIP (W8-2) signs (see Figure 2C-6(VA) in this Supplement) should be used to give warning of a sharp rise or depression in the profile of the road.*

Option:

- 02 These signs may be supplemented with an Advisory Speed plaque (see [Section 2C.08 of this Supplement](#)).

Standard:

- 03 **The DIP sign shall not be used at a short stretch of depressed alignment that might momentarily hide a vehicle.**

Guidance:

- 04 *A short stretch of depressed alignment that might momentarily hide a vehicle should be treated as a no-passing zone when center line striping is provided on a two-lane or three-lane road (see [Section 3B.02 of the MUTCD](#)).*

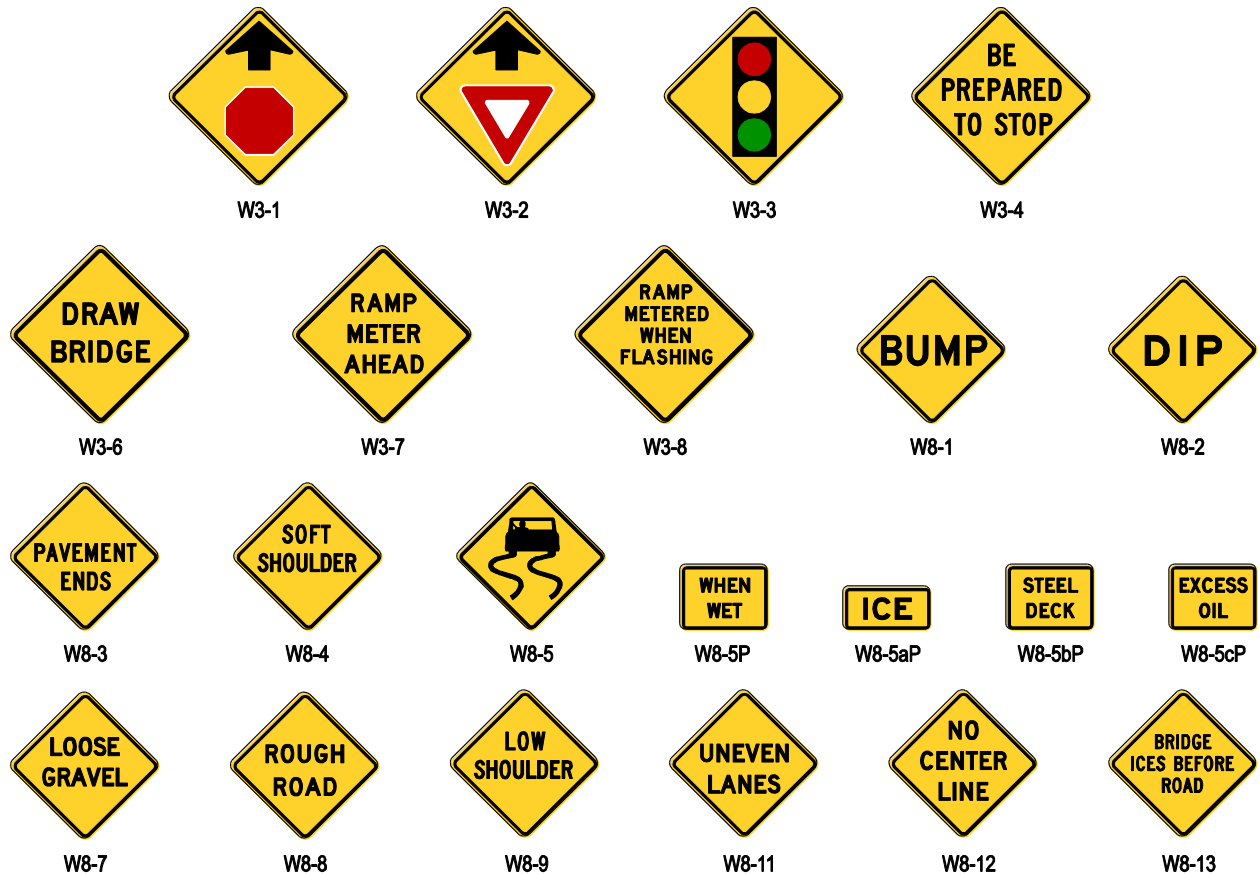


## **Section 2C.33 Warning Signs and Plaques for Motorcyclists** **(W8-15, W8-15P, ~~W8-16~~, W8-V1, W8-V2, and W8-V3)**

Support:

- 01 The signs and plaques described in this Section are intended to give motorcyclists advance notice of surface conditions that might adversely affect their ability to maintain control of their motorcycle under wet or dry conditions. The use of some of the advance surface condition warning signs described in [Section 2C.32 of the MUTCD](#), such as Slippery When Wet, LOOSE GRAVEL, or ROUGH ROAD, can also be helpful to motorcyclists if those conditions exist.

**Figure 2C-6(VA). Roadway and Weather Condition and Advance Traffic Control Signs and Plaques (Sheet 1 of 2)**



**Option:**

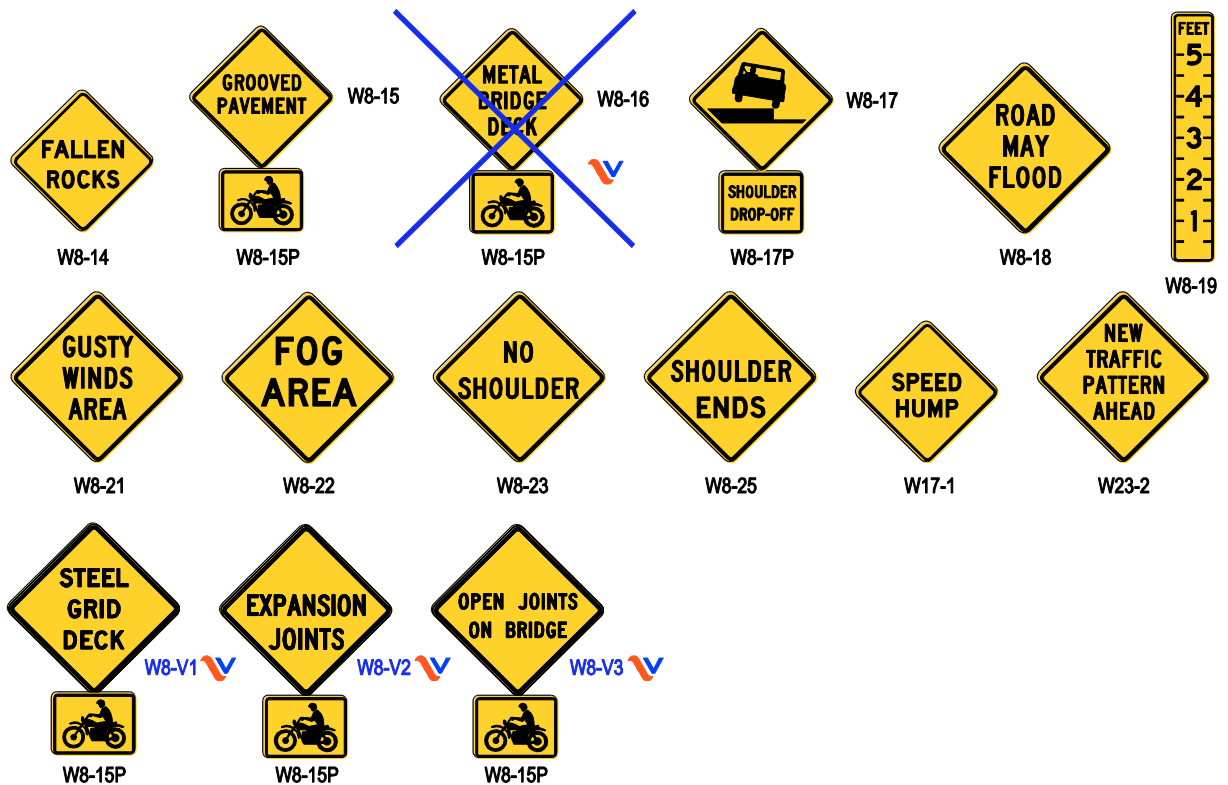
- 02 If a portion of a street or highway features a roadway pavement surface that is grooved or textured instead of smooth, such as a grooved skid resistance treatment for a horizontal curve or a brick pavement surface, a GROOVED PAVEMENT (W8-15) sign (see [Figure 2C-6\(VA\) in this Supplement](#)) may be used to provide advance warning of this condition to motorcyclists, bicyclists, and other road users. Alternate legends such as TEXTURED PAVEMENT or BRICK PAVEMENT may also be used on the W8-15 sign.

**Standard:**

- 03 **When used, Warning Signs and Plaques for Motorcyclists shall be placed in advance of the condition (see Table 2C-4).**
- 04 **If a portion of a bridge includes a grated surface or metal deck, a STEEL GRID DECK (W8-V1) sign (see Figure 2C-6(VA) in this Supplement) shall be installed in advance to provide warning of this condition to motorcyclists, bicyclists, and other road users.**



**Figure 2C-6(VA). Roadway and Weather Condition and Advance Traffic Control Signs and Plaques (Sheet 2 of 2)**



**Support:**

- 05 If a bridge deck is composed entirely of a metal deck (i.e., not featuring a grated surface), a METAL BRIDGE DECK (W8-16) sign (see Figure 2C-6(VA) in this Supplement) should be installed in advance to provide warning of this condition to motorcyclists, bicyclists, and other road users.

**Standard:**

- 06 An OPEN JOINTS ON BRIDGE (W8-V3) sign (see Figure 2C-6(VA) in this Supplement) shall be installed on all bridges where open longitudinal joints are in the travel lanes. These signs shall be installed for longitudinal joints that meet both of the following criteria:
1. The longitudinal joint is parallel or no more than 30 degrees from parallel to the travel lane.
  2. The longitudinal joint width is equal to or greater than 1.5 inches.

**Option:**

- 07 The OPEN JOINTS ON BRIDGE (W8-V3) sign may be used at locations only meeting Criterion 1 in Paragraph 6 above.

*Guidance:*

- 08 *An OPEN JOINTS ON BRIDGE (W8-V3) sign should be installed if longitudinal joints create an unlevel riding surface during cold weather contraction.*

*Guidance:*


- 09 *An EXPANSION JOINTS (W8-V2) sign (see Figure 2C-6(VA) in this Supplement) should be installed in advance of a bridge to warn motorists of transverse expansion joints. A field review should be performed to evaluate the location, condition and size of the joints on the bridge to determine if there are adverse surface conditions.*

**Standard:**

- 10 **A Motorcycle (W8-15P) plaque (see Figure 2C-6(VA) in this Supplement) shall be mounted below a W8-15, W8-V1, W8-V2, or W8-V3 sign to emphasize the warning to motorcyclists.**

## **Section 2C.38 Reduced Speed Limit Ahead Signs (W3-5, W3-5a)**

*Guidance:*

- 
- 01 *A Reduced Speed Limit Ahead (W3-5) sign (see Figure 2C-7(VA) in this Supplement) should be used to inform road users of a reduced speed zone where the speed limit is being reduced by more than 10 mph, or where engineering judgment indicates the need for advance notice to comply with the posted speed limit ahead. If used, the symbolic Reduced Speed Limit Ahead (W3-5) sign should be used and the text Reduced Speed Limit Ahead sign (W3-5a) sign should not be used.*

**Standard:**

- 02 **If used, Reduced Speed Limit Ahead signs shall be followed by a Speed Limit (R2-1) sign installed at the beginning of the zone where the speed limit applies.**
- 03 **The speed limit displayed on the Reduced Speed Limit Ahead sign shall be identical to the speed limit displayed on the subsequent Speed Limit sign.**

## Table 2C-4. Guidelines for Advance Placement of Warning Signs

Posted or 85th-Percentile Speed	Advance Placement Distance <sup>1</sup>								
	Condition A: Speed reduction and lane changing in heavy traffic <sup>2</sup>	Condition B: Deceleration to the listed advisory speed (mph) for the condition							
		0 <sup>3</sup>	10 <sup>4</sup>	20 <sup>4</sup>	30 <sup>4</sup>	40 <sup>4</sup>	50 <sup>4</sup>	60 <sup>4</sup>	70 <sup>4</sup>
20 mph	225 ft	100 ft <sup>6</sup>	N/A <sup>5</sup>	—	—	—	—	—	—
25 mph	325 ft	100 ft <sup>6</sup>	N/A <sup>5</sup>	N/A <sup>5</sup>	—	—	—	—	—
30 mph	460 ft	100 ft <sup>6</sup>	N/A <sup>5</sup>	N/A <sup>5</sup>	—	—	—	—	—
35 mph	565 ft	100 ft <sup>6</sup>	N/A <sup>5</sup>	N/A <sup>5</sup>	N/A <sup>5</sup>	—	—	—	—
40 mph	670 ft	125 ft	100 ft <sup>6</sup>	100 ft <sup>6</sup>	N/A <sup>5</sup>	—	—	—	—
45 mph	775 ft	175 ft	125 ft	100 ft <sup>6</sup>	100 ft <sup>6</sup>	N/A <sup>5</sup>	—	—	—
50 mph	885 ft	250 ft	200 ft	175 ft	125 ft	100 ft <sup>6</sup>	—	—	—
55 mph	990 ft	325 ft	275 ft	225 ft	200 ft	125 ft	N/A <sup>5</sup>	—	—
60 mph	1,100 ft	400 ft	350 ft	325 ft	275 ft	200 ft	100 ft <sup>6</sup>	—	—
65 mph	1,200 ft	475 ft	450 ft	400 ft	350 ft	275 ft	200 ft	100 ft <sup>6</sup>	—
70 mph	1,250 ft	550 ft	525 ft	500 ft	450 ft	375 ft	275 ft	150 ft	—
75 mph	1,350 ft	650 ft	625 ft	600 ft	550 ft	475 ft	375 ft	250 ft	100 ft <sup>6</sup>

<sup>1</sup> The distances are adjusted for a sign legibility distance of 180 feet for Condition A. The distances for Condition B have been adjusted for a sign legibility distance of 250 feet, which is appropriate for an alignment warning symbol sign. For Conditions A and B, warning signs with less than 6-inch legend or more than four words, a minimum of 100 feet should be added to the advance placement distance to provide adequate legibility of the warning sign.

<sup>2</sup> Typical conditions are locations where the road user must use extra time to adjust speed and change lanes in heavy traffic because of a complex driving situation. Typical signs are Merge and Right Lane Ends. The distances are determined by providing the driver a PRT of 14.0 to 14.5 seconds for vehicle maneuvers (2004 AASHTO Policy, Exhibit 3-3, Decision Sight Distance, Avoidance Maneuver E) minus the legibility distance of 180 feet for the appropriate sign.

<sup>3</sup> Typical condition is the warning of a potential stop situation. Typical signs are Stop Ahead, Yield Ahead, Signal Ahead, and Intersection Warning signs. The distances are based on the 2004 AASHTO Policy, Exhibit 3-1, Stopping Sight Distance, providing a PRT of 2.5 seconds, a deceleration rate of 11.2 feet/second<sup>2</sup>, minus the sign legibility distance of 180 feet.

<sup>4</sup> Typical conditions are locations where the road user must decrease speed to maneuver through the warned condition. Typical signs are Turn, Curve, Reverse Turn, or Reverse Curve. The distance is determined by providing a 2.5 second PRT, a vehicle deceleration rate of 10 feet/second<sup>2</sup>, minus the sign legibility distance of 250 feet.

<sup>5</sup> No suggested distances are provided for these speeds, as the placement location is dependent on site conditions and other signing. An alignment warning sign may be placed anywhere from the point of curvature up to 100 feet in advance of the curve. However, the alignment warning sign should be installed in advance of the curve and at least 100 feet from any other signs.

<sup>6</sup> The minimum advance placement distance is listed as 100 feet to provide adequate spacing between signs.





## **Section 2C.49 Vehicular Traffic Warning Signs (W8-6, W11-1, W11-5, W11-5a, W11-8, W11-10, W11-11, W11-12P, W11-14, W11-15, and W11-15a, W11-V1, W11-V3)**

### Option:



- 01 Vehicular Traffic Warning (W8-6, W11-1, W11-5, W11-5a, W11-8, W11-10, W11-11, W11-12P, W11-14, W11-15, W11-15a, [W11-V1](#), and [W11-V3](#)) signs (see [Figure 2C-10\(VA\) in this Supplement](#)) may be used to alert road users to locations where unexpected entries into the roadway by trucks, bicyclists, farm vehicles, emergency vehicles, golf carts, horse-drawn vehicles, or other vehicles might occur. The TRUCK CROSSING (W8-6) word message sign may be used as an alternate to the Truck Crossing (W11-10) symbol sign.
- 02 [The WATCH FOR TURNING VEHICLES \(W11-V3\) sign \(see Figure 2C-10\(VA\) in this Supplement\)](#) may be used in advance of intersections or driveways with a high daily turning volumes or conditions which justify advance warning.

### Standard:

- 03 **The WATCH FOR TURNING VEHICLES (W11-V3) sign shall not be used on a controlled approach.**

### Support:

- 04 These locations might be relatively confined or might occur randomly over a segment of roadway.

### Guidance:



- 05 *Vehicular Traffic Warning signs should be used only at locations where the road user's sight distance is restricted, or the condition, activity, or entering/turning traffic would be unexpected.*
- 06 *If the condition or activity is seasonal or temporary, the Vehicular Traffic Warning sign should be removed or covered when the condition or activity does not exist.*



- 07 *Vehicular traffic warning signs should not be used in place of intersection warning signs. At lower volume driveways or intersections, the appropriate intersection warning sign (W2-1 through W2-8) should be used, if necessary (see Section 2C.46 of the MUTCD).*

### Option:

- 08 The combined Bicycle/Pedestrian (W11-15) sign may be used where both bicyclists and pedestrians might be crossing the roadway, such as at an intersection with a shared-use path. A TRAIL X-ING (W11-15P) supplemental plaque (see [Figure 2C-10\(VA\) in this Supplement](#)) may be mounted below the W11-15 sign. The TRAIL CROSSING (W11-15a) sign may be used to warn of shared-use path crossings where pedestrians, bicyclists, and other user groups might be crossing the roadway.

### Standard:



- 09 **The W11-1, W11-15, and W11-15a signs and their related supplemental plaques shall have a fluorescent yellow-green background with a black legend and border.**

**Option:**

- 10 Supplemental plaques (see [Section 2C.53 of the MUTCD](#)) with legends such as AHEAD, XX FEET, NEXT XX MILES, or SHARE THE ROAD may be mounted below Vehicular Traffic Warning signs to provide advance notice to road users of unexpected entries.

**Guidance:**

- 11 *If used in advance of a pedestrian and bicycle crossing, a W11-15 or W11-15a sign should be supplemented with an AHEAD or XX FEET plaque to inform road users that they are approaching a point where crossing activity might occur.*

**Standard:**

- 12 **If a post-mounted W11-1, W11-11, W11-15, or W11-15a sign is placed at the location of the crossing point where golf carts, pedestrians, bicyclists, or other shared-use path users might be crossing the roadway, a diagonal downward pointing arrow (W16-7P) plaque (see [Figure 2C-12](#)) shall be mounted below the sign. If the W11-1, W11-11, W11-15, or W11-15a sign is mounted overhead, the W16-7P supplemental plaque shall not be used.**

**Option:**

- 13 The crossing location identified by a W11-1, W11-11, W11-15, or W11-15a sign may be defined with crosswalk markings (see [Section 3B.18 of this Supplement](#)).

**Standard:**

- 14 **The Emergency Vehicle (W11-8) sign (see [Figure 2C-10\(VA\) in this Supplement](#)) with the EMERGENCY SIGNAL AHEAD (W11-12P) supplemental plaque (see [Figure 2C-10\(VA\) in this Supplement](#)) shall be placed in advance of all emergency-vehicle traffic control signals (see [Chapter 4G of the MUTCD](#)).**

**Option:**

- 15 The Emergency Vehicle (W11-8) symbol sign (see [Figure 2C-10\(VA\) in this Supplement](#)) may be used in advance of a fire station when no emergency-vehicle traffic control signal is present.
- 16 The RESCUE SQUAD (W11-V1) word message sign (see [Figure 2C-10\(VA\) in this Supplement](#)) may be used in advance of a rescue station ~~when~~<sup>where</sup>\* no emergency-vehicle traffic control signal is present.

**Guidance:**

- 17 *The RESCUE SQUAD (W11-V1) word message sign should only be used where rescue equipment exists, but no fire apparatus exists. \* The Emergency Vehicle (W11-8) symbol sign and RESCUE SQUAD (W11-V1) word message sign should not be installed on the same sign post to warn drivers of a single facility. The most appropriate sign for the facility should be chosen ~~and installed independently~~.\**

**Option:**

- 18 A Warning Beacon (see [Section 4L.03 of the MUTCD](#)) may be used with any Vehicular Traffic Warning sign to indicate specific periods when the condition or activity is present or is likely to be present, or to provide enhanced sign conspicuity.

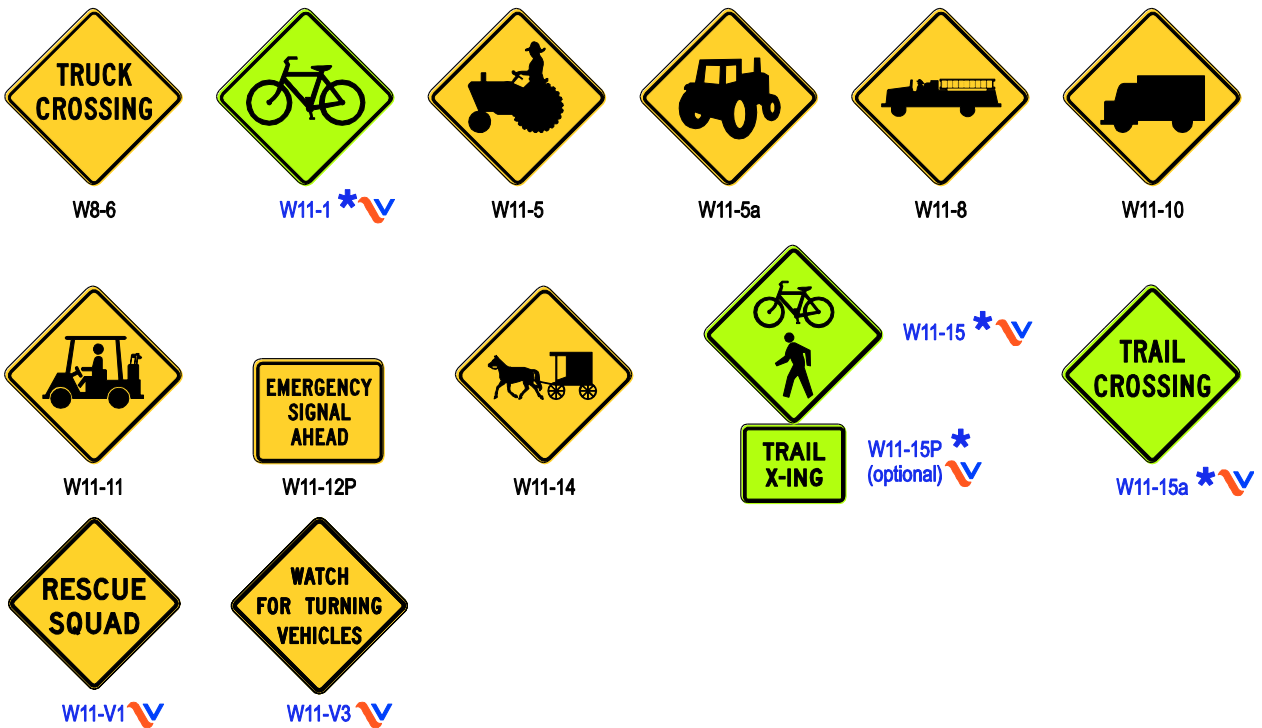


- 19 A supplemental WHEN FLASHING (W16-13P) plaque (see Figure 2C-12) may be used with any Vehicular Traffic Warning sign that is supplemented with a Warning Beacon to indicate specific periods when the condition or activity is present or is likely to be present.

**Figure 2C-7(VA). Reduced Speed Limit Ahead Signs**



**Figure 2C-10(VA). Vehicular Traffic Warning Signs and Plaques**



\* A fluorescent yellow-green background color shall be used for this sign or plaque.

## **Section 2C.50 Non-Vehicular Warning Signs (W11-2, W11-3, W11-4, W11-6, W11-7, W11-9, and W11-16 through W11-22)**

### Option:

- 01 Non-Vehicular Warning (W11-2, W11-3, W11-4, W11-6, W11-7, W11-9, and W11-16 through W11-22) signs (see [Figure 2C-11\(VA\) in this Supplement](#)) may be used to alert road users in advance of locations where unexpected entries into the roadway might occur or where shared use of the roadway by pedestrians, animals, or equestrians might occur.

### Support:

- 02 These conflicts might be relatively confined, or might occur randomly over a segment of roadway.

### Guidance:

- 03 *If used in advance of a pedestrian, snowmobile, or equestrian crossing, the W11-2, W11-6, W11-7, and W11-9 signs should be supplemented with plaques (see [Section 2C.55 of the MUTCD](#)) with the legend AHEAD or XX FEET to inform road users that they are approaching a point where crossing activity might occur.*

### Standard:

- 04 **If a post-mounted W11-2, W11-6, W11-7, or W11-9 sign is placed at the location of the crossing point where pedestrians, snowmobilers, or equestrians might be crossing the roadway, a diagonal downward pointing arrow (W16-7P) plaque (see [Figure 2C-12](#)) shall be mounted below the sign. If the W11-2, W11-6, W11-7, or W11-9 sign is mounted overhead, the W16-7P plaque shall not be used.**

### Option:

- 05 A Pedestrian Crossing (W11-2) sign may be placed overhead or may be post-mounted with a diagonal downward pointing arrow (W16-7P) plaque at the crosswalk location where [Yield Here To Pedestrians](#) signs (see [Section 2B.11 of this Supplement](#)) have been installed in advance of the crosswalk.



**Figure 2C-11(VA). Non-Vehicular Warning Signs**

\* A fluorescent yellow-green background color shall be used for this sign or plaque. 

#### Standard:

- 06 If a W11-2 sign has been post-mounted at the crosswalk location where a **Yield Here To Pedestrians** sign is used on the approach, the **Yield Here To Pedestrians** sign shall not be placed on the same post as or block the road user's view of the W11-2 sign.

#### Option:

- 07 An advance Pedestrian Crossing (W11-2) sign with an AHEAD or a distance supplemental plaque may be used in conjunction with a **Yield Here To Pedestrians** sign on the approach to the same crosswalk.

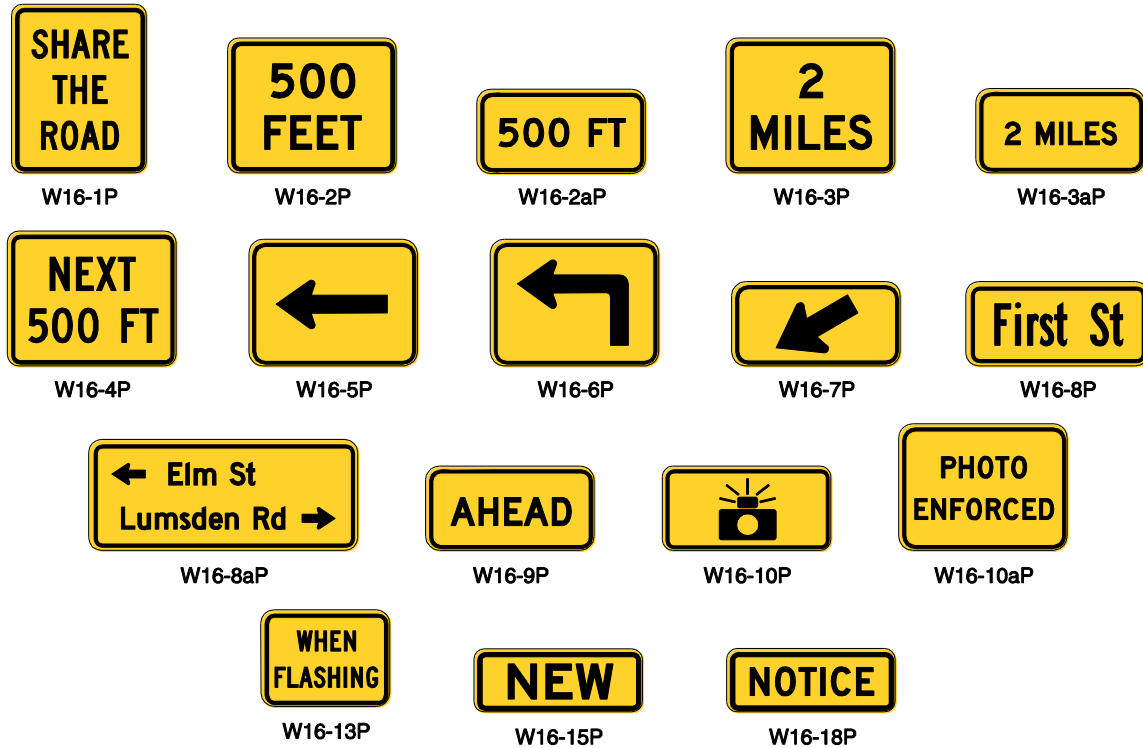
#### Support:

- 08 The Code of Virginia § 46.2-924 requires that drivers at crosswalks yield the right-of-way to pedestrians crossing the highway. The Standard statement in Section 2B.11 of the National MUTCD permits the use of the Stop Here for Pedestrians (R1-5b and R1-5c) signs only if state law specifically requires the driver to stop for a pedestrian in a crosswalk. As the Code of Virginia does not require a driver to stop, the R1-5b and R1-5c signs cannot be utilized.

#### Option:

- 09 The crossing location identified by a W11-2, W11-6, W11-7, or W11-9 sign may be defined with crosswalk markings (see [Section 3B.18 of this Supplement](#)).



**Figure 2C-12. Supplemental Warning Plaques**

Note: The background color (yellow or fluorescent yellow-green) shall match the color of the warning sign that it supplements.

**Standard:**

- 10 The W11-2 and W11-9 signs and their related supplemental plaques shall have a fluorescent yellow-green background with a black legend and border.

**Guidance:**

- 11 ~~When a fluorescent yellow-green background is used, a systematic approach featuring one background color within a zone or area should be used. The mixing of standard yellow and fluorescent yellow-green backgrounds within a selected site area should be avoided.~~

**Option:**

- 12 A Warning Beacon (see Section 4L.03 of the MUTCD) may be used with any Non-Vehicular Warning sign to indicate specific periods when the condition or activity is present or is likely to be present, or to provide enhanced sign conspicuity.
- 13 A supplemental WHEN FLASHING (W16-13P) plaque (see Figure 2C-12) may be used with any Non-Vehicular Warning sign that is supplemented with a Warning Beacon to indicate specific periods when the condition or activity is present or is likely to be present.



## Section 2C.51 Playground Sign (W15-1)

Option:

- 01 The Playground (W15-1) sign (see [Figure 2C-11\(VA\) in this Supplement](#)) may be used to give advance warning of a designated children's playground that is located adjacent to the road.

**Standard:**

- 02 **The Playground (W15-1) sign shall have a fluorescent yellow-green background with a black legend and border.**

*Guidance:*

- 03 *If the access to the playground area requires a roadway crossing, the application of crosswalk pavement markings (see [Section 3B.18 of this Supplement](#)) and Non-Vehicular Warning signs (see [Section 2C.50 of this Supplement](#)) should be considered.*



## Section 2C.63 Object Marker Design and Placement Height

Support:

- 01 Type 1, 2, and 3 object markers are used to mark obstructions within or adjacent to the roadway. Type 4 object markers are used to mark the end of a roadway.

**Standard:**

- 02 **When used, object markers (see [Figure 2C-13](#)) shall not have a border and shall consist of an arrangement of one or more of the following types:**

**Type 1**—a diamond-shaped sign, at least 18 inches on a side, consisting of either a yellow (OM1-1) or black (OM1-2) sign with nine yellow retroreflective devices, each with a minimum diameter of 3 inches, mounted symmetrically on the sign, or an all-yellow retroreflective sign (OM1-3).

**Type 2**—either a marker (OM2-1V or OM2-1H) consisting of three yellow retroreflective devices, each with a minimum diameter of 3 inches, arranged either horizontally or vertically on a white sign measuring at least 6 x 12 inches; or an all-yellow horizontal or vertical retroreflective sign (OM2-2V or OM2-2H), measuring at least 6 x 12 inches.

**Type 3**—a striped marker, 12 x 36 inches, consisting of a vertical rectangle with alternating black and retroreflective yellow stripes sloping downward at an angle of 45 degrees toward the side of the obstruction on which traffic is to pass. The minimum width of the yellow and black stripes shall be 3 inches.

**Type 4**—a diamond-shaped sign, at least 18 inches on a side, consisting of either a red (OM4-1) or black (OM4-2) sign with nine red retroreflective devices, each with a minimum diameter of 3 inches, mounted symmetrically on the sign, or an all-red retroreflective sign (OM4-3).

Support:

- 03 A better appearance can be achieved if the black stripes are wider than the yellow stripes.

- 04 Type 3 object markers with stripes that begin at the upper right side and slope downward to the lower left side are designated as right object markers (OM3-R). Object markers with stripes that begin at the upper left side and slope downward to the lower right side are designated as left object markers (OM3-L).

*Guidance:*

- 05 *When used for marking obstructions within the roadway or obstructions that are 8 feet or less from the shoulder or curb, the minimum mounting height, measured from the bottom of the object marker to the elevation of the near edge of the traveled way, should be 4 feet.*
- 06 *When used to mark obstructions more than 8 feet from the shoulder or curb, the clearance from the ground to the bottom of the object marker should be at least 4 feet.*

*Option:*

- 07 Larger and/or wider Type 3 Object Markers (OM3) may be utilized when engineering judgment determines a need for enhanced marking of an obstruction.

*Guidance*

- 08 *The larger OM3 Object Markers may be up to 30 inches wide and 30 inches tall.*
- 09 *Object markers should not present a vertical or horizontal clearance obstacle for pedestrians.*

*Option:*

- 10 When object markers or markings are applied to an obstruction that by its nature requires a lower or higher mounting, the vertical mounting height may vary according to need.

*Support:*

- 11 **Section 9B.26 of the MUTCD** contains information regarding the use of object markers on shared-use paths.



## **Section 2C.V1 Watch For Children (W15-V1)**

*Support:*

- 01 In accordance with the Code of Virginia § 33.1-201.2, a county may request that VDOT install and maintain the Watch for Children (W15-V1) sign (see Figure 2C-11(VA) in this Supplement). This sign can be used in residential areas on VDOT-maintained secondary routes to alert motorists that children may be at play in the vicinity.

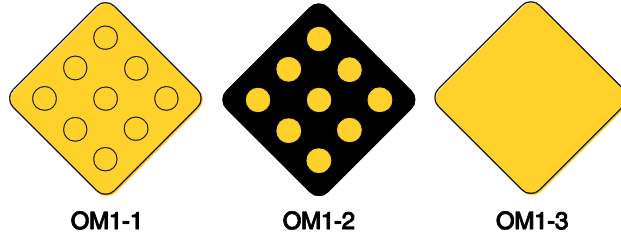
**Standard:**

- 02 **The WATCH FOR CHILDREN (W15-V1) sign shall have a fluorescent yellow-green background with a black legend and border.**
- 03 **The WATCH FOR CHILDREN (W15-V1) sign shall only be installed through the established request process described below.**

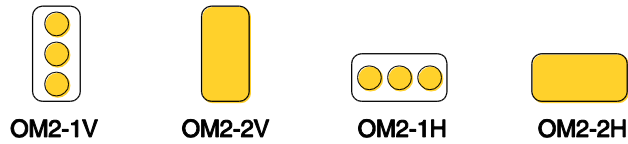


## Figure 2C-13 Object Markers

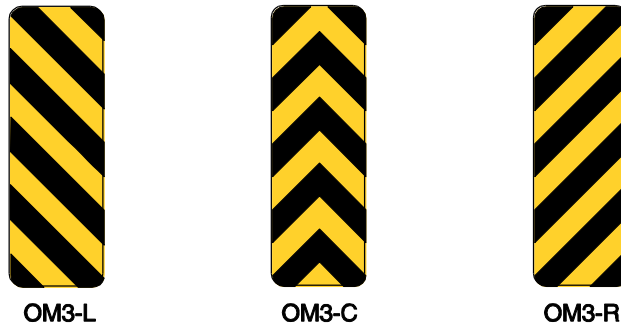
### Type 1 Object Markers (obstructions within the roadway)



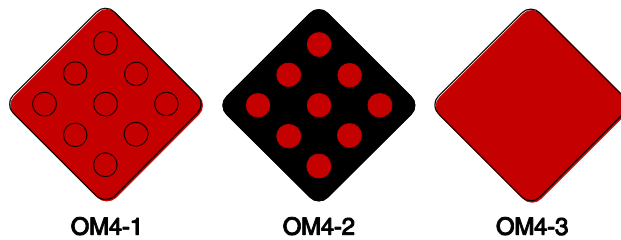
### Type 2 Object Markers (obstructions adjacent to the roadway)



### Type 3 Object Markers (obstructions adjacent to or within the roadway)



### Type 4 Object Markers (end of roadway)



**Support:**

- 04 Procedures for requesting the Watch for Children (W15-V1) sign, funding guidelines, and engineering requirements are defined in Traffic Engineering Division Memorandum, “Watch for Children Signs” on the VDOT website (see Appendix A of this Supplement).

**Section 2C.V2 STEEP GRADE AHEAD Plaque****Option:**

- 01 A STEEP GRADE AHEAD (W7-VP1) plaque may be utilized in conjunction with the COMMERCIAL VEHICLES EXCEPT BUSES USE RIGHT LANE WHEN OPERATED AT XX MPH OR BELOW (R4-V1) sign or the TRUCKS AND COMBINATION VEHICLES USE RIGHT LANE WHEN OPERATED BELOW XX MPH (R4-V4) sign (see Section 2B.V7 of this Supplement) to warn drivers that an uphill grade may affect heavy vehicle speeds.

**Standard:**

- 02 **When used, a STEEP GRADE AHEAD (W7-VP1) plaque (see Figure 2B-V7 V8\* in this Supplement) shall be placed above an R4-V1 or R4-V4 sign.**

# CHAPTER 2D. GUIDE SIGNS—CONVENTIONAL ROADS

## Section 2D.04 Size of Signs

### Standard:

- 01 Except as provided in [Section 2A.11 of this Supplement](#), the sizes of conventional road guide signs that have standardized designs shall be as shown in [Table 2D-1\(VA\) in this Supplement](#).

### Support:

- 02 [Section 2A.11 of this Supplement](#) contains information regarding the applicability of the various columns in [Table 2D-1\(VA\) in this Supplement](#).

### Option:

- 03 Signs larger than those shown in [Table 2D-1\(VA\) in this Supplement](#) may be used (see [Section 2A.11 of this Supplement](#)).

### Support:

- 04 For other guide signs, the legends are so variable that a standardized design or size is not appropriate. The sign size is determined primarily by the length of the message, and the size of lettering and spacing necessary for proper legibility.

### Option:

- 05 Reduced letter height, reduced interline spacing, and reduced edge spacing may be used on guide signs if sign size must be limited by factors such as lane width or vertical or lateral clearance.

### Guidance:

- 06 *Reduced spacing between the letters or words on a line of legend should not be used as a means of reducing the overall size of a guide sign, except where determined necessary by engineering judgment to meet unusual lateral space constraints. In such cases, the legibility distance of the sign legend should be the primary consideration in determining whether to reduce the spacing between the letters or the words or between the words and the sign border, or to reduce the letter height.*
- 07 *When a reduction in the prescribed size is necessary, the design used should be as similar as possible to the design for the standard size.*

**Table 2D-1(VA). Conventional Road Guide Sign Sizes**

Sign	Sign Designation	Section	Conventional Road	Minimum	Oversized
Interstate Route Sign (1 or 2 digits)	M1-1	2D.11	24 x 24	24 x 24	36 x 36
Interstate Route Sign (3 digits)	M1-1	2D.11	30 x 24	30 x 24	45 x 36
Off-Interstate Route Sign (1 or 2 digits)	M1-2,3	2D.11	24 x 24	24 x 24	36 x 36
Off-Interstate Route Sign (3 digits)	M1-2,3	2D.11	30 x 24	30 x 24	45 x 36
U.S. Route Sign (1 or 2 digits)	M1-4	2D.11	24 x 24	24 x 24	36 x 36
U.S. Route Sign (3 digits)	M1-4	2D.11	30 x 24	30 x 24	45 x 36
State Route Sign (1 or 2 digits)	M1-5	2D.11	24 x 24	24 x 24	36 x 36
State Route Sign (3 digits)	M1-5	2D.11	30 x 24	30 x 24	45 x 36
Virginia Primary Route Sign (1 or 2 digits)	M1-V1a, V1b	2D.11 2E.27	36 x 36	24 x 24	48 x 48
Virginia Primary Route Sign (3 digits)	M1-V1c, V1d	2D.11 2E.27	45 x 36	30 x 24	60 x 48
Virginia Circular Secondary Route Sign (3 or more digits)	M1-V2a, V2b, V2c, V2d, V2e, V2f	2D.11 2E.27	36 x 36	24 x 24	48 x 48
County Route Sign (1, 2, or 3 digits)	M1-6	2D.11	24 x 24	24 x 24	36 x 36
Forest Route (1, 2, or 3 digits)	M1-7	2D.11	24 x 24	18 x 18	36 x 36
Junction	M2-1	2D.13	21 x 15	21 x 15	30 x 21
Combination Junction (2 route signs)	M2-2	2D.14	60 x 48*	—	—
Cardinal Direction	M3-1,2,3,4	2D.15	24 x 12	24 x 12	36 x 18
Alternate	M4-1,1a	2D.17	24 x 12	24 x 12	36 x 18
By-Pass	M4-2	2D.18	24 x 12	24 x 12	36 x 18
Business	M4-3	2D.19	24 x 12	24 x 12	36 x 18
Truck	M4-4	2D.20	24 x 12	24 x 12	36 x 18
To	M4-5	2D.21	24 x 12	24 x 12	36 x 18
End	M4-6	2D.22	24 x 12	24 x 12	36 x 18
Temporary	M4-7,7a	2D.24	24 x 12	24 x 12	36 x 18
Begin	M4-14	2D.23	24 x 12	24 x 12	36 x 18
Advance Turn Arrow	M5-1,2,3	2D.26	21 x 15	21 x 15	—
Lane Designation	M5-4,5,6	2D.27	24 x 18	24 x 18	36 x 24
Directional Arrow	M6-1,2,2a,3,4,5,6,7	2D.28	21 x 15	21 x 15	30 x 21
Destination (1 line)	D1-1	2D.37	Varies x 18	Varies x 18	—
Destination and Distance (1 line)	D1-1a	2D.37	Varies x 18	Varies x 18	—
Circular Intersection Destination (1 line)	D1-1d	2D.38	Varies x 18	Varies x 18	—
Circular Intersection Departure Guide	D1-1e	2D.38	Varies x 42*	—	—
Destination (2 lines)	D1-2	2D.37	Varies x 30	Varies x 30	—
Destination and Distance (2 lines)	D1-2a	2D.37	Varies x 30	Varies x 30	—
Circular Intersection Destination (2 lines)	D1-2d	2D.38	Varies x 30	Varies x 30	—

Sign	Sign Designation	Section	Conventional Road	Minimum	Oversized
Destination (3 lines)	D1-3	2D.37	Varies x 42	Varies x 42	—
Destination and Distance (3 lines)	D1-3a	2D.37	Varies x 42	Varies x 42	—
Circular Intersection Destination (3 lines)	D1-3d	2D.38	Varies x 42	Varies x 42	—
Distance (1 line)	D2-1	2D.41	Varies x 18	Varies x 18	—
Distance (2 lines)	D2-2	2D.41	Varies x 30	Varies x 30	—
Distance (3 lines)	D2-3	2D.41	Varies x 42	Varies x 42	—
Street Name (1 line)	D3-1,1a	2D.43	Varies x 12	Varies x 8	Varies x 18
Overhead Street Name Sign	D3-V1	2D.43	Varies x 24	—	—
Overhead Street Name Sign with Multiple Street Names	D3-V1a	2D.43	Varies x 42	—	—
Overhead Street Name Sign with Block Numbers	D3-V1b	2D.43	Varies x 36	—	—
Advance Street Name (2 lines)	D3-2	2D.44	Varies x 30*	—	—
Advance Street Name Sign with Multiple Street Names	D3-V2	2D.44	Varies x 48*	—	—
Advance Street Name (3 lines)	D3-2	2D.44	Varies x 42*	—	—
Advance Street Name (4 lines)	D3-2	2D.44	Varies x 60*	—	—
Parking Area	D4-1	2D.47	30 x 24	18 x 15	—
Park - Ride	D4-2	2D.48	30 x 36	24 x 30	36 x 48
National Scenic Byways	D6-4	2D.55	24 x 24	24 x 24	—
National Scenic Byways	D6-4a	2D.55	24 x 12	24 x 12	—
Weigh Station XX Miles	D8-1	2D.49	78 x 60	60 x 48	96 x 72
Weigh Station Next Right	D8-2	2D.49	84 x 72	66 x 54	108 x 90
Weigh Station (with arrow)	D8-3	2D.49	66 x 60	48 x 42	84 x 78
Crossover	D13-1,2	2D.54	60 x 30	60 x 30	78 x 42
Freeway Entrance	D13-3	2D.46	48 x 30	48 x 30	—
Freeway Entrance (with arrow)	D13-3a	2D.46	48 x 42	48 x 42	—
Combination Lane Use / Destination	D15-1	2D.33	Varies x 96	Varies x 96	—
Next Truck Lane XX Miles	D17-1	2D.51	42 x 48	42 x 48	60 x 66
Truck Lane XX Miles	D17-2	2D.51	42 x 42	42 x 42	60 x 54
Slow Vehicle Turn-Out XX Miles	D17-7	2D.52	72 x 42	72 x 42	96 x 54
<b>Virginia Specific Signs</b>					
Virginia Rectangular Secondary Route Sign (3 digits) - Two Arrows	M1-V3aB	2D.11	24 x 9	—	—
Virginia Rectangular Secondary Route Sign (3 digits) - Left Arrow	M1-V3aL	2D.11	24 x 9	—	—
Virginia Rectangular Secondary Route Sign (3 digits) - Right Arrow	M1-V3aR	2D.11	24 x 9	—	—
Virginia Rectangular Secondary Route Sign (4 digits) - Two Arrows	M1-V3bB	2D.11	24 x 9	—	—
Virginia Rectangular Secondary Route Sign (4 digits) - Left Arrow	M1-V3bL	2D.11	24 x 9	—	—

Sign	Sign Designation	Section	Conventional Road	Minimum	Oversized
Virginia Rectangular Secondary Route Sign (4 digits) - Right Arrow	M1-V3bR	2D.11	24 x 9	—	—
Virginia Rectangular Secondary Route Sign (5 digits) - Two Arrows	M1-V3cB	2D.11	24 x 9	—	—
Virginia Rectangular Secondary Route Sign (5 digits) - Left Arrow	M1-V3cL	2D.11	24 x 9	—	—
Virginia Rectangular Secondary Route Sign (5 digits) - Right Arrow	M1-V3cR	2D.11	24 x 9	—	—
OLD	M4-V7	2D.V1	18 x 6	—	24 x 12
Through Route Block Numbers	D3-V3	2D.43	24 x 30	—	—
ENTERING (plaque)	D6-VP1	2D.V2	24 x 9	—	—
LEAVING (plaque)	D6-VP2	2D.V2	24 x 9	—	—
VIRGINIA BYWAY	D6-V1	2D.V2	24 X 24	—	—

\*The size shown is for a typical sign. The size should be determined based on the amount of legend required for the sign.

- Notes: 1. Larger signs may be used when appropriate  
2. Dimensions in inches are shown as width x height

## Section 2D.05 Lettering Style

### Standard:

- 01 The design of upper-case letters, lower-case letters, numerals, route shields, and spacing shall be as provided in the "Standard Highway Signs and Markings" book (see [Section 1A.11 of this Supplement](#)), and the "Virginia Standard Highway Signs" book (see [Appendix A of this Supplement](#) for link).
- 02 The lettering for names of places, streets, and highways on conventional road guide signs shall be a combination of lower-case letters with initial upper-case letters (see [Section 2A.13 of this Supplement](#)). The nominal loop height of the lower-case letters shall be 3/4 the height of the initial upper-case letter. When a mixed-case legend letter height is specified referring only to the initial upper-case letter, the height of the lower-case letters that follow shall be determined by this proportion. When the height of a lower-case letter is referenced, the reference is made to the nominal loop height and the height of the initial upper-case letter shall also be determined by this proportion.
- 03 All other word legends on conventional road guide signs shall be in upper-case letters.
- 04 The unique letter forms for each of the Standard Alphabet series shall not be stretched, compressed, warped, or otherwise manipulated. Modifications to the length of a word for a given letter height and series shall be accomplished only by the methods described in [Section 2D.04 of this Supplement](#).

## Section 2D.09 Numbered Highway Systems

Support:

- 01 The purpose of numbering and signing highway systems is to identify routes and facilitate travel.
- 02 The Interstate and United States (U.S.) highway systems are numbered by the American Association of State Highway and Transportation Officials (AASHTO) upon recommendations of the State highway organizations because the respective States own these systems. State and county road systems are numbered by the appropriate authorities.
- 03 The basic policy for numbering the Interstate and U.S. highway systems is contained in the following Purpose and Policy statements published by AASHTO (see [Page i of the MUTCD](#) for AASHTO's address):
  - A. "Establishment and Development of United States Numbered Highways," and
  - B. "Establishment of a Marking System of the Routes Comprising the National System of Interstate and Defense Highways."

*Guidance:*

- 04 *The principles of these policies should be followed in establishing the highway systems described in Paragraph 2 and any other systems, with effective coordination between adjacent jurisdictions. Care should be taken to avoid the use of numbers or other designations that have been assigned to Interstate, U.S., or State routes in the same geographic area. Overlapping numbered routes should be kept to a minimum.*

**Standard:**

- 05 **Route systems shall be given preference in this order: Interstate, United States, Primary State, and Secondary State. The preference shall be given by installing the highest-priority legend on the top or the left of the sign.**

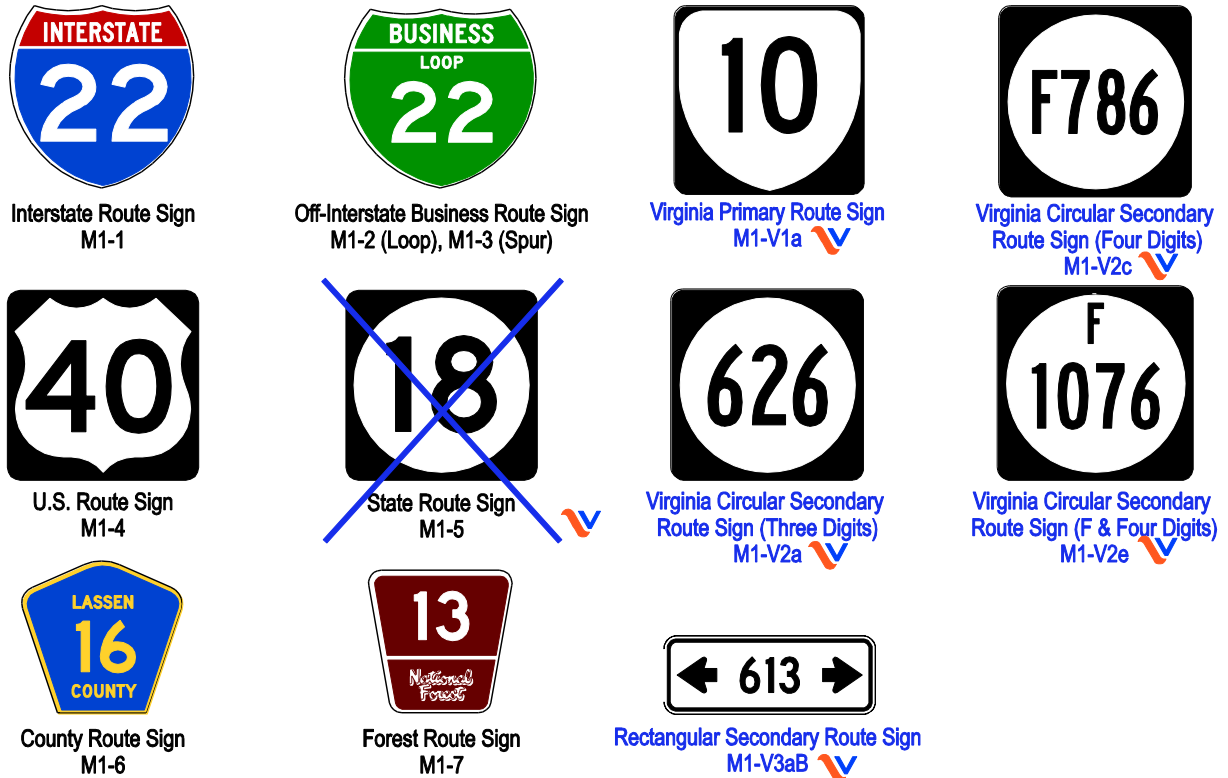
Support:

- 06 [Section 2D.53 of this Supplement](#) contains information regarding the signing of unnumbered highways to enhance route guidance and facilitate travel.

## Section 2D.11 Design of Route Signs

**Standard:**

- 01 The "Standard Highway Signs and Markings" book (see [Section 1A.11 of this Supplement](#)) shall be used for designing **Interstate and U.S.** route signs. Other route sign designs shall be established by the authority having jurisdiction.
- 02 Interstate Route signs (see [Figure 2D-3\(VA\) in this Supplement](#)) shall consist of a cutout shield, with the route number in white letters on a blue background, the word INTERSTATE in white upper-case letters on a red background, and a white border. This sign shall be used on all Interstate routes and in connection with route sign assemblies on intersecting highways.

**Figure 2D-3(VA). Route Signs**

- 03 **Interstate Route signs shall not contain the State name.**
- 04 **A 24 x 24-inch minimum sign size shall be used for Interstate route numbers with one or two digits, and a 30 x 24-inch minimum sign size shall be used for Interstate route numbers having three digits.**
- 05 **Off-Interstate Business Route signs (see [Figure 2D-3\(VA\)](#) in this Supplement) shall consist of a cutout shield carrying the number of the connecting Interstate route and the words BUSINESS and either LOOP or SPUR in upper-case letters. The legend and border shall be white on a green background, and the shield shall be the same shape and dimensions as the Interstate Route sign. In no instance shall the word INTERSTATE appear on the Off-Interstate Business Route sign.**
- Option:
- 06 The Off-Interstate Business Route sign may be used on a major highway that is not a part of the Interstate system, but one that serves the business area of a city from an interchange on the system.
- 07 When used on a green guide sign, a white square or rectangle may be placed behind the shield to improve contrast.
- Standard:**
- 08 **U.S. Route signs (see [Figure 2D-3\(VA\)](#) in this Supplement) shall consist of black numerals on a white shield surrounded by a rectangular black background without a**



**border. This sign shall be used on all U.S. routes and in connection with route sign assemblies on intersecting highways.**

- 09 **A 24 x 24-inch minimum sign size shall be used for U.S. route numbers with one or two digits, and a 30 x 24-inch minimum sign size shall be used for U.S. route numbers having three digits.**
- 10 **State Route signs shall be designed by the individual State highway agencies.**

**Standard:**

- 11 **Virginia Primary Route (M1-V1) and Virginia Circular Secondary Route (M1-V2) signs (see Figure 2D-3(VA) in this Supplement) shall be approximately the same size as the U.S. Route sign. Both signs shall also be similar to the U.S. Route sign by containing black numerals on a white area surrounded by a rectangular black background without a border.**
- 12 **Where U.S. Route, Virginia Primary Route, or Virginia Circular Secondary Route signs are used as components of guide signs, only the distinctive shape of the shield itself and the route numerals within shall be used. The rectangular background upon which the distinctive shape of the shield is mounted, such as the black area around the outside of the shields on the M1-4, M1-V1, and M1-V2 signs, shall not be included on the guide sign. Where U.S. Route, Virginia Primary Route, or Virginia Circular Secondary Route signs are used as components of other signs of non-contrasting background colors, the rectangular background shall be used so that recognition of the distinctive shape of the shield can be maintained.**
- 13 **If county road authorities elect to establish and identify a special system of important county roads, a statewide policy for such signing shall be established that includes a uniform numbering system to uniquely identify each route. The County Route (M1-6) sign (see Figure 2D-3(VA) in this Supplement) shall consist of a pentagon shape with a yellow county name and route number and border on a blue background. County Route signs displaying two digits or the equivalent (letter and numeral, or two letters) shall be a minimum size of 18 x 18 inches; those carrying three digits or the equivalent shall be a minimum size of 24 x 24 inches.**
- 14 **If a jurisdiction uses letters instead of numbers to identify routes, all references to numbered routes in this Chapter shall be interpreted to also include lettered routes.**

*Guidance:*

- 15 *If used with other route signs in common assemblies, the County Route sign should be of a size compatible with that of the other route signs.*

*Option:*

- 16 *When used on a green guide sign, a yellow square or rectangle may be placed behind the County Route sign to improve contrast.*

**Standard:**

- 17 **Route signs (see Figure 2D-3(VA) in this Supplement) for park and forest roads shall be designed with adequate distinctiveness and legibility and of a size compatible with other route signs used in common assemblies.**



## Section 2D.12 Design of Route Sign Auxiliaries

### Standard:

- 01 **Route sign auxiliaries carrying word legends, except the JCT sign, shall have a standard size of 24 x 12 inches. Those carrying arrow symbols, or the JCT sign, shall have a standard size of 21 x 15 inches. All route sign auxiliaries shall match the color combination of the route sign that they supplement.**

### Guidance:

- 02 *With route signs of larger heights, auxiliary signs should be suitably enlarged, but not such that they exceed the width of the route sign.*
- 03 *The background, legend, and border of a route sign auxiliary should have the same colors as those of the route sign with which the auxiliary is mounted in a route sign assembly (see [Section 2D.29 of this Supplement](#)). For a route sign design that uses multiple background colors, such as the Interstate route sign, the background color of the corresponding auxiliary should be that of the background area on which the route number is placed on the route sign.*

### Option:

- 04 A route sign and any auxiliary signs used with it may be combined on a single sign as a guide sign.

### Guidance:

- 05 *If a route sign and its auxiliary signs are combined to form a single guide sign, the background color of the sign should be green and the design should comply with the basic principles for the design of guide signs. [Route signs and their auxiliary signs should not be combined on a single sign with a black background.](#)*

### Standard:

- 06 **If a route sign and its auxiliary signs are combined on a single sign with a green background, the auxiliary messages shall be white legends placed directly on the green background. Auxiliary signs shall not be mounted directly to a guide sign or other type of sign.**

### Support:

- 07 Chapter 2F contains information regarding auxiliary signs for toll highways.

## Section 2D.29 Route Sign Assemblies

### Standard:

- 01 **A Route Sign assembly shall consist of a route sign and auxiliary signs that further identify the route and indicate the direction. Route Sign assemblies shall be installed on all approaches to numbered routes that intersect with other numbered routes.**
- 02 **Where two or more routes follow the same section of highway, the route signs for Interstate, U.S., State, and county routes shall be mounted in that order from the left in horizontal arrangements and from the top in vertical arrangements. Subject to this**



**order of precedence, route signs for lower-numbered routes shall be placed at the left or top.**

- 03 **Within groups of assemblies, information for routes intersecting from the left shall be mounted at the left in horizontal arrangements and at the top or center of vertical arrangements. Similarly, information for routes intersecting from the right shall be at the right or bottom, and for straight-through routes at the center in horizontal arrangements or top in vertical arrangements.**

- 04 **Route Sign assemblies shall be mounted in accordance with the general specifications for signs (Chapter 2A), with the lowest sign in the assembly at the height prescribed for single signs.**

*Guidance:*

- 05 *Assemblies for two or more routes, or for different directions on the same route, should be mounted in groups on a common support.*

*Option:*

- 06 Route Sign assemblies may be installed on the approaches to numbered routes on unnumbered roads and streets that carry an appreciable amount of traffic destined for the numbered route.

- 07 The diagrammatic route guide sign format, such as the D1-4 and D1-5 signs shown in Figure 2D-8 of the MUTCD, may be used on approaches to roundabouts.

- 08 If engineering judgment indicates that groups of assemblies that include overlapping routes or multiple turns might be confusing, route signs or auxiliary signs may be omitted or combined, provided that clear directions are given to road users.

*Support:*

- 09 [Figure 2D-6\(VA\) in this Supplement](#) shows typical placements of route signs.

*Guidance:*

- 10 *Virginia Circular Secondary Route (M1-V2a, M1-V2c, and M1-V2e) signs (see Figure 2D-3(VA) in this Supplement) should be installed on the more heavily traveled Secondary routes and on those of importance to through traffic. This sign should also be installed on Primary routes in advance of intersections with heavily traveled Secondary routes.*

*Option:*

- 11 On Secondary routes which are Frontage roads with a four digit route number, the letter “F” may appear above the route number within the M1-V2e sign (see Figure 2D-3(VA) in this Supplement).

**Standard:**

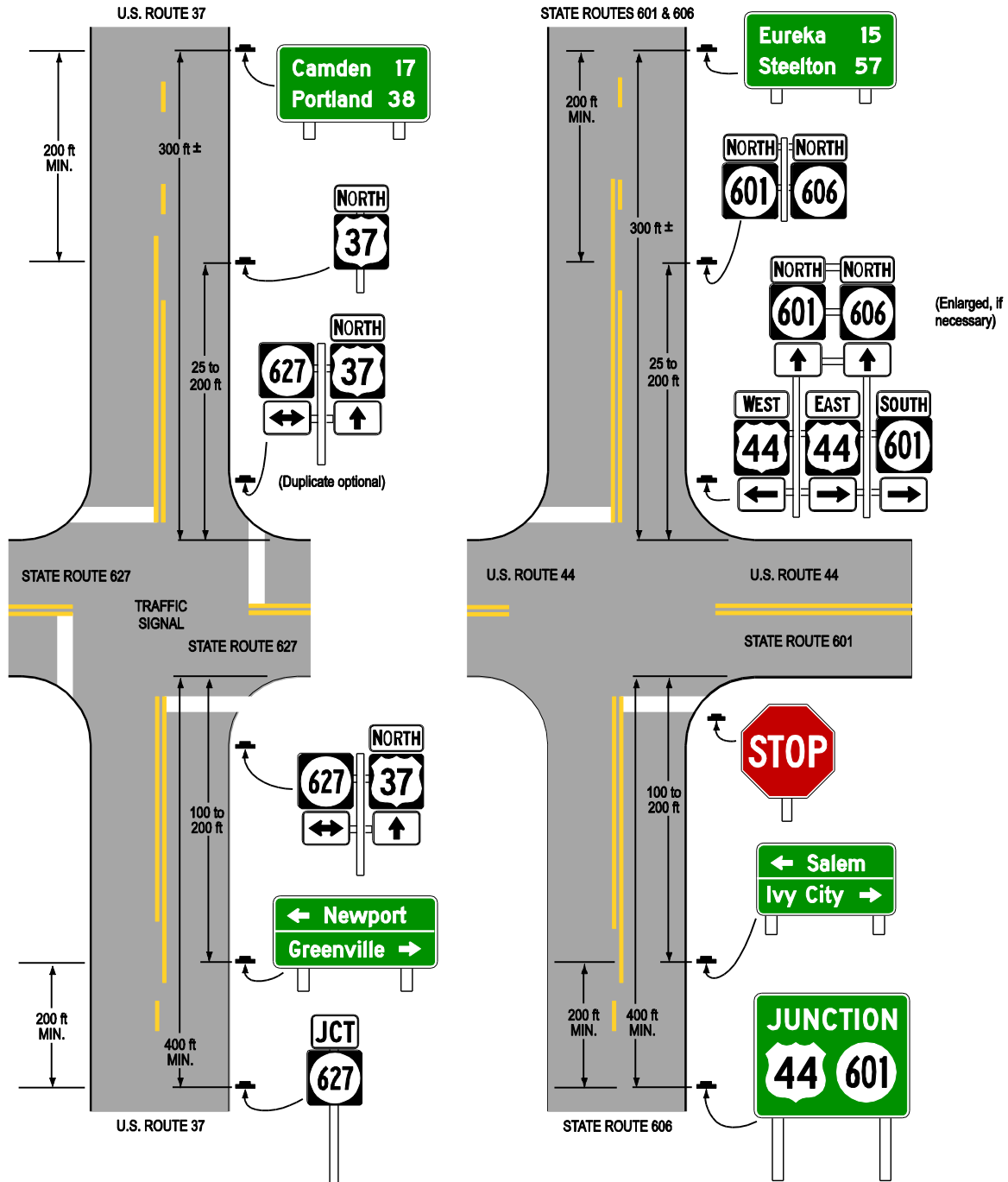
- 12 **Rectangular Secondary Route (M1-V3) signs (see Figure 2D-3(VA) in this Supplement) shall be installed at intersections between Secondary Routes or at intersections between a Primary Route and a Secondary Route where the M1-V2 sign is not needed.**

*Option:*

- 13 Rectangular Secondary Route signs may be installed below a STOP (R1-1) or YIELD (R1-2) sign at a Secondary route intersection.

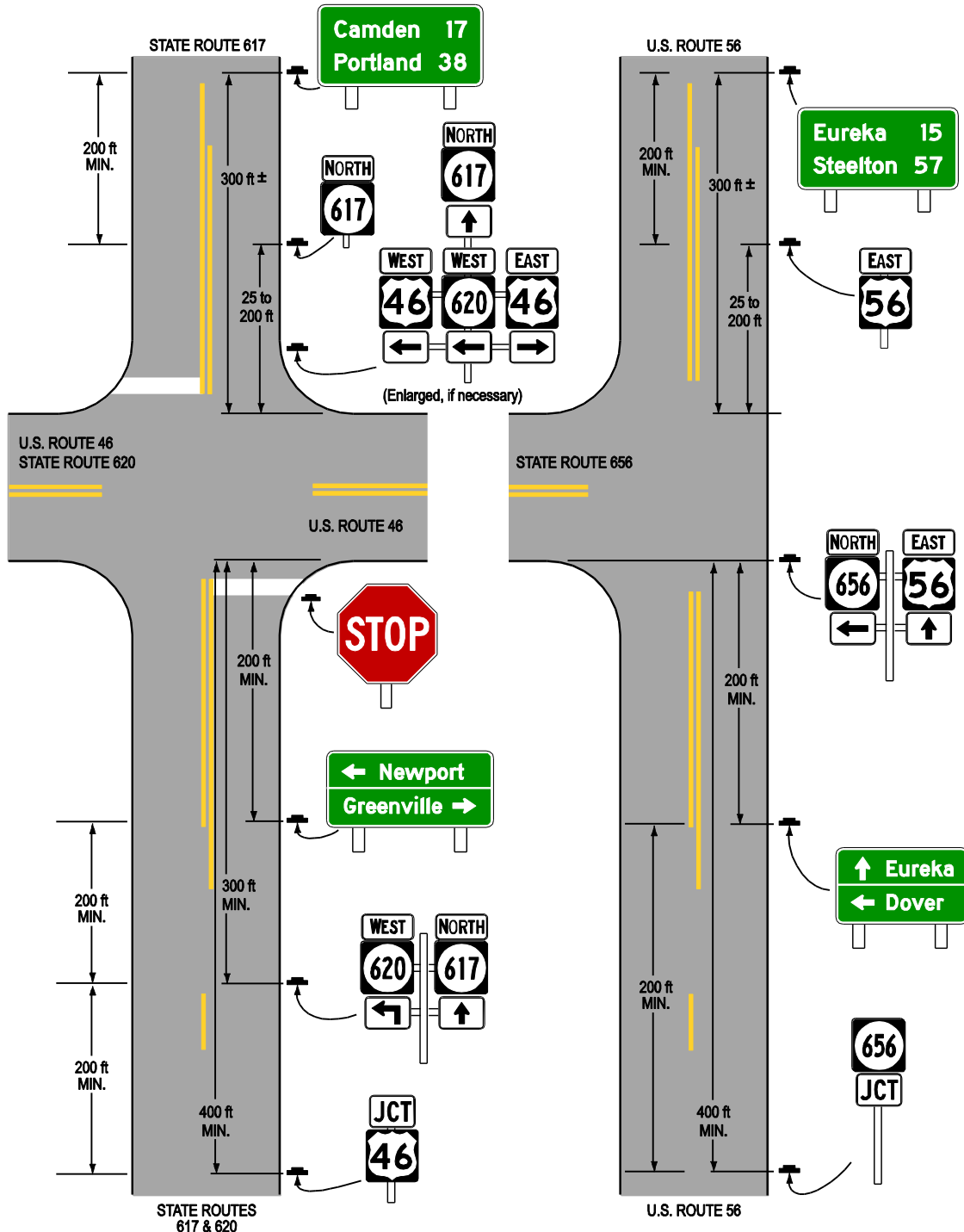


**Figure 2D-6(VA). Illustration of Directional Assemblies and Other Route Signs (for One Direction of Travel Only)  
(Sheet 1 of 4)**



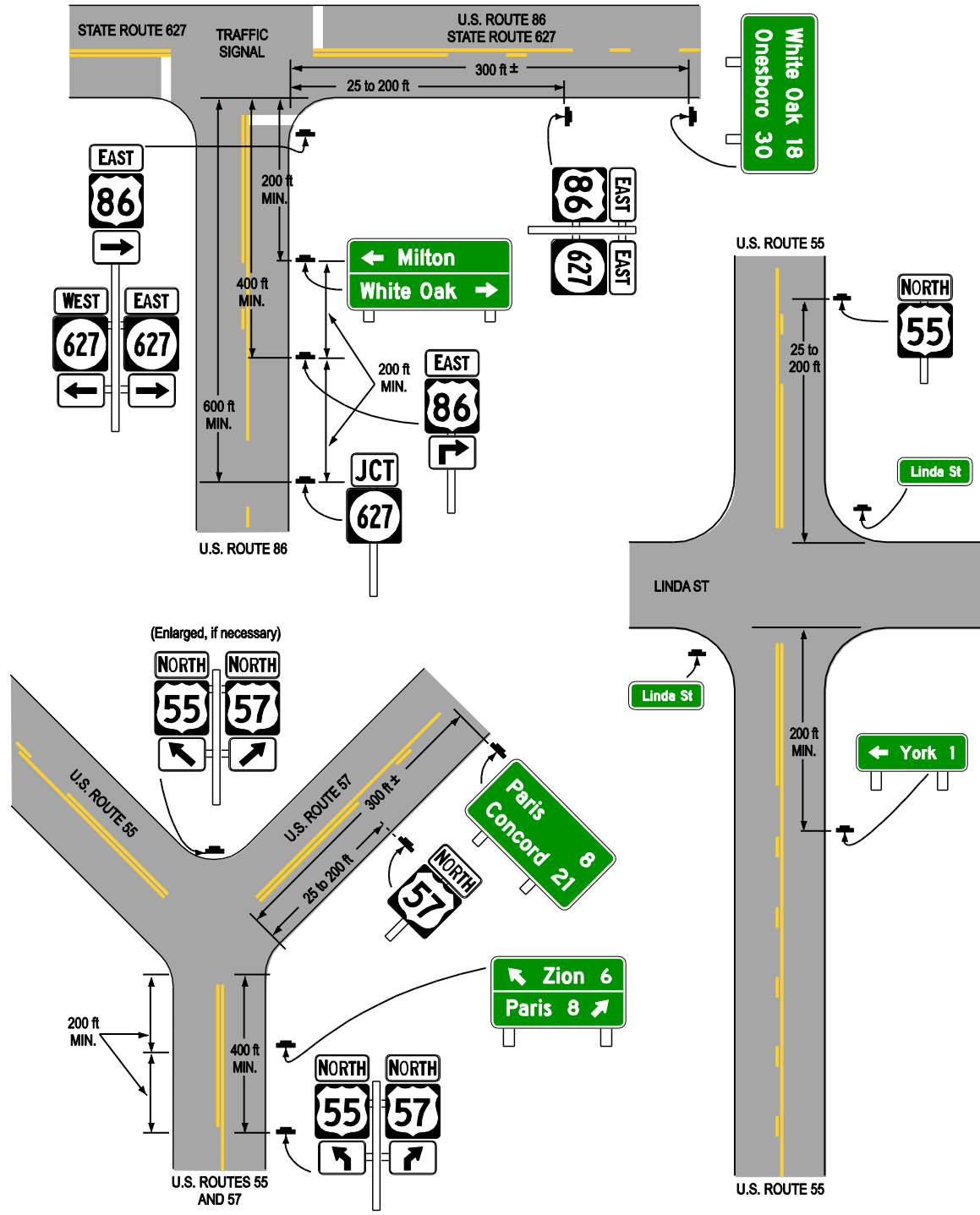
Note: The spacings shown on this figure are for rural intersections.  
See Sections 2D.29, 2D.30, 2D.32, 2D.34, 2D.40, and 2D.42 for low-speed and/or urban conditions.

**Figure 2D-6(VA). Illustration of Directional Assemblies and Other Route Signs (for One Direction of Travel Only)  
(Sheet 2 of 4)**



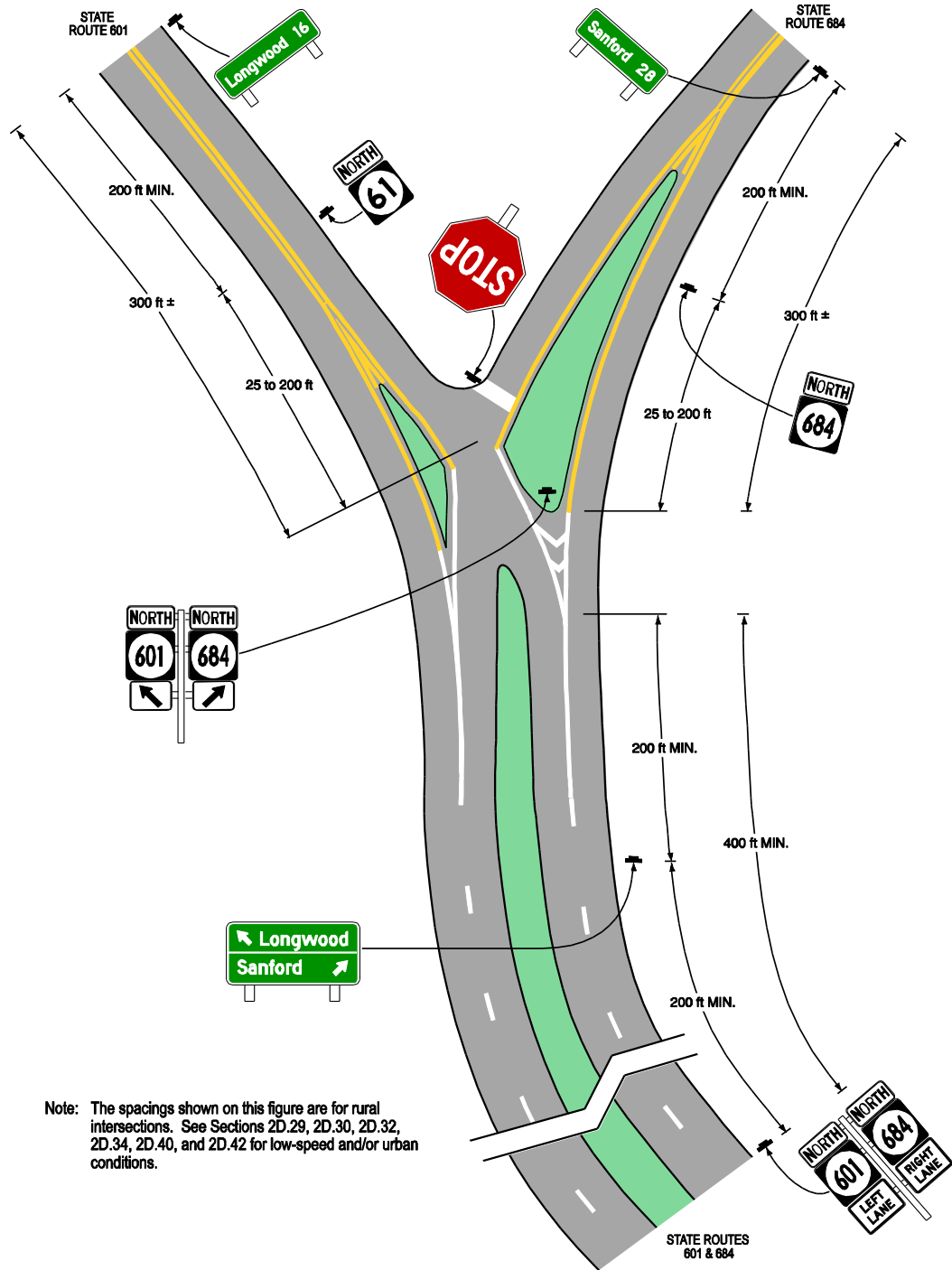
Note: The spacings shown on this figure are for rural intersections.  
See Sections 2D.29, 2D.30, 2D.32, 2D.34, 2D.40, and 2D.42 for low-speed and/or urban conditions.

**Figure 2D-6(VA). Illustration of Directional Assemblies and Other Route Signs (for One Direction of Travel Only)  
(Sheet 3 of 4)**



Note: The spacings shown on this figure are for rural intersections.  
See Sections 2D.29, 2D.30, 2D.32, 2D.34, 2D.40, and 2D.42 for low-speed and/or urban conditions.

**Figure 2D-6(VA). Illustration of Directional Assemblies and Other Route Signs (for One Direction of Travel Only)  
(Sheet 4 of 4)**



Note: The spacings shown on this figure are for rural intersections. See Sections 2D.29, 2D.30, 2D.32, 2D.34, 2D.40, and 2D.42 for low-speed and/or urban conditions.

**Standard:**

- 14 **Rectangular Secondary Route signs shall not be used to substitute for U.S. and Primary Route shields.**

**Section 2D.42 Location of Distance Signs****Standard:**

- 01 **Distance signs shall be installed on Primary routes at locations meeting one of three criteria:**
- A. Leaving municipalities**
  - B. Just beyond interchanges and intersections with Interstates and other Primary routes in rural areas**
  - C. In rural areas where Criteria A and B do not apply at intervals of not less than 10 miles.**

*Guidance:*

- 02 *Distance signs should be placed just outside the municipal limits or at the edge of the built-up area if it extends beyond the limits.*
- 03 *Where overlapping routes separate a short distance from the municipal limits, the Distance sign at the municipal limits should be omitted. The Distance sign should be installed approximately 300 feet beyond the separation of the two routes.*
- 04 *Where, just outside of an incorporated municipality, two routes are concurrent and continue concurrently to the next incorporated municipality, the top name on the Distance sign should be that of the place where the routes separate; the bottom name should be that of the city to which the greater part of the through traffic is destined.*

**Support:**

- 05 **Figure 2D-6(VA) in this Supplement** shows typical placements of Distance signs.

**Section 2D.43 Street Name Signs (D3-1, D3-1a, D3-V1, D3-V1a, D3-V1b, or D3-V3)***Guidance:*

- 01 *Street Name (D3-1 or D3-1a, D3-V1, D3-V1a, D3-V1b) signs (see Figure 2D-10(VA) in this Supplement) should be installed in urban areas at all street intersections regardless of other route signs that might be present and should be installed in rural areas to identify important roads that are not otherwise signed.*

**Option:**

- 02 For streets that are part of a U.S., State, or county numbered route, a D3-1a **post-mounted** Street Name sign (see Figure 2D-10(VA) in this Supplement) that incorporates a route shield may be used to assist road users who might not otherwise be able to associate the name of the street with the route number.



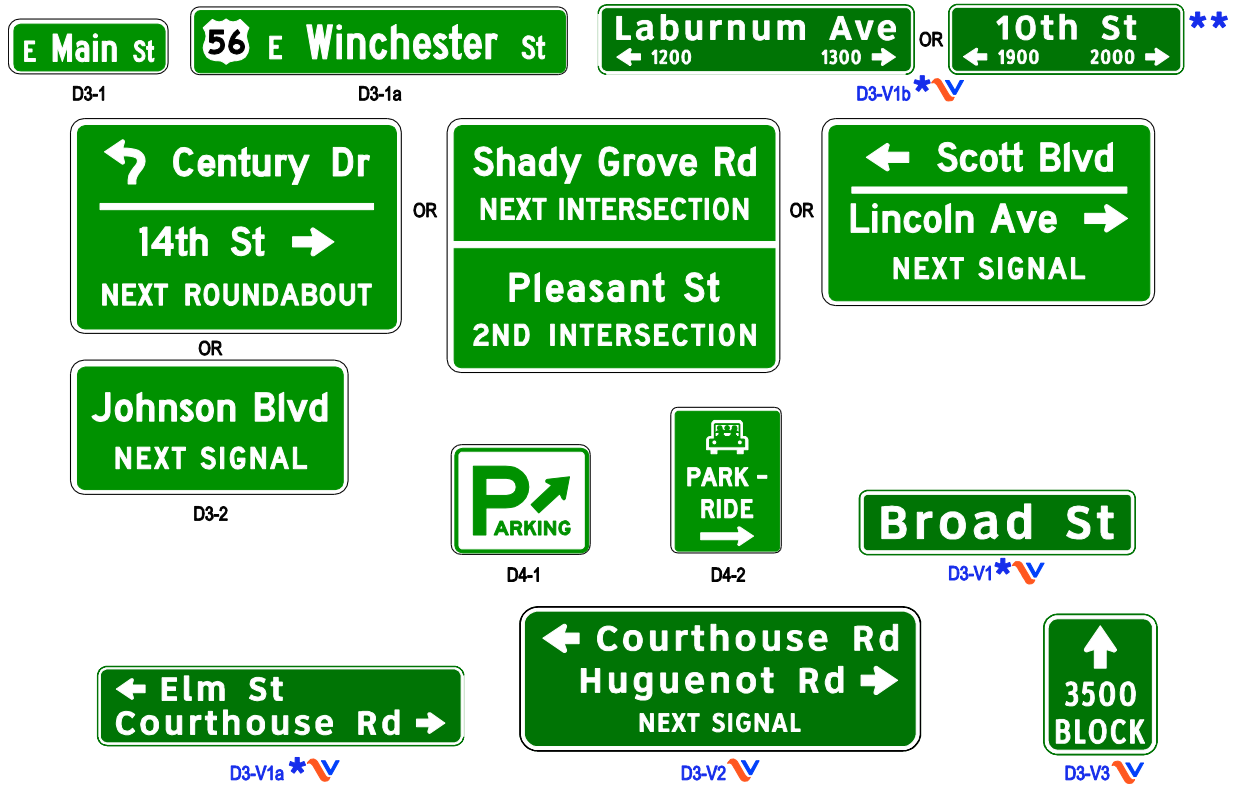
**Standard:**

- 03 **The lettering for names of streets and highways on Street Name (D3-1 or D3-1a, D3-V1, D3-V1a, D3-V1b)\* signs shall be composed of a combination of lower-case letters with initial upper-case letters (see Section 2A.13 of this Supplement).**
- 04 **Except as provided in Paragraph 6 below, lettering on post-mounted Street Name (D3-1 or D3-1a)\* signs shall be composed of initial upper-case letters at least 6 inches in height and lower-case letters at least 4.5 inches in height.**
- 05 **On multi-lane streets with speed limits greater than 40 mph, the lettering on post-mounted Street Name (D3-1 or D3-1a)\* signs shall be composed of initial upper-case letters at least 8 inches in height and lower-case letters at least 6 inches in height.**

**Option:**

- 06 For local roads with speed limits of 25 mph or less, the lettering on post-mounted Street Name (D3-1 or D3-1a)\* signs may be composed of initial upper-case letters at least 4 inches in height and lower-case letters at least 3 inches in height. Line of sight visibility and lighting may be considered when selecting the letter height and placement. At local road locations where engineering judgment determines constrained conditions exist, such as where a replacement Street Name (D3-1 or D3-1a, D3-V1, D3-V1a, D3-V1b) sign panel is being retrofitted onto an existing sign support with structural, space or height limitations, the Street Name (D3-1 or D3-1a, D3-V1, D3-V1a, D3-V1b) sign panel height may be reduced to 6 inches.\*

**Figure 2D-10 (VA). Street Name and Parking Signs**



\* These signs shall be mounted overhead.

\*\* Alternate layout of D3-V1b sign for short street names.

**Guidance:**

- 07 If overhead Street Name signs (D3-V1, D3-V1a, or\* D3-V1b) are used, the lettering should be composed of initial upper-case letters at least 12 inches in height and lower-case letters at least 9 inches in height. Initial upper-case letter heights of less than 12 inches and lower-case letter heights of less than 9 inches should only be used where a sign is being retrofitted onto an existing structure that cannot support a sign large enough to accommodate those letter heights. In such cases, the letter height should be the maximum practical size that can be accommodated on the structure. The designer should use an iterative process and first attempt to utilize an initial upper-case letter height of 11 inches, and then if that sign cannot be accommodated, an initial upper-case letter height of 10 inches should be used, and so on until a letter size that can be accommodated is found.\*

**Support:**

- 08 The minimum letter heights for Street Name (D3-1 or D3-1a, D3-V1, D3-V1a, D3-V1b)\* signs are summarized in Table 2D-2 (VA) in this Supplement\*.

## Option:

- 09 Supplementary lettering to indicate the type of street (such as Street, Avenue, or Road) or the section of the city (such as NW) on the D3-1 and D3-1a **post-mounted street name Street Name\*** signs may be in smaller lettering, composed of initial upper-case letters at least 3 inches in height and lower-case letters at least 2.25 inches in height. Conventional abbreviations (see [Section 1A.15 of the MUTCD](#)) may be used except for the street name itself.
- 10 A pictograph (see definition in [Section 1A.13 of this Supplement](#)) may be used on a D3-1 **post-mounted street name** sign.
- 11 Block numbers may be used on street name signs to guide motorists to specific points along a route.

**Standard:**

- 12 **If used on overhead street name Street Name\* signs (D3-V1, D3-V1a, or D3-V1b)\*, block numbers and arrows shall appear on a line below the street name.**

## Option:

- 13 Through Route Block Number (D3-V3) signs (see Figure 2D-10(VA) in this Supplement) may be used at signalized intersections displaying the block number of the through route immediately beyond the signalized intersection.

**Standard:**

- 14 **Pictographs shall not be displayed on D3-1a post-mounted street name Street Name\* signs or Advance Street Name (D3-2 or D3-V2) signs (see [Section 2D.44 of this Supplement](#)).**
- 15 **If a pictograph is used on a D3-1 post-mounted street name Street Name\* sign, the height and width of the pictograph shall not exceed the upper-case letter height of the principal legend of the sign.**

*Guidance:*

- 16 *The pictograph should be positioned to the left of the street name.*

**Standard:**

- 17 **The Street Name sign (D3-1 or D3-1a, D3-V1, D3-V1a, D3-V1b)\* signs shall be retroreflective or illuminated to show the same shape and similar color both day and night. The color of the legend (and border, if used) shall contrast with the background color of the sign.**

## Option:

- 18 The border may be omitted from a Street Name (D3-1 or D3-1a, D3-V1, D3-V1a, D3-V1b)\* sign.



**Table 2D-2(VA). Recommended\* Minimum Letter Heights on Street Name Signs**

Type of Mounting	Type of Street or Highway	Speed Limit	Recommended Minimum Letter Height	
			Initial Upper-Case	Lower-Case
Overhead	All types	All speed limits	12 inches	9 inches
Post-mounted	Multi-lane	More than 40 mph	8 inches	6 inches
Post-mounted	Multi-lane	40 mph or less	6 inches	4.5 inches
Post-mounted	2-lane	All speed limits	6 inches*	4.5 inches*

\* On local two-lane streets with speed limits of 25 mph or less, 4-inch initial upper-case letters with 3-inch lower-case letters may be used.



*Guidance:*

- 19 *The background color for **street name Street Name (D3-1 or D3-1a, D3-V1, D3-V1a, D3-V1b)\*** signs should be green.*

*Option:*

- 20 *An alternative background color other than the normal guide sign color of green may be used for **post-mounted Street Name (D3-1 or D3-1a) or overhead Street Name (D3-V1, D3-V1a, or\* D3-V1b)** signs where the highway agency determines this is necessary to assist road users in determining jurisdictional authority for roads.*

**Standard:**

- 21 **Alternative background colors shall not be used for Advance Street Name (D3-2 or D3-V2) signs (see Section 2D.44 of this Supplement).**
- 22 **The only acceptable alternative background colors for **post-mounted Street Name (D3-1 or D3-1a) or overhead **street name Street Name\*** (D3-V1, D3-V1a, D3-V1b)** signs shall be blue, brown, or white. Regardless of whether green, blue, or brown is used as the background color for **post-mounted Street Name (D3-1 or D3-1a)** signs, the legend (and border, if used) shall be white. For Street Name **(D3-1 or D3-1a, D3-V1, D3-V1a, D3-V1b)\*** signs that use a white background, the legend (and border, if used) shall be black.**

*Guidance:*

- 23 *An alternative background color for Street Name signs, if used, should be applied to the **post-mounted Street Name (D3-1 or D3-1a) signs and overhead **street name Street Name\*** (D3-V1, D3-V1a, or D3-V1b)** signs on all roadways within a particular jurisdiction.*
- 24 *If a white background color is used, the sign legend should be black series E modified font.*
- 25 *In business or commercial areas and on principal arterials, Street Name **(D3-1 or D3-1a, D3-V1, D3-V1a, D3-V1b)\*** signs should be placed at least on diagonally opposite corners. In residential areas, at least one Street Name **(D3-1 or D3-1a, D3-V1, D3-V1a, D3-V1b)\*** sign should be mounted at each intersection. Signs naming both streets should be*

*installed at each intersection. They should be mounted with their faces parallel to the streets they name.*

Option:

- 26 **Post-mounted Street Name signs (D3-1 or D3-1a)** may also be placed above a regulatory or STOP or YIELD sign with no required vertical separation.

Guidance:

- 27 *In urban or suburban areas, especially where Advance Street Name (D3-2 or D3-V2)\* signs for signalized and other major intersections are not used, the use of overhead Street Name signs (D3-V1, D3-V1a, D3-V1b) should be strongly considered.*

Option:

- 28 At intersection crossroads where the same road has two different street names for each direction of travel, both street names may be displayed on the same sign along with directional arrows.

Support:

- 29 Information regarding the use of street names on supplemental plaques for use with intersection-related warning signs is contained in [Section 2C.58 of the MUTCD](#).

**Standard:**

- 30 **Overhead (D3-V1, D3-V1a, or\* D3-V1b) or post-mounted Street Name\* (D3-1, or\* D3-1a) street name\* signs shall be used at all signalized intersections.**

- 31 **Except as provided in Paragraphs 32 and 33 below, overhead street name signs Street Name\* (D3-V1, D3-V1a, or\* D3-V1b) signs\* shall be installed at all signalized intersections with mast arms.**

- 32 ~~If physical restrictions prohibit the use of overhead street name signs (D3-V1, D3-V1a, D3-V1b), then street name signs shall be installed on the signal pole. In such instances, the size of the sign shall be equivalent to an overhead street name sign.\*~~

- 32 **If physical restrictions prohibit the use of overhead Street Name (D3-V1, D3-V1a, or D3-V1b) signs, then Street Name (D3-1 or D3-1a, D3-V1, D3-V1a, D3-V1b) signs shall be installed on the signal pole. In such instances, the size of the sign shall be equivalent to an overhead Street Name (D3-V1, D3-V1a, or D3-V1b) sign.\***

Guidance:

- 33 *If the crossing street is the entrance to a shopping center that has no official street name, it should be signed with a generic message such as “Shopping Center Entrance.”*



## **Section 2D.44 Advance Street Name Signs (D3-2 & D3-V2)**

Support:

- 01 Advance Street Name (D3-2 and D3-V2) signs (see [Figure 2D-10\(VA\)](#) in this Supplement) identify an upcoming intersection. Although this is often the next intersection, it could also be several intersections away in cases where the next signalized intersection is referenced.

**Standard:**

- 02 **Advance Street Name (D3-2 and D3-V2) signs, if used, shall supplement rather than be used instead of the Street Name (D3-1) signs at the intersection.**

**Option:**

- 03 Advance Street Name (D3-2 and D3-V2) signs may be installed in advance of signalized or unsignalized intersections to provide road users with advance information to identify the name(s) of the next intersecting street to prepare for crossing traffic and to facilitate timely deceleration and/or lane changing in preparation for a turn.

**Guidance:**

- 04 *On arterial highways in rural areas, Advance Street Name signs should be used in advance of all signalized intersections and in advance of all intersections with exclusive turn lanes.*

- 05 *In urban and suburban areas, Advance Street Name signs should be used in advance of all signalized intersections on principal arterials (see FHWA functional classification, link provided in Appendix A of this Supplement). At a minimum, Advance Street Name signs should be used on streets with three or more approach lanes and posted speed limit of 45 mph or greater.*

**Option:**

- 06 *In both cases, Advance Street Name Signs may be omitted where signalized intersections are so closely spaced that advance placement of the signs is impractical.*
- 07 *The heights of the letters on Advance Street Name signs should be the same as those used for the Street Name signs at the intersection requiring advance signing (see Section 2D.43 of this Supplement).*

**Standard:**

- 08 **If used, Advance Street Name signs shall have a white legend and border on a green background.**
- 09 **If used, Advance Street Name signs shall provide the name(s) of the intersecting street(s) on the top line(s) of the legend and the distance to the intersecting streets or messages such as NEXT SIGNAL, NEXT INTERSECTION, NEXT ROUNDABOUT, or directional arrow(s) on the bottom line of the legend.**
- 10 **Pictographs shall not be displayed on Advance Street Name signs.**

**Option:**

- 11 Directional arrow(s) may be placed to the right or left of the street name or message such as NEXT SIGNAL, as appropriate, rather than on the bottom line of the legend. Curved-stem arrows may be used on Advance Street Name signs on approaches to circular intersections.
- 12 For intersecting crossroads where the same road has a different street name for each direction of travel, the different street names may be displayed on the same Advance Street Name sign along with directional arrows.



- 13 In advance of two closely-spaced intersections where it is not practical to install separate Advance Street Name signs, the Advance Street Name sign may include the street names for both intersections along with appropriate supplemental legends for both street names, such as NEXT INTERSECTION, 2ND INTERSECTION, or NEXT LEFT and NEXT RIGHT, or directional arrows.

*Guidance:*

- 14 *If two street names are used on the Advance Street Name sign, the street names should be displayed in the following order:*



- A. *For a single intersection where the same road has a different street name for each direction of travel, the name of the street to the left should be displayed above the name of the street to the right. The two road names should not be divided by a horizontal line (see Figure 2D-10(VA) in this Supplement); or*
- B. *For two closely-spaced intersections, the name of the first street encountered should be displayed above the name of the second street encountered, and the arrow associated with the second street encountered should be an advance arrow, such as the arrow shown on the W16-6P arrow plaque (see Figure 2C-12).*

*Option:*

- 15 An Advance Street Name (W16-8P or W16-8aP) plaque (see [Section 2C.58 of the MUTCD](#)) with black legend on a yellow background, installed supplemental to an Intersection (W2 series) or Advance Traffic Control (W3 series) warning sign may be used instead of an Advance Street Name guide sign.

## **Section 2D.53 Signing of Named Highways**

*Option:*

- 01 Guide signs may contain street or highway names if the purpose is to enhance driver communication and guidance; however, they are to be considered as supplemental information to route numbers.

**Standard:**

- 02 **Highway names shall not replace official numeral designations.**
- 03 **Memorial names (see [Section 2M.10 of this Supplement](#)) shall not appear on supplemental signs or on any other information sign on or along the highway or its intersecting routes.**
- 04 **The use of route signs shall be restricted to signs officially used for guidance of traffic in accordance with this Manual and the "Purpose and Policy" statement of the American Association of State Highway and Transportation Officials that applies to Interstate and U.S. numbered routes (see Page I of the [MUTCD](#) for AASHTO's address).**

**Option:**

- 05 Unnumbered routes having major importance to proper guidance of traffic may be signed if carried out in accordance with the aforementioned policies. For unnumbered highways, a name to enhance route guidance may be used where the name is applied consistently throughout its length.

**Guidance:**

- 06 *Only one name should be used to identify any highway, whether numbered or unnumbered.*

**Standard:**

- 07 **Signs for named highways shall be consistent in design with signs for memorial highways and facilities (see Section 2M.10 of this Supplement).**



## **Section 2D.V1 OLD (M4-V7) Auxiliary Signs**

**Option:**

- 01 The OLD (M4-V1V7\*) auxiliary sign (see Figure 2D-4(VA) in this Supplement) may be used where a route has been transferred from its original number and/or system.

**Standard:**

- 02 **If used, the OLD auxiliary sign shall be used in combination with the old and new route numbers for a period of one year.**



## **Section 2D.V2 VIRGINIA BYWAY (D6-V1) Signs**

**Support:**

- 01 The Virginia Byway program identifies road corridors containing aesthetic or cultural value near areas of historical, natural or recreational significance. The Commonwealth Transportation Board (CTB) designates select roadway corridors as Virginia Byways, and signs are installed at various points along these corridors (see Figure 2D-V1 in this Supplement).
- 02 Additional information about the Virginia Byway program can be accessed at VDOT's web site, see the Appendix of this Supplement for the web address.

**Standard:**

- 03 **VIRGINIA BYWAY (D6-V1) signs (see Figure 2D-V1 in this Supplement) shall be installed at the termini of a route or sections thereof which have been designated as Virginia Byways by the CTB. Additionally, Virginia Byway signs shall be installed between the termini at intervals of approximately 5 miles.**
- 04 **ENTERING (D6-VP1) and LEAVING (D6-VP2) plaques shall be placed above the VIRGINIA BYWAY signs at the beginning and end, respectively, of the designated Virginia Byway route or segment.**



Figure 2D-4(VA). Route Sign Auxiliaries

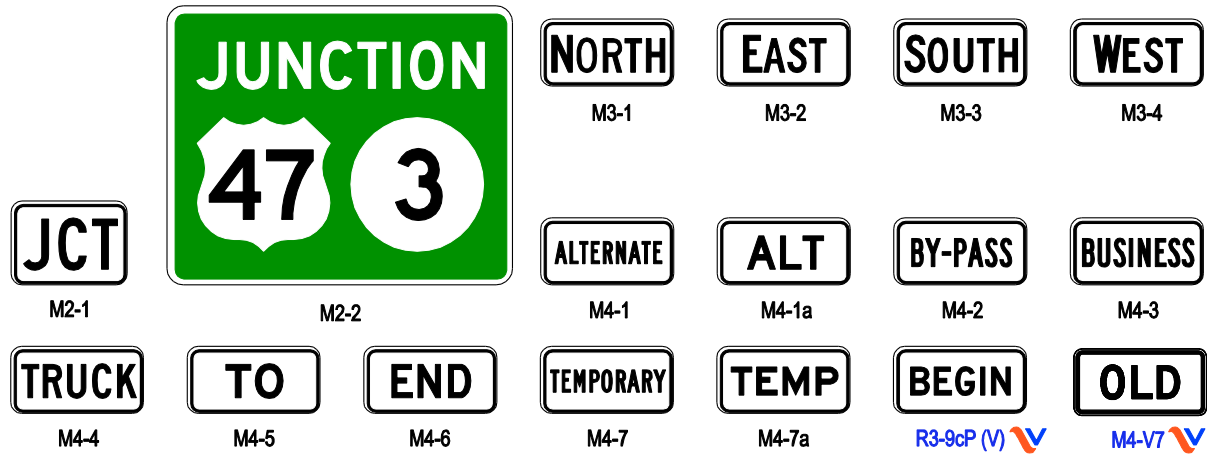
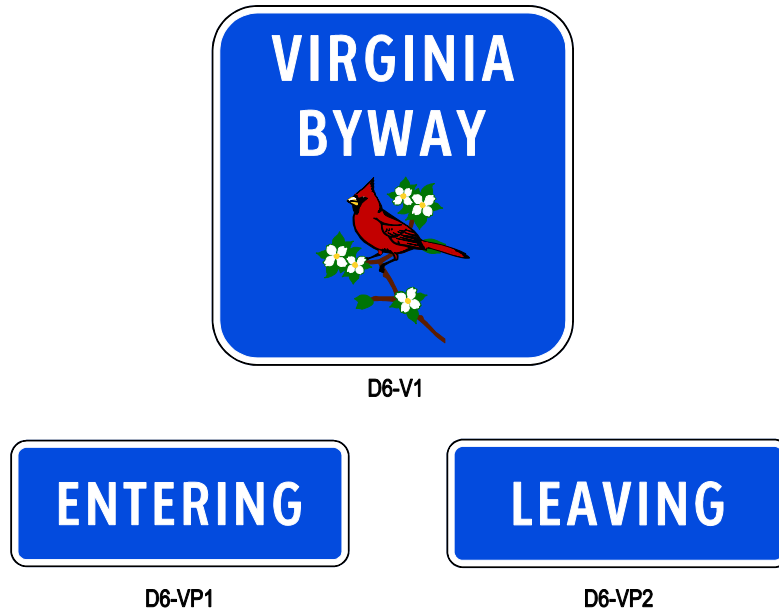


Figure 2D-V1. Virginia Byway Signs



# CHAPTER 2E. GUIDE SIGNS—FREEWAYS AND EXPRESSWAYS

## Section 2E.14 Size and Style of Letters and Signs

### Standard:

- 01 Except as provided in [Section 2A.11 of this Supplement](#), the sizes of freeway and expressway guide signs that have standardized designs shall be as shown in [Table 2E-1\(VA\) in this Supplement](#).

### Support:

- 02 [Section 2A.11 of this Supplement](#) contains information regarding the applicability of the various columns in [Table 2E-1\(VA\) in this Supplement](#).

### Option:

- 03 Signs larger than those shown in [Table 2E-1\(VA\) in this Supplement](#) may be used (see [Section 2A.11 of this Supplement](#)).

### Standard:

- 04 For all freeway and expressway signs that do not have a standardized design, the message dimensions shall be determined first, and the outside sign dimensions secondarily. Word messages in the legend of expressway guide signs shall be in letters at least 8 inches high. Larger lettering shall be used for major guide signs at or in advance of interchanges and for all overhead signs. Minimum numeral and letter sizes for expressway guide signs according to interchange classification, type of sign, and component of sign legend shall be as shown in Tables 2E-2 and 2E-3. Minimum numeral and letter sizes for freeway guide signs according to interchange classification, type of sign, and component of sign legend shall be as shown in Tables 2E-4 and 2E-5. All names of places, streets, and highways on freeway and expressway guide signs shall be composed of lower-case letters with initial upper-case letters. ~~The letters and the numerals used shall be Clearview 5-W or 5-W-R (see Section 2A.13 of this Supplement).~~\*



- 05 ~~When the Standard Highway Sign Alphabets are used, the~~\* nominal loop height of the lower-case letters shall be 3/4 of the height of the initial upper-case letter (see Paragraph 2 of [Section 2D.05 of this Supplement](#) for additional information on the specification of letter heights). ~~Other word legends shall be composed of upper-case letters.~~ ~~When the Standard Highway Sign Alphabets are used,~~\* Interline and edge spacing shall be as provided in [Section 2E.15 of the MUTCD](#).

- 06 ~~Clearview lettering shall not be used for all upper-case sign legends.~~\*

- 07 ~~When Clearview lettering is used, the Federal Highway Administration's "Design and Use Policy for the Clearview Alphabet" (a link to this document is provided in Appendix A) shall be used when designing the sign legends.~~\*

**Option:**

- 08 The lower-case letters and initial upper-case letters used for names of places, streets, and highways on positive contrast guide signs (e.g. white legend on a green, blue, or brown background) may use Clearview 5-W or 5-W-R (see Section 2A.13 of this Supplement and the Virginia Standard Highway Signs book).\*

**Support:**

- 09 Guidance on when to use Clearview 5-W and Clearview 5-W-R can be found in the “Virginia Standard Highway Signs” book (see Appendix A for link).\*

**Standard:**

- 10 The letters and numerals used for other sign legend, including all legend on signs that are not positive contrast guide signs, shall be the Standard Highway Sign Alphabets of the “Standard Highway Signs and Markings” book (see Section 1A.11 of this Supplement).\*

**Option:**

- 11 In accordance with Section 2D.50 of the National MUTCD, a lettering style other than the Standard Highway Sign Alphabets may be used on community wayfinding signs if an engineering study determines that the legibility and recognition values for the chosen lettering style meet or exceed the values for the Standard Highway Sign Alphabets for the same legend height and stroke width.\*

- 0512 **Lettering size on freeway and expressway signs shall be the same for both rural and urban conditions.**

**Support:**

- 0613 Sign size is determined primarily in terms of the length of the message and the size of the lettering necessary for proper legibility. Letter style and height, and arrow design have been standardized for freeway and expressway signs to assure uniform and effective application.

## Table 2E-1(VA). Freeway or Expressway Guide Sign and Plaque Sizes

Sign or Plaque	Sign Designation	Section	Minimum Size
Exit Number (plaque)			
1-, 2-Digit Exit Number	E1-5P	2E.31	114 x 30
3-Digit Exit Number	E1-5P	2E.31	132 x 30
1-, 2-Digit Exit Number (with single letter suffix)	E1-5P	2E.31	138 x 30
3-Digit Exit Number (with single letter suffix)	E1-5P	2E.31	156 x 30
1-, 2-Digit Exit Number (with dual letter suffix)	E1-5P	2E.31	168 x 30
3-Digit Exit Number (with dual letter suffix)	E1-5P	2E.31	186 x 30
Left (plaque)	E1-5aP	2E.33	72 x 30
Left Exit Number (plaque)			
1-, 2-Digit Exit Number	E1-5bP	2E.31	114 x 54
3-Digit Exit Number	E1-5bP	2E.31	132 x 54
1-, 2-Digit Exit Number (with single letter suffix)	E1-5bP	2E.31	138 x 54
3-Digit Exit Number (with single letter suffix)	E1-5bP	2E.31	156 x 54
1-, 2-Digit Exit Number (with dual letter suffix)	E1-5bP	2E.31	168 x 54
3-Digit Exit Number (with dual letter suffix)	E1-5bP	2E.31	186 x 54
Next Exit XX Miles (1 line)	—	2E.34	Varies x 24
Next Exit XX Miles (2 lines)	—	2E.34	Varies x 36
Exit Gore (no exit number)	E5-1	2E.37	72 x 60
Exit Gore (with exit number)			
1-, 2-Digit Exit Number	E5-1a	2E.37	78 x 60
3-Digit Exit Number	E5-1a	2E.37	96 x 60
1-Digit Exit Number (with single letter suffix)	E5-1a	2E.37	90 x 60
2-Digit Exit Number (with single letter suffix)	E5-1a	2E.37	108 x 60
3-Digit Exit Number (with single letter suffix)	E5-1a	2E.37	126 x 60
1-Digit Exit Number (with dual letter suffix)	E5-1a	2E.37	120 x 60
2-Digit Exit Number (with dual letter suffix)	E5-1a	2E.37	138 x 60
3-Digit Exit Number (with dual letter suffix)	E5-1a	2E.37	156 x 60
Exit Number (plaque)			
1-, 2-Digit Exit Number	E5-1bP	2E.37	42 x 30
3-Digit Exit Number	E5-1bP	2E.37	60 x 30
1-Digit Exit Number (with single letter suffix)	E5-1bP	2E.37	48 x 30
1-Digit Exit Number (with dual letter suffix)	E5-1bP	2E.37	72 x 30
2-Digit Exit Number (with single or dual letter suffix)	E5-1bP	2E.37	72 x 30
3-Digit Exit Number (with single or dual letter suffix)	E5-1bP	2E.37	72 x 30
Narrow Exit Gore	E5-1c	2E.37	60 x 90*
Pull-Through	E6-2	2E.12	Varies x 120*
Pull-Through	E6-2a	2E.12	Varies x 90*
Exit Only (with arrow)	E11-1,1d	2E.24	174** x 36
Exit	E11-1a	2E.24	66 x 18

Sign or Plaque	Sign Designation	Section	Minimum Size
Only	E11-1b	2E.24	66 x 18
Exit Only	E11-1c	2E.24	120 x 18
Exit Only (with two arrows)	E11-1e,1f	2E.24	222** x 36
Left	E11-2	2E.40	60 x 18
Exit Gore Advisory Speed (plaque)	E13-1P	2E.37	72 x 24
Exit Direction Advisory Speed	E13-2	2E.36	162 x 24
Interstate Route Sign (1 or 2 digits)	M1-1	2E.27	36 x 36
Interstate Route Sign (3 digits)	M1-1	2E.27	45 x 36
Off-Interstate Route Sign (1 or 2 digits)	M1-2,3	2E.27	36 x 36
Off-Interstate Route Sign (3 digits)	M1-2,3	2E.27	45 x 36
U.S. Route Sign (1 or 2 digits)	M1-4	2E.27	36 x 36
U.S. Route Sign (3 digits)	M1-4	2E.27	45 x 36
<del>State Route Sign (1 or 2 digits)</del>	<del>M1-5</del>	<del>2D.11</del>	<del>36 x 36</del>
<del>State Route Sign (3 digits)</del>	<del>M1-5</del>	<del>2D.11</del>	<del>45 x 36</del>
Virginia Primary Route Sign (1 or 2 digits)	M1-V1a, V1b	2D.11	36 x 36
Virginia Primary Route Sign (3 digits)	M1-V1c, V1d	2D.11	45 x 36
Virginia Circular Secondary Route Sign (3 or more digits)	M1-V2a, V2b, V2c, V2d, V2e, V2f	2D.11	36 x 36
County Route Sign (1, 2, or 3 digits)	M1-6	2D.11	36 x 36
Forest Route (1, 2, or 3 digits)	M1-7	2D.11	36 x 36
Eisenhower Interstate System	M1-10,10a	2E.28	36 x 36
Junction	M2-1	2D.13	30 x 21
Combination Junction (2 route signs)	M2-2	2D.14	60 x 48*
Cardinal Direction	M3-1,2,3,4	2D.15	36 x 18
Alternate	M4-1,1a	2D.17	36 x 18
By-Pass	M4-2	2D.18	36 x 18
Business	M4-3	2D.19	36 x 18
Truck	M4-4	2D.20	36 x 18
To	M4-5	2D.21	36 x 18
End	M4-6	2D.22	36 x 18
Temporary	M4-7,7a	2D.24	36 x 18
Begin	M4-14	2D.23	36 x 18
Advance Turn Arrow	M5-1,2,3	2D.26	30 x 21
Lane Designation	M5-4,5,6	2D.27	36 x 24
Directional Arrow	M6-1,2, 2a,3,4,5,6,7	2D.28	30 x 21
Destination (1 line)	D1-1	2D.37	Varies x 30
Destination and Distance (1 line)	D1-1a	2D.37	Varies x 30
Destination (2 lines)	D1-2	2D.37	Varies x 54
Destination and Distance (2 lines)	D1-2a	2D.37	Varies x 54
Destination (3 lines)	D1-3	2D.37	Varies x 72
Destination and Distance (3 lines)	D1-3a	2D.37	Varies x 72
Distance (1 line)	D2-1	2D.41	Varies x 30

Sign or Plaque	Sign Designation	Section	Minimum Size
Distance (2 lines)	D2-2	2D.41	Varies x 54
Distance (3 lines)	D2-3	2D.41	Varies x 72
Street Name	D3-1,1a	2D.43	Varies x 18
Advance Street Name (2 lines)	D3-2	2D.44	Varies x 42*
Advance Street Name (3 lines)	D3-2	2D.44	Varies x 66*
Advance Street Name (4 lines)	D3-2	2D.44	Varies x 84*
Park - Ride	D4-2	2D.48	36 x 48
National Scenic Byways	D6-4	2D.55	24 x 24
National Scenic Byways	D6-4a	2D.55	24 x 12
Weigh Station XX Miles	D8-1	2E.54	96 x 72 (F) 78 x 60 (E)
Weigh Station Next Right	D8-2	2E.54	108 x 90 (F) 84 x 72 (E)
Weigh Station (with arrow)	D8-3	2E.54	84 x 78 (F) 66 x 60 (E)
Crossover	D13-1,2	2D.54	78 x 42
Freeway Entrance	D13-3	2D.46	48 x 30
Freeway Entrance (with arrow)	D13-3a	2D.46	48 x 42
Combination Lane Use / Destination	D15-1	2D.33	Varies x 96
Next Truck Lane XX Miles	D17-1	2D.51	60 x 66
Truck Lane XX Miles	D17-2	2D.51	60 x 54
Slow Vehicle Turn-Out XX Miles	D17-7	2D.52	96 x 54

\* The size shown is for a typical sign as illustrated in the figures in Chapters 2D and 2E. The size should be determined based on the amount of legend required for the sign.

\*\* The width shown represents the minimum dimension. The width shall be increased as appropriate to match the width of the guide sign.

- Notes:
1. Larger signs may be used when appropriate
  2. Dimensions in inches are shown as width x height
  3. Where two sizes are shown, the larger size is for freeways (F) and the smaller size is for expressways (E)

**Table 2E-2. Minimum Letter and Numeral Sizes for Expressway Guide Signs According to Interchange Classification**

Type of Sign	Type of Interchange (see Section 2E.32 of the MUTCD)				Overhead
	Major		Intermediate	Minor	
	Category a	Category b			
<b>A. Advance Guide, Exit Direction, and Overhead Guide Signs</b>					
Exit Number Plaques					
Words	10	10	10	8	10
Numerals & Letters	15	15	15	12	15
Interstate Route Signs					
Numerals	18	—	—	—	18
1- or 2-Digit Shields	36 x 36	—	—	—	36 x 36
3-Digit Shields	45 x 36	—	—	—	45 x 36
U.S. or State Route Signs					
Numerals	18	18	18	12	18
1- or 2-Digit Shields	36 x 36	36 x 36	36 x 36	24 x 24	36 x 36
3-Digit Shields	45 x 36	45 x 36	45 x 36	30 x 24	45 x 36
U.S. or State Route Text Identification (Example: US 56)					
Numerals & Letters	18	15	15	12	15
Cardinal Directions					
First Letters	18	15	12	10	15
Rest of Words	15	12	10	8	12
Auxiliary and Alternative Route Legends (Examples: JCT, TO, ALT, BUSINESS)					
Words	15	12	10	8	12
Names of Destinations					
Type of Sign	Type of Interchange (see Section 2E.32 of the MUTCD)				Overhead
	Major		Intermediate	Minor	
	Category a	Category b			
Upper-Case Letters	20	16	13.33	10.67	16
Lower-Case Letters	15	12	10	8	12
Distance Numbers	18	15	12	10	15
Distance Fraction Numerals	12	10	10	8	10
Distance Words	12	10	10	8	10
Action Message Words	10	10	10	8	10
<b>B. Gore Signs</b>					
Words	10	10	10	8	—
Numerals & Letters	12	12	12	10	—

Note: Sizes are shown in inches and where applicable are shown as width x height

**Table 2E-3. Minimum Letter and Numeral Sizes for Expressway Guide Signs According to Sign Type**

Type of Sign	Minimum Size
<b>A. Pull-Through Signs</b>	
Destinations — Upper-Case Letters	13.33
Destinations — Lower-Case Letters	10
Route Signs	
1- or 2-Digit Shields	36 x 36
3-Digit Shields	45 x 36
Cardinal Directions — First Letters	12
Cardinal Directions — Rest of Word	10
<b>B. Supplemental Guide Signs</b>	
Exit Number — Words	8
Exit Number — Numerals and Letters	12
Place Names — Upper-Case Letters	10.67
Place Names — Lower-Case Letters	8
Action Messages	8
Route Signs	
Numerals	12
1- or 2-Digit Shield	24 x 24
3-Digit Shield	30 x 24
<b>C. Interchange Sequence or Community Interchanges Identification Signs</b>	
Words — Upper-Case Letters	10.67
Words — Lower-Case Letters	8
Numerals	10.67
Fraction Numerals	8
Route Signs	
Numerals	12
1- or 2-Digit Shield	24 x 24
3-Digit Shield	30 x 24
<b>D. Next XX Exits Sign</b>	
Place Names — Upper-Case Letters	10.67
Place Names — Lower-Case Letters	8
NEXT XX EXITS — Words	8
NEXT XX EXITS — Number	12

Type of Sign	Minimum Size
<b>E. Distance Signs</b>	
Words — Upper-Case Letters	8
Words — Lower-Case Letters	6
Numerals	8
Route Signs	
Numerals	9
1- or 2-Digit Shield	18 x 18
3-Digit Shield	22.5 x 18
<b>F. General Services Signs (see Chapter 2I)</b>	
Exit Number — Words	8
Exit Number — Numerals and Letters	12
Services	8
<b>G. Rest Area, Scenic Area, and Roadside Area Signs (see Chapter 2I)</b>	
Words	10
Distance Numerals	12
Distance Fraction Numerals	8
Distance Words	8
Action Message Words	10
<b>H. Reference Location Signs (see Chapter 2H)</b>	
Words	4
Numerals	10
<b>I. Boundary and Orientation Signs (see Chapter 2H)</b>	
Words — Upper-Case Letters	8
Words — Lower-Case Letters	6
<b>J. Next Exit and Next Services Signs</b>	
Words and Numerals	8
<b>K. Exit Only Signs</b>	
Words	12
<b>L. Overhead Arrow-Per-Lane and Diagrammatic Signs</b>	
See Table 2E-5	

Note: Sizes are shown in inches and where applicable are shown as width x height



**Table 2E-4. Minimum Letter and Numeral Sizes for Freeway Guide Signs According to Interchange Classification**

Type of Sign	Type of Interchange (see Section 2E.32 of the MUTCD)				Overhead
	Major		Intermediate	Minor	
	Category a	Category b			
<b>A. Advance Guide, Exit Direction, and Overhead Guide Signs</b>					
Exit Number Plaques					
Words	10	10	10	10	10
Numerals & Letters	15	15	15	15	15
Interstate Route Signs					
Numerals	24/18	—	—	—	18
1- or 2-Digit Shields	48 x 48/ 36 x 36	—	—	—	36 x 36
3-Digit Shields	60 x 48/ 45 x 36	—	—	—	45 x 36
U.S. or State Route Signs					
Numerals	24/18	18	18	12	18
1- or 2-Digit Shields	48 x 48/ 36 x 36	36 x 36	36 x 36	24 x 24	36 x 36
3-Digit Shields	60 x 48/ 45 x 36	45 x 36	45 x 36	30 x 24	45 x 36
U.S. or State Route Text Identification (Example: US 56)					
Numerals & Letters	18	18/15	15	12	15
Cardinal Directions					
First Letters	18	15	15	10	15
Rest of Words	15	12	12	8	12
Auxiliary and Alternative Route Legends (Examples: JCT, TO, ALT, BUSINESS)					
Type of Sign	Type of Interchange (see Section 2E.32 of the MUTCD)				Overhead
	Major		Intermediate	Minor	
	Category a	Category b			
Words	15	12	12	8	12
Names of Destinations					
Upper-Case Letters	20	20	16	13.33	16
Lower-Case Letters	15	15	12	10	12
Distance Numbers	18	18/15	15	12	15
Distance Fraction Numerals	12	12/10	10	8	10
Distance Words	12	12/10	10	8	10
Action Message Words	12	12/10	10	8	10
<b>B. Gore Signs</b>					
Words	12	12	12	8	—
Numeral & Letters	18	18	18	12	—

Notes: 1. Sizes are shown in inches and where applicable are shown as width x height  
 2. Slanted line (/) signifies separation of desirable and minimum sizes

**Table 2E-5. Minimum Letter and Numeral Sizes for Freeway Guide Signs According to Sign Type**

Type of Sign	Minimum Size
<b>A. Pull-Through Signs</b>	
Destinations — Upper-Case Letters	16
Destinations — Lower-Case Letters	12
Route Signs	
1- or 2-Digit Shields	36 x 36
3-Digit Shields	45 x 36
Cardinal Directions — First Letter	15
Cardinal Directions — Rest of Word	12
<b>B. Supplemental Guide Signs</b>	
Exit Number Words	10
Exit Number Numerals and Letters	15
Place Names — Upper-Case Letters	13.33
Place Names — Lower-Case Letters	10
Action Messages	8
Route Signs	
Numerals	12
1- or 2-Digit Shield	24 x 24
3-Digit Shield	30 x 24
<b>C. Interchange Sequence or Community Interchanges Identification Signs</b>	
Words — Upper-Case Letters	13.33
Words — Lower-Case Letters	10
Numerals	13.33
Fraction Numerals	10
Route Signs	
Numerals	12
1- or 2-Digit Shield	24 x 24
3-Digit Shield	30 x 24
<b>D. Next X Exits Sign</b>	
Place Names — Upper-Case Letters	13.33
Place Names — Lower-Case Letters	10
NEXT X EXITS — Words	10
NEXT X EXITS — Number	15
<b>E. Distance Signs</b>	
Words — Upper-Case Letters	8
Words — Lower-Case Letters	6
Numerals	8
Route Signs	
Numerals	9
1- or 2-Digit Shield	18 x 18
3-Digit Shield	22.5 x 18
<b>F. General Services Signs (see Chapter 2I)</b>	
Exit Number Words	10
Exit Number Numerals and Letters	15
Services	10

Type of Sign	Minimum Size
<b>G. Rest Area, Scenic Area, and Roadside Area Signs (see Chapter 2I)</b>	
Words	12
Distance Numerals	15
Distance Fraction Numerals	10
Distance Words	10
Action Message Words	12
<b>H. Reference Location Signs (see Chapter 2H)</b>	
Words	4
Numerals	10
<b>I. Boundary and Orientation Signs (see Chapter 2H)</b>	
Words — Upper-Case Letters	8
Words — Lower-Case Letters	6
<b>J. Next Exit and Next Services Signs</b>	
Words and Numerals	8
<b>K. Exit Only Signs</b>	
Words	12
<b>L. Overhead Arrow-Per-Lane Signs</b>	
Arrowhead (Type D Directional Arrow)	21.625
Arrow Shaft Width	8
Arrow Height	
Through	72
Left Only	48
Right Only	48
Optional-Diverge (Through with Left or Right)	72
Optional-Split (Left and Right)	66
Vertical Separator Width	2
Vertical Space between Vertical Separator and Top of Nearest Arrow	8
Horizontal Space between Vertical Separator and Top of Nearest Through Arrow	15
Horizontal Space between Arrow Shaft and EXIT and ONLY plaques	10
EXIT and ONLY Panels	60 x 18
<b>M. Diagrammatic Signs</b>	
Arrowhead (Type D Directional Arrow)	13.5*
Lane Widths	5
Lane Line Segments	1 x 6
Spacing between Lane Line Segments	6
Stem Height to Upper Point of Departure	30
Horizontal Space between Arrowhead and Route Shield or Destination	12

\* The size shown is the arrowhead width per lane depicted on the corresponding arrow shaft

Note: Sizes are shown in inches and where applicable are shown as width x height

0714 Designs for upper-case and lower-case alphabets together with tables of recommended letter spacing, are shown in the "Standard Highway Signs and Markings" book (see [Section 1A.11 of this Supplement](#)) and the "Virginia Standard Highway Signs" book (see [Appendix A for link](#)).

*Guidance:*

0815 *Freeway lettering sizes (see Tables 2E-4 and 2E-5) should be used when expressway geometric design is comparable to freeway standards.*

0916 *Other sign letter size requirements not specifically identified elsewhere in this Manual should be guided by these specifications. Abbreviations (see [Section 2E.17 of the MUTCD](#)) should be kept to a minimum.*

*Support:*

1017 A sign mounted over a particular roadway lane to which it applies might have to be limited in horizontal dimension to the width of the lane, so that another sign can be placed over an adjacent lane. The necessity to maintain proper vertical clearance might also place a further limitation on the size of the overhead sign and the legend that can be accommodated.

## **Section 2E.27 Route Signs and Trailblazer Assemblies**

**Standard:**

01 **The official Route sign for the Interstate Highway System shall be the red, white, and blue retroreflective distinctive shield adopted by the American Association of State Highway and Transportation Officials (see [Section 2D.11 of this Supplement](#)).**

*Guidance:*

02 *Route signs (see [Figure 2E-17 in this Supplement](#)) should be incorporated as cut-out shields or other distinctive shapes on large directional guide signs. Where the Interstate shield is displayed in an assembly or on the face of a guide sign with U.S. or [Virginia Primary](#) Route signs, the Interstate numeral should be at least equal in size to the numerals on the other Route signs. The use of independent Route signs should be limited primarily to route confirmation assemblies.*

03 *Route signs and auxiliary signs showing junctions and turns should be used for guidance on approach roads, for route confirmation just beyond entrances and exits, and for reassurance along the freeway or expressway. When used along the freeway or expressway, the Route signs should be enlarged to a 36 x 36-inch minimum size for [US and Virginia Primary](#) routes with one or two digits, to a 45 x 36-inch minimum size for [US and Virginia Primary](#) routes with three digits, or to a 36 x 36-inch minimum size for [Virginia Secondary](#) routes, as shown in the "Standard Highway Signs and Markings" book and "[Virginia Standard Highway Signs](#)" book (see [Section 1A.11 of this Supplement](#)). When independently mounted Route signs are used in place of Pull-Through signs, they should be located just beyond the exit.*





## Figure 2E-17(VA) Interstate, Off-Interstate, U.S. Route, Virginia Primary Route, and Virginia Circular Secondary Route Signs

FOR GUIDE SIGN AND INDEPENDENT USE



M1-1

OR



M1-2



M1-3

FOR GUIDE SIGN USE



M1-4

OR



FOR INDEPENDENT USE



M1-4

OR



M1-V1b



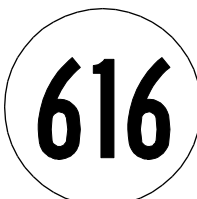
M1-V1d



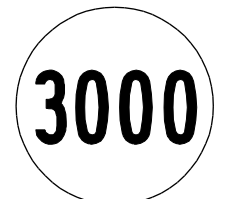
M1-V1a



M1-V1c



M1-V2b



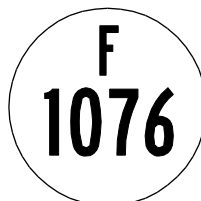
M1-V2d



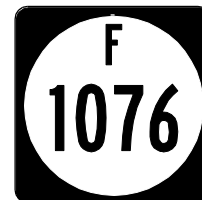
M1-V2a



M1-V2c



M1-V2f



M1-V2e

**Option:**

- 04 The standard Trailblazer Assembly (see [Section 2D.35 of the MUTCD](#)) may be used on roads leading to the freeway or expressway. Component messages of the Trailblazer Assembly may be included on a single sign in accordance with the provisions of [Section 2D.12 of this Supplement](#). Independently mounted Route signs may be used instead of Pull-Through signs (see [Section 2E.12 of the MUTCD](#)) as confirmation information.

**Support:**

- 05 [Section 2H.07 of the MUTCD](#) contains information regarding the design of signs for Auto Tour Routes.

**Option:**

- 06 The commonly used name or trailblazer route sign for a toll highway (see Chapter 2F) may be displayed on non-toll sections of the Interstate Highway System at:
- A. The last exit before entering a toll section of the Interstate Highway System;
  - B. The interchange or connection with a toll highway, whether or not the toll highway is a part of the Interstate Highway System; and
  - C. Other locations within a reasonable approach distance of toll highways when the name or trailblazer symbol for the toll highway would provide better guidance to road users unfamiliar with the area than would place names and route numbers.
- 07 The toll highway name or route sign may be included as a part of the guide sign installations on intersecting highways and approach roads to indicate the interchange with a toll section of an Interstate route. Where needed for the proper direction of traffic, a trailblazer for a toll highway that is part of the Interstate Highway System may be displayed with the Interstate Trailblazer Assembly.

**Support:**

- 08 Chapter 2F contains additional information regarding signing for toll highways.

## CHAPTER 2F: TOLL ROAD SIGNS

### Section 2F.12 Electronic Toll Collection (ETC) Account-Only Auxiliary Signs (M4-16 and M4-20)

**Standard:**

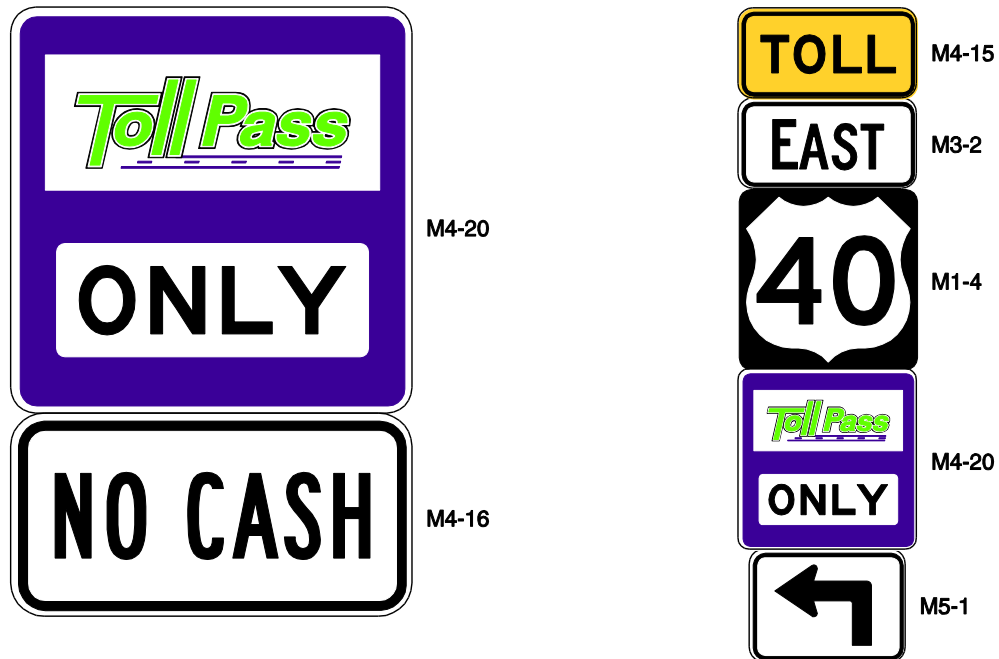
- 01 In any route sign assembly providing directions from a non-toll highway to a toll facility, or to a tolled segment of a highway, where electronic toll collection (ETC) is the only payment method accepted and all vehicles are required to have a registered ETC account, the ETC Account-Only (M4-20) auxiliary sign (see Figure 2F-4) shall be mounted directly below the route sign of the numbered or named toll facility. The M4-20 auxiliary sign shall have a white border and purple background and incorporate the pictograph adopted by the toll facility's ETC payment system and the word ONLY in black letters on a white panel set on the purple background of the sign.

*Guidance:*



- 02 If used, the NO CASH (M4-16) auxiliary sign and/or other auxiliary sign listing payment restrictions, or allowable payment methods, should be used in a route sign assembly directly below the M4-20 auxiliary sign.

**Figure 2F-4. ETC Account-Only Auxiliary Signs for Use in Route Sign Assemblies**



NOTE: The ETC pictograph shown is an example only. The pictograph for the toll facility's adopted ETC system shall be used.

Example Route Sign Assembly



## **Section 2F.V1 Toll Payment Regulatory Signs**

### *Guidance:*

- 01 *Payment restrictions, or allowable payment methods, should be listed prior to the entrance to the toll facility. An auxiliary sign with a black legend and border on a white background should be used to list payment restrictions or allowable payment methods.*

### *Support:*

- 02 Advance notice of being required to pay a toll and notification of being required to pay with exact change is necessary to allow enforcement of the Code of Virginia § 46.2-819.

### *Option:*

- 03 If engineering judgment determines that the payment restrictions cannot be listed on an auxiliary sign in the route sign assembly, a supplemental sign listing the payment restrictions may be used.

### *Support:*

- 04 Examples of payment restrictions that can be used on the auxiliary sign or supplemental sign include, but are not limited to, "Credit Cards Only", "Exact Change Only", or signs restricting payment type during certain times, e.g. "Exact Change Only 9:00 PM to 5:30 AM."

# CHAPTER 2H. GENERAL INFORMATION SIGNS

## Section 2H.02 General Information Signs (I Series)

Support:

- 01 Of interest to the traveler, though not directly necessary for guidance, are numerous kinds of information that can properly be conveyed by General Information signs (see [Figure 2H-1\(VA\) in this Supplement](#)) or miscellaneous information signs (see [Section 2H.04 of this Supplement](#)). They include such items as State lines, city limits, other political boundaries, time zones, stream names, elevations, landmarks, and similar items of geographical interest, and safety and transportation-related messages. Chapter 2M contains recreational and cultural interest area symbol signs that are sometimes used in combination with General Information signs.

Guidance:

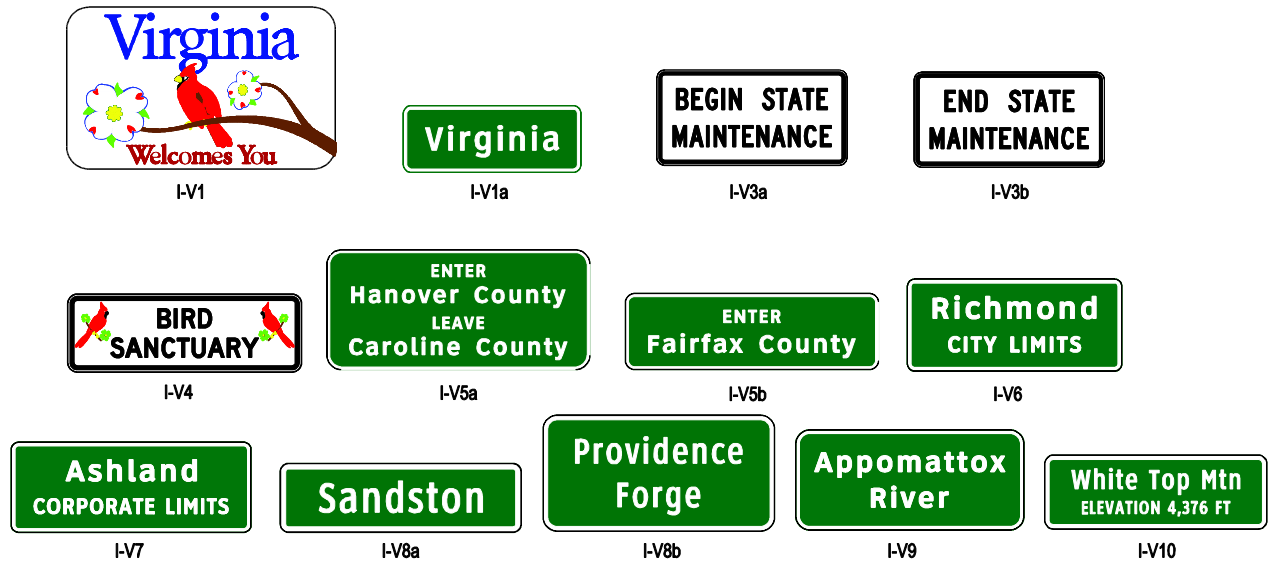
- 02 *General Information signs should not be installed within a series of guide signs or at other equally critical locations, unless there are specific reasons for orienting the road user or identifying control points for activities that are clearly in the public interest. On all such signs, the designs should be simple and dignified, devoid of any advertising, and in general compliance with other guide signing.*

**Figure 2H-1(VA). General Information and Miscellaneous Information Signs (sheet 1 of 2)**





## Figure 2H-1(VA). General Information and Miscellaneous Information Signs (sheet 2 of 2)



### Standard:

- 03 Except for political boundary signs, General Information signs shall have white legends and borders on green rectangular-shaped backgrounds.

### Option:

- 04 An information symbol sign (I-5 through I-9) may be used to identify a route leading to a transportation or general information facility, or to provide additional guidance to the facility. The symbol sign may be supplemented by an educational plaque where necessary; also, the name of the facility may be used if needed to distinguish between similar facilities.
- 05 The Advance Turn (M5 series) or Directional Arrow (M6 series) auxiliary signs shown in [Figure 2H-1\(VA\) in this Supplement](#) with white arrows on green backgrounds may be used with General Information symbol signs to create a General Information Directional Assembly.
- 06 Guide signs for commercial service airports and non-carrier airports may be provided from the nearest Interstate, other freeway, or conventional highway intersection directly to the airport, normally not to exceed 15 miles. The Airport (I-5) symbol sign along with a supplemental plaque may be used to indicate the specific name of the airport. An Airport symbol sign, with or without a supplemental name plaque or the word AIRPORT, and an arrow may be used as a trailblazer.

### Standard:

- 07 Adequate trailblazer signs shall be in place prior to installing the airport guide signs.

**Support:**

- 08 Location and placement of all airport guide signs depends upon the availability of longitudinal spacing on highways.

**Option:**

- 09 The Recycling Collection Center (I-11) symbol sign may be used to direct road users to recycling collection centers.

**Guidance:**

- 10 *The Recycling Collection Center symbol sign should not be used on freeways and expressways.*

**Standard:**

- 11 **If used on freeways or expressways, the Recycling Collection Center symbol sign shall be considered one of the supplemental sign destinations.**
- 12 **When a sign is used to display a safety or transportation-related message, the display format shall not be of a type that would be considered similar to advertising displays. Messages and symbols that resemble any official traffic control device shall not be used on safety or transportation-related message signs.**

**Option:**

- 13 The pictograph of a political jurisdiction (such as a State, county, or municipal corporation) may be displayed on a political boundary General Information sign.

**Standard:**

- 14 **If used, the height of a pictograph on a political boundary General Information sign shall not exceed two times the height of the upper-case letters of the principal legend on the sign. The pictograph shall comply with the provisions of [Section 2A.06 of this Supplement](#).**



- 15 **[The Virginia Welcomes You \(I-V1\) sign shall be installed on Interstates, U.S., and Primary routes at the State line in the direction entering the State.](#)**

**Option:**

- 16 [The Virginia Welcomes You \(I-V1\) sign may also be installed at Rest Areas and Welcome Centers, and on roadways near major airports and seaports.](#)

**Guidance:**


- 17 *[The smaller version of the I-V1 sign \(I-V1a\), bearing only the text “Virginia,” should be installed on Secondary routes at the State line in the direction entering the State.](#)*

## **Section 2H.04 Miscellaneous Information Signs**

**Support:**

- 01 Miscellaneous information are used to point out geographical features, such as rivers and summits, and other jurisdictional boundaries (see [Section 2H.02 of this Supplement](#)). [Figure 2H-1\(VA\) in this Supplement](#) shows examples of miscellaneous information signs.

**Table 2H-1(VA). General Information Sign Sizes**

Sign	Sign Designation	Section	Conventional Road	Freeway or Expressway
Reference Location (1 digit)	D10-1	2H.05	10 x 18	12 x 24
Intermediate Reference Location (2 digits)	D10-1a	2H.05	10 x 27	12 x 36
Reference Location (2 digits)	D10-2	2H.05	10 x 27	12 x 36
Intermediate Reference Location (3 digits)	D10-2a	2H.05	10 x 36	12 x 48
Reference Location (3 digits)	D10-3	2H.05	10 x 36	12 x 48
Intermediate Reference Location (4 digits)	D10-3a	2H.05	10 x 48	12 x 60
Enhanced Reference Location	D10-4	2H.06	18 x 54	18 x 54
Intermediate Enhanced Reference Location	D10-5	2H.06	18 x 60	18 x 60
Acknowledgement	D14-1	2H.08	36 x 30*	72 x 48*
<b>ADOPT A HIGHWAY</b>	<b>D14-V1</b>	<b>2H.08</b>	<b>36 x 24</b>	—
Acknowledgement	D14-2	2H.08	36 x 30*	72 x 48*
<b>Acknowledgement</b>	<b>D14-3</b>	<b>2H.08</b>	<b>42 x 24*</b>	<b>96 x 36*</b>
Signals Set for XX MPH	I1-1	2H.03	24 x 36	—
Jurisdictional Boundary	I-2	2H.04	Varies x 18**	Varies x 36**
<b>Geographical Features</b>	<b>I-3</b>	<b>2H.04</b>	<b>Varies x 18**</b>	<b>Varies x 36**</b>
Airport	I-5	2H.02	24 x 24	30 x 30
Bus Station	I-6	2H.02	24 x 24	30 x 30
Train Station	I-7	2H.02	24 x 24	30 x 30
Library	I-8	2H.02	24 x 24	30 x 30
Vehicle Ferry Terminal	I-9	2H.02	24 x 24	30 x 30
Recycling Collection Center	I-11	2H.02	30 x 48	—
Light Rail Transit Station	I-12	2H.02	24 x 24	—
 <b>Virginia Specific Signs</b>				
Sign or Plaque	Sign Designation	Section	Conventional Road	Freeway or Expressway
Grade Separated Cross Road ID	D10-V1	2H.V1	Var. x 24	Var. x 24
Virginia Welcomes You	I-V1	2H.02	120 x 72***	156 x 96
Virginia	I-V1a	2H.02	48 x 18	—
BEGIN STATE MAINTENANCE	I-V3a	2H.04	36 x 18	36 x 18
END STATE MAINTENANCE	I-V3b	2H.04	36 x 18	36 x 18
BIRD SANCTUARY	I-V4	2H.04	36 x 12	—
ENTER (Jurisdiction) - LEAVE (Jurisdiction)	I-V5a	2H.04	Var. x 36****	Var. x 60
ENTER (Jurisdiction)	I-V5b	2H.04	Var. x 18*****	Var. x 36
CITY LIMITS	I-V6	2H.04	Var. x 18	Var. x 36
CORPORATE LIMITS	I-V7	2H.04	Var. x 18	Var. x 36
UNINCORPORATED PLAGE (One Line)	I-V8a	2H.04	Var. x 12	—
UNINCORPORATED PLAGE (Two Lines)	I-V8b	2H.04	Var. x 24	—
Named Waterway	I-V9	2H.04	Var. x 18	Var. x 42
MOUNTAIN CROSSING	I-V10	2H.04	Var. x 12	—

\*— The size shown is the maximum size for the corresponding roadway classification. The size of the sign and acknowledgement logo should be appropriately reduced where shorter legends are used.

\*\* The size shown is for the typical sign illustrated in the figure. The size should be determined based on the amount of legend required for the sign.

\*\*\* 78 x 48 sign size may be used on two-lane, two-way conventional primary roadways.

\*\*\*\* Var. x 24 sign size may be used on two-lane, two-way conventional primary roadways.

\*\*\*\*\* Var. x 12 sign size may be used on two-lane, two-way conventional primary roadways.

Notes: 1. Larger signs may be used when appropriate, except for the D14 series signs

2. Dimensions in inches are shown as width x height

**Option:**

- 02 Miscellaneous information signs may be used if they do not interfere with signing for interchanges or other critical points.

**Guidance:**

- 03 *Miscellaneous information signs should not be installed unless there are specific reasons for orienting the road users or identifying control points for activities that are clearly in the public interest. If miscellaneous information signs are to be of value to the road user, they should be consistent with other guide signs in design and legibility. On all such signs, the design should be simple and dignified, devoid of any tendency toward flamboyant advertising, and in general compliance with other signing.*

**Guidance:**

- 04 *When a roadway changes between VDOT maintained and non-VDOT maintained sections, END STATE MAINTENANCE (I-V3b) signs (see Figure 2H-1(VA) in this Supplement) should be installed at the end of those sections of routes maintained by VDOT.*

**Option:**

- 05 When a roadway changes between VDOT maintained and non-VDOT maintained sections, BEGIN STATE MAINTENANCE (I-V3a) signs (see Figure 2H-1(VA) in this Supplement) may be installed at the beginning of those sections of routes maintained by VDOT.
- 06 BIRD SANCTUARY (I-V4) signs (see Figure 2H-1(VA) in this Supplement) may be installed at locations that have been officially designated as Bird Sanctuaries.

**Support:**

- 07 Bird Sanctuaries are designated by resolution of local governing bodies.

**Standard:**

- 08 **Except as provided in Paragraphs 10 and 11, ENTER/LEAVE boundary (I-V5a) signs (see Figure 2H-1(VA) in this Supplement) shall be installed as near as possible to the jurisdictional line between two counties, between a county and a city, or between two cities.**

**Guidance:**

- 09 *ENTER boundary (I-V5b) signs (see Figure 2H-1(VA) in this Supplement) should be installed at the State line to inform traffic entering Virginia of the name of the local jurisdiction. Signs should be placed 350 to 500 feet downstream from the I-V1 or I-V1a signs.*

**Option:**

- 10 CITY LIMITS (I-V6) signs (see Figure 2H-1(VA) in this Supplement) may be installed on Interstates, U.S., and Primary routes entering a city, as near as possible to the city limits, instead of the ENTER/LEAVE boundary signs (I-V5a).
- 11 CORPORATE LIMITS (I-V7) signs (see Figure 2H-1(VA) in this Supplement) may be installed on Interstates, U.S., and Primary routes entering an incorporated town, as near as possible to the limits of incorporated towns.



- 12 Signs indicating the name of unincorporated places (I-V8) may be installed based on engineering judgment (see Figure 2H-1(VA) in this Supplement).
- 13 Mountaintop Location (I-V10) signs (see Figure 2H-1(VA) in this Supplement) may be installed at the crest of a mountain crossing to identify the mountain and its elevation.

**Standard:**

- 14 **Named Waterway (I-V9) signs (see Figure 2H-1(VA) in this Supplement) shall be installed at the approach end of all bridges over waterways.**

**Option:**

- 15 “A Scenic River” legend may be added to signs indicating that the waterway is a Virginia Scenic River. Legend may also be added to signs indicating that the waterway is part of a particular Watershed.

**Support:**

- 16 For further information regarding Scenic River and Watershed signing, refer to the VDOT Integrated Directional Signing Program on the VDOT website (address provided in Appendix A of this Supplement).



**Section 2H.05 Reference Location Signs (D10-1 through D10-3), Intermediate Reference Location Signs (D10-1a through D10-3a), and Virginia Interstate Intermediate Reference Location Signs (D10-V1a through D10-V3a)** (This Section has been added to the Virginia Supplement to the MUTCD - Revision 1).\*

**Support:**



- 01 There are ~~two~~ three types of reference location signs: \*
  - A. Reference Location (D10-1, 2, and 3) signs show an integer distance point along a highway, ~~and~~\*
  - B. Intermediate Reference Location (D10-1a, 2a, and 3a) signs, *which* also show a decimal between integer distance points along a highway, ~~and~~\*
  - C. Virginia Interstate Intermediate Reference Location (D10-V1a, D10-V2a, and D10-V3a) signs, *which* are modified sign panel layouts for the D10-1a, D10-2a, and D10-3a signs (see Figure 2H-3(VA) in this Supplement). \*

**Standard:**

- 02 **Except when Enhanced Reference Location signs (see Section 2H.06 of the MUTCD) are used instead, Reference Location (D10-1 through D10-3) signs shall be placed on all expressway facilities that are located on a route where there is reference location sign continuity and on all freeway facilities to assist road users in estimating their progress, to provide a means for identifying the location of emergency incidents and traffic crashes, and to aid in highway maintenance and servicing. \***

**Option:**

03 Reference Location (D10-1 to D10-3) signs (see Figure 2H-2) may be installed along any section of a highway route or ramp to assist road users in estimating their progress, to provide a means for identifying the location of emergency incidents and traffic crashes, and to aid in highway maintenance and servicing.\*

04 To augment the reference location sign system, Intermediate Reference Location (D10-1a to D10-3a) signs (see Figure 2H-3), which show the tenth of a mile with a decimal point, may be installed at one tenth of a mile intervals, or at some other regular spacing.\*

**Standard:**

05 When used on an Expressway or Freeway, the Virginia Interstate Intermediate Reference Location (D10-V1a, D10-V2a, and D10-V3a) signs shall be installed in lieu of Intermediate Reference Location (D10-1a to D10-3a) signs.\*

0506 When Intermediate Reference Location (D10-1a to D10-3a) or Virginia Interstate Intermediate (D10-V1a to D10-V3a) signs are used to augment the reference location sign system, the reference Reference Location (D10-1 to D10-3) signs at the integer mile point shall display a decimal point and a zero numeral.\*

**Guidance:**

07 When the Enhanced Reference Location signs are used with the Intermediate Reference Location (D10-1a to D10-3a) signs or Virginia Interstate Intermediate Reference Location (D10-V1a to D10-V3a) sign, the Enhanced Reference Location signs without the decimal point and a zero numeral (D10-4) should be used.\*

**Standard:**

0608 When placed on freeways or expressways Except when the Enhanced Reference Location signs are used, the reference location signs on freeways or expressways shall contain 10-inch white numerals on a 12-inch wide green background with a white border. The signs shall be 24, 36, or 48 inches in height for one, two, or three digits, respectively, and shall contain the word MILE in 4-inch white letters.\*

09 When Virginia Interstate Intermediate (D10-V1a to D10-V3a) signs are used, signs shall contain 8 inch white numerals on a 10 inch wide green background with a white border. The signs shall be 27, 36, or 48 inches in height for two, three or four digits, respectively, and shall contain the word MILE in 4-inch white letters.\*

0710 When placed on conventional roads, reference location signs shall contain 6-inch white numerals on a green background that is at least 10 inches wide with a white border. The signs shall contain the word MILE in 4-inch white letters.\*

0811 Reference location signs shall have a minimum mounting height of 4 feet, measured vertically from the bottom of the sign to the elevation of the near edge of the roadway, and shall not be governed by the mounting height requirements prescribed in Section 2A.18 in this Supplement.\*

0912 The distance numbering shall be continuous for each route within a State, except where overlaps occur (see Section 2E.31 of the MUTCD\*). Where routes overlap, reference location sign continuity shall be established for only one of the routes. If



**one of the overlapping routes is an Interstate route, that route shall be selected for continuity of distance numbering. \***

**Guidance:**

**1013** *The route selected for continuity of distance numbering should also have continuity in interchange exit numbering (see [Section 2E.31 of the MUTCD](#)).\**

**1114** *On a route without reference location sign continuity, the first reference location sign beyond the overlap should indicate the total distance traveled on the route so that road users will have a means of correlating their travel distance between reference location signs with that shown on their odometer.\**

**Standard:**

**1215** **For divided highways, the distance measurement shall be made on the northbound and eastbound roadways. The reference location signs for southbound or westbound roadways shall be set at locations directly opposite the reference location signs for the northbound or eastbound roadways.\***

**Figure 2H-2. Reference Location Signs\***



**Figure 2H-3(VA). Intermediate Reference Location Signs***(This Figure has been updated for the Virginia Supplement to the MUTCD – Revision 1.)\****Guidance:**

1316 Zero distance should begin at the south and west State lines, or at the south and west terminus points where routes begin within a State.\*

**Standard:**

1417 Except as provided in Paragraph 15 18 (updated reference), reference location signs shall be installed on the right-hand side of the roadway.\*

**Option:**

1518 Where conditions limit or restrict the use of reference location signs on the right-hand side of the roadway, they may be installed in the median. On two-lane conventional roadways, reference location signs may be installed on one side of the roadway only and may be installed back-to-back. Reference location signs may be placed up to 30 feet from the edge of the pavement.\*


1619 If a reference location sign cannot be installed in the correct location, it may be moved in either direction as much as 50 feet.\*

**Guidance:**

1720 If a reference location sign cannot be placed within 50 feet of the correct location, it should be omitted.\*



**Table 2H-1(VA). General Information Sign Sizes**

Sign	Sign Designation	Section	Conventional Road	Freeway or Expressway
Reference Location (1 digit)	D10-1	2H.05	10 x 18	12 x 24
Intermediate Reference Location (2 digits)	D10-1a	2H.05	10 x 27	12 x 36
Virginia Interstate Intermediate Reference Location (2 digits)	D10-V1a	2H.05		10 x 27
Reference Location (2 digits)	D10-2	2H.05	10 x 27	12 x 36
Intermediate Reference Location (3 digits)	D10-2a	2H.05	10 x 36	12 x 48
Virginia Interstate Intermediate Reference Location (3 digits)	D10-V2a	2H.05		10 x 36
Reference Location (3 digits)	D10-3	2H.05	10 x 36	12 x 48
Intermediate Reference Location (4 digits)	D10-3a	2H.05	10 x 48	12 x 60
Virginia Interstate Intermediate Reference Location (4 digits)	D10-V3a	2H.05		10 x 48
Enhanced Reference Location	D10-4	2H.06	18 x 54	18 x 54
Intermediate Enhanced Reference Location	D10-5	2H.06	18 x 60	18 x 60
Acknowledgement	D14-1	2H.08	36 x 30*	72 x 48*
ADOPT A HIGHWAY	D14-V1	2H.08	36 x 24	—
Acknowledgement	D14-2	2H.08	36 x 30*	72 x 48*
Acknowledgement	D14-3	2H.08	42 x 24*	96 x 36*
Signals Set for XX MPH	I1-1	2H.03	24 x 36	—
Jurisdictional Boundary	I-2	2H.04	Varies x 18**	Varies x 36**
Geographical Features	I-3	2H.04	Varies x 18**	Varies x 36**
Airport	I-5	2H.02	24 x 24	30 x 30
Bus Station	I-6	2H.02	24 x 24	30 x 30
Train Station	I-7	2H.02	24 x 24	30 x 30
Library	I-8	2H.02	24 x 24	30 x 30
Vehicle Ferry Terminal	I-9	2H.02	24 x 24	30 x 30
Recycling Collection Center	I-11	2H.02	30 x 48	—
Light Rail Transit Station	I-12	2H.02	24 x 24	—
 <b>Virginia Specific Signs</b>				
Sign or Plaque	Sign Designation	Section	Conventional Road	Freeway or Expressway
Grade Separated Cross Road ID	D10-V1	2H.V1	Var. x 24	Var. x 24
Virginia Welcomes You	I-V1	2H.02	120 x 72***	156 x 96
Virginia	I-V1a	2H.02	48 x 18	—
BEGIN STATE MAINTENANCE	I-V3a	2H.04	36 x 18	36 x 18
END STATE MAINTENANCE	I-V3b	2H.04	36 x 18	36 x 18
BIRD SANCTUARY	I-V4	2H.04	36 x 12	—
ENTER (Jurisdiction) - LEAVE (Jurisdiction)	I-V5a	2H.04	Var. x 36****	Var. x 60
ENTER (Jurisdiction)	I-V5b	2H.04	Var. x 18****	Var. x 36
CITY LIMITS	I-V6	2H.04	Var. x 18	Var. x 36
CORPORATE LIMITS	I-V7	2H.04	Var. x 18	Var. x 36
UNINCORPORATED PLACE (One Line)	I-V8a	2H.04	Var. x 12	—
UNINCORPORATED PLACE (Two Lines)	I-V8b	2H.04	Var. x 24	—
Named Waterway	I-V9	2H.04	Var. x 18	Var. x 42
MOUNTAIN CROSSING	I-V10	2H.04	Var. x 12	—

\*— The size shown is the maximum size for the corresponding roadway classification. The size of the sign and acknowledgement logo should be appropriately reduced where shorter legends are used.

- \*\* The size shown is for the typical sign illustrated in the figure. The size should be determined based on the amount of legend required for the sign.
- \*\*\* 78 x 48 sign size may be used on two-lane, two-way conventional primary roadways.
- \*\*\*\* Var. x 24 sign size may be used on two-lane, two-way conventional primary roadways.
- \*\*\*\*\* Var. x 12 sign size may be used on two-lane, two-way conventional primary roadways.
- Notes: 1. Larger signs may be used when appropriate, except for the D14 series signs  
2. Dimensions in inches are shown as width x height

## Section 2H.08 Acknowledgment Signs

### Support:

- 01 Acknowledgment signs are a way of recognizing a company, business, or volunteer group that provides a highway-related service. Acknowledgment signs include sponsorship signs for adopt-a-highway litter removal programs, maintenance of a parkway or interchange, and other highway maintenance or beautification sponsorship programs.

### Guidance:

- 02 *A State or local highway agency that elects to have an acknowledgment sign program should develop an acknowledgment sign policy. The policy should require that eligible sponsoring organizations comply with State laws prohibiting discrimination based on race, religion, color, age, sex, national origin, and other applicable laws. The acknowledgment sign policy should include all of the provisions regarding sign placement and sign design that are described in this Section.*

### Standard:

- 03 **Because regulatory, warning, and guide signs have a higher priority, acknowledgment signs shall only be installed where adequate spacing is available between the acknowledgment sign and other higher priority signs. Acknowledgment signs shall not be installed in a position where they would obscure the road users' view of other traffic control devices.**
- 04 **Acknowledgment signs shall not be installed at any of the following locations:**
- A. **On the front or back of, adjacent to, or around any other traffic control device, including traffic signs, highway traffic signals, and changeable message signs;**
  - B. **On the front or back of, adjacent to, or around the supports or structures of other traffic control devices, or bridge piers; or**
  - C. **At key decision points where a road user's attention is more appropriately focused on other traffic control devices, roadway geometry, or traffic conditions, including exit and entrance ramps, intersections, grade crossings, toll plazas, temporary traffic control zones, and areas of limited sight distance.**

### Guidance:

- 05 *The minimum spacing between acknowledgment signs and any other traffic control signs, except parking regulation signs, should be:*
- A. *150 feet on roadways with speed limits of less than 30 mph,*
  - B. *200 feet on roadways with speed limits of 30 to 45 mph, and*

*C. 500 feet on roadways with speed limits greater than 45 mph.*

- 06 *If the placement of a newly-installed higher-priority traffic control device, such as a higher-priority sign, a highway traffic signal, or a temporary traffic control device, conflicts with an existing acknowledgment sign, the acknowledgment sign should be relocated, covered, or removed.*

**Option:**

- 07 State or local highway agencies may develop their own acknowledgment sign designs and may also use their own pictograph (see definition in [Section 1A.13 of this Supplement](#)) and/or a brief jurisdiction-wide program slogan as part of any portion of the acknowledgment sign, provided that the signs comply with the provisions for shape, color, and lettering style in this Chapter and in Chapter 2A.

**Support:**

- 08 VDOT's Adopt-A-Highway program provides an opportunity for citizens, businesses, or civic groups to clean up litter from the sides of VDOT-maintained roadways. Additional program and contact information can be found at VDOT's website (see link in Appendix A of this Supplement) or by calling 1-800-PRIDE-VA.

**Standard:**

- 09 **ADOPT A HIGHWAY (D14-V1) signs and CLEANUP CREW WORKING (W21-V6) signs (see Figure 2H-5(VA) in this Supplement) shall be installed in accordance with program guidelines.**

**Option:**

- 10 The CLEANUP CREW WORKING (W21-V6) sign may be cut into two pieces (along the horizontal centerline axis) and hinged such that it can be folded when cleanup crews are not working.

**Guidance:**

- 11 *Acknowledgment signs should clearly indicate the type of highway services provided by the sponsor.*



## Figure 2H-5(VA). Examples of Acknowledgement Sign Designs



\* Sign specifically for use with Adopt-A-Highway Program

### Standard:

- 12 In addition to the general provisions for signs described in Chapter 2A and the sign design principles covered in the "Standard Highway Signs and Markings" book (see [Section 1A.11 of this Supplement](#)), acknowledgment sign designs developed by State or local highway agencies shall comply with the following provisions:
- Neither the sign design nor the sponsor acknowledgment logo shall contain any contact information, directions, slogans (other than a brief jurisdiction-wide program slogan, if used), telephone numbers, or Internet addresses, including domain names and uniform resource locators (URL);
  - Except for the lettering, if any, on the sponsor acknowledgment logo, all of the lettering shall be in upper-case letters as provided in the "Standard Highway Signs and Markings" book (see [Section 1A.11 of this Supplement](#));
  - In order to keep the main focus on the highway-related service and not on the sponsor acknowledgment logo, the area reserved for the sponsor

**acknowledgment logo shall not exceed 1/3 of the total area of the sign and shall be a maximum of 8 square feet, and shall not be located at the top of the sign;**

- D. The entire sign display area shall not exceed 24 square feet;**
- E. The sign shall not contain any messages, lights, symbols, or trademarks that resemble any official traffic control devices;**
- F. The sign shall not contain any external or internal illumination, light-emitting diodes, luminous tubing, fiber optics, luminescent panels, or other flashing, moving, or animated features; and**
- G. The sign shall not distract from official traffic control messages such as regulatory, warning, or guidance messages.**

Support:

- 13 Examples of acknowledgment sign designs are shown in [Figure 2H-5\(VA\)](#) in this Supplement.



## **Section 2H.V1 Crossroad Identification (D10-V1) Signs**

**Standard:**

- 01 **Crossroad Identification (D10-V1) signs (see Figure 2H-V1 in this Supplement) shall be installed in both directions of travel on limited access roadways identifying the route number and the street name of grade-separated roadways.**
- 02 **Where roadways cross over or under a limited access roadway without direct access to the limited access roadway, one set of crossroad identification signs shall be installed on the limited access roadway.**
- 03 **Except as provided in Paragraphs 4 and 5 below, crossroad identification signs shall be installed at underpasses, attached to the bridge that crosses the roadway. Signs shall be centered over the travel lanes.**
- 04 **Where there are existing bridge mounted signs over the roadway, crossroad identification signs shall be installed on the bridge over the right shoulder.**
- 05 **If it is not possible to install the sign on the bridge because of bridge design characteristics, a ground mounted sign shall be installed on the right side of the roadway as close as practical to the approach side of the structure.**
- 06 **At limited access roadway overpasses, ground mounted signs shall be installed on the right side of the roadway near the approach end of the bridge.**



## Figure 2H-V1. Crossroad Identification Sign



D10-V1

## CHAPTER 2I. GENERAL SERVICE SIGNS

### Section 2I.05 Rest Area and Other Roadside Area Signs

**Standard:**

- 01 Rest Area signs (see [Figure 2I-5\(VA\) in this Supplement](#)) shall have a retroreflective white legend and border on a blue background.
- 02 Signs that include the legend REST AREA shall be used only where parking and restroom facilities are available.

*Guidance:*

- 03 A roadside area that does not contain restroom facilities should be signed to indicate the major road user service that is provided. For example, the sign legends for an area with only parking should use the words PARKING AREA instead of REST AREA. The sign legends for an area with only picnic tables and parking should use words such as PICNIC AREA, ROADSIDE TABLE, or ROADSIDE PARK instead of REST AREA.
- 04 Rest areas that have tourist information and welcome centers should be signed as discussed in [Section 2I.08 of the MUTCD](#).
- 05 Scenic area signing should be consistent with that provided for rest areas, except that the legends should use words such as SCENIC AREA, SCENIC VIEW, or SCENIC OVERLOOK instead of REST AREA.
- 06 If a rest area or other roadside area is provided on a conventional road, a D5-1 and/or D5-1b sign should be installed in advance of the rest area or other roadside area to permit the driver to reduce speed in preparation for leaving the highway. A D5-5 sign (or a D5-2 sign if an exit ramp is provided) should be installed at the turnoff point where the driver needs to leave the highway to access the rest area or other roadside area.

**Figure 2I-5(VA). Rest Area and Other Road Side Area Signs**



- 07 *If a rest area or other roadside area is provided on a freeway or expressway, a D5-1 sign should be placed 1 mile and/or 2 miles in advance of the rest area.*

**Standard:**

- 08 **A D5-2 sign shall be placed at the rest area or other roadside area exit gore.**

**Option:**

- 09 A D5-1a sign may be placed between the D5-1 sign and the exit gore on a freeway or expressway. A second D5-1 sign may be used in place of the D5-1a sign with a distance to the nearest 1/2 or 1/4 mile displayed as a fraction rather than a decimal for distances of less than 1 mile.

**Standard:**

- 10 **To provide the road user with information on the location of succeeding rest areas, a NEXT REST AREA XX MILES (D5-6) sign (see Figure 2I-5(VA) in this Supplement) shall be installed if there is a succeeding rest area on that roadway that is open to passenger vehicles, whether the succeeding rest area is in Virginia or another state. If the roadway ends and no additional rest areas are present, the NEXT REST AREA XX MILES (D5-6) shall not be required.**

- 11 **NEXT REST AREA XX MILES (D5-6) signs shall be installed on the approaches to all rest areas on the Interstate system between the Rest Area advance sign and the ramp to the rest area.**

**Guidance:**

- 12 *D5-6 signs should be located following the Rest Area advance sign.*

**Standard:**

- 13 **All signs on freeways and expressways for rest and other roadside areas shall have letter and numeral sizes that comply with the minimum requirements of Tables 2E-2 through 2E-5. The sizes for General Service signs that have standardized designs shall be as shown in Table 2I-1(VA) in this Supplement.**

**Option:**

- 14 If the rest area has facilities for the physically impaired (see Section 2I.02 of the MUTCD), the International Symbol of Accessibility for the Handicapped (D9-6) sign (see Figure 2I-1) may be placed with or beneath the REST AREA advance guide sign.
- 15 If telecommunication devices for the deaf (TDD) are available at the rest area, the TDD (D9-21) symbol sign (see Figure 2I-1) may be used to supplement the advance guide signs for the rest area.
- 16 If wireless Internet services are available at the rest area, the Wi-Fi (D9-22) symbol sign (see Figure 2I-1) may be used to supplement the advance guide signs for the rest area.


**Standard:**

- 17 **"REST AREA PATROLLED BY STATE POLICE" (D0-V1) signs (see Figure 2I-5(VA) in this Supplement) shall be installed at each rest area and welcome center to promote security at each location. Signs shall be installed within the rest area and not on the ramps or freeway mainline.**



**Table 2I-1(VA). General Service Sign and Plaque Sizes**

Sign or Plaque	Sign Designation	Section	Conventional Road	Freeway or Expressway
Rest Area XX Miles	D5-1	2I.05	66 x 36*	96 x 54*
Rest Area Next Right	D5-1a	2I.05	78 x 36*	120 x 60* (F) 114 x 48* (E)
Rest Area (with arrow)	D5-2	2I.05	66 x 36*	96 x 54*
Rest Area Gore	D5-2a	2I.05	42 x 48*	78 x 78* (F) 66 x 72* (E)
Rest Area (with horizontal arrow)	D5-5	2I.05	42 x 48*	—
Next Rest Area XX Miles	D5-6	2I.05	60 x 48*	90 x 72*
Rest Area Tourist Info Center XX Miles	D5-7	2I.08	90 x 72*	144 x 102* (F) 132 x 96* (E)
Rest Area Tourist Info Center (with arrow)	D5-8	2I.08	84 x 72*	120 x 102* (F) 120 x 96* (E)
Rest Area Tourist Info Center Next Right	D5-11	2I.08	90 x 72*	144 x 102* (F) 132 x 96* (E)
Interstate Oasis	D5-12	2I.04	—	156 x 78
Interstate Oasis (plaque)	D5-12P	2I.04	—	114 x 48
Brake Check Area XX Miles	D5-13	2I.06	84 x 48	126 x 72
Brake Check Area (with arrow)	D5-14	2I.06	78 x 60	96 x 72
Chain-Up Area XX Miles	D5-15	2I.07	66 x 48	96 x 72
Chain-Up Area (with arrow)	D5-16	2I.07	72 x 54	96 x 66
Telephone	D9-1	2I.02	24 x 24	30 x 30
Hospital	D9-2	2I.02	24 x 24	30 x 30
Camping	D9-3	2I.02	24 x 24	30 x 30
Trailer Camping	D9-3a	2I.02	24 x 24	30 x 30
Litter Container	D9-4	2I.02	24 x 30	36 x 48
Handicapped	D9-6	2I.02	24 x 24	30 x 30
Van Accessible (plaque)	D9-6P	2I.02	18 x 9	—
Gas	D9-7	2I.02	24 x 24	30 x 30
Food	D9-8	2I.02	24 x 24	30 x 30
Lodging	D9-9	2I.02	24 x 24	30 x 30
Tourist Information	D9-10	2I.02	24 x 24	30 x 30
Diesel Fuel	D9-11	2I.02	24 x 24	30 x 30
Alternative Fuel - Compressed Natural Gas	D9-11a	2I.02	24 x 24	30 x 30
Electric Vehicle Charging	D9-11b	2I.02	24 x 24	30 x 30
Electric Vehicle Charging (plaque)	D9-11bP	2I.02	24 x 18	30 x 24
Alternative Fuel - Ethanol	D9-11c	2I.02	24 x 24	30 x 30
RV Sanitary Station	D9-12	2I.02	24 x 24	30 x 30
Emergency Medical Services	D9-13	2I.02	24 x 24	30 x 30
Hospital (plaque)	D9-13aP	2I.02	24 x 12	30 x 12
Ambulance Station (plaque)	D9-13bP	2I.02	24 x 12	30 x 15
Emergency Medical Care (plaque)	D9-13cP	2I.02	24 x 18	30 x 24

Sign or Plaque	Sign Designation	Section	Conventional Road	Freeway or Expressway
Trauma Center (plaque)	D9-13dP	2I.02	24 x 12	30 x 15
Police	D9-14	2I.02	24 x 24	30 x 30
Propane Gas	D9-15	2I.02	24 x 24	30 x 30
Truck Parking	D9-16	2I.02	24 x 24	30 x 30
Next Services XX Miles (plaque)	D9-17P	2I.02	102 x 24	156 x 30
General Services (up to 6 symbols)	D9-18	2I.03	—	96 x 60
General Services	D9-18a	2I.03	—	96 x 60
General Services (up to 6 symbols) with Action or Exit Information	D9-18b	2I.03	108 x 84	132 x 114 (F) 132 x 108 (E)
General Services with Action or Exit Information	D9-18c	2I.03	72 x 60**	132 x 108** (F) 108 x 84** (E)
Pharmacy	D9-20	2I.02	24 x 24	30 x 30
24-Hour (plaque)	D9-20aP	2I.02	24 x 12	30 x 12
Telecommunication Device for the Deaf	D9-21	2I.05	24 x 24	30 x 30
Wireless Internet	D9-22	2I.05	24 x 24	30 x 30
Weather Information	D12-1	2I.09	84 x 48	132 x 84
Carpool Information	D12-2	2I.11	60 x 42	96 x 66
Channel 9 Monitored	D12-3	2I.09	84 x 48	132 x 84
Emergency Call 911	D12-4	2I.09	66 x 30	96 x 48
Travel Info Call 511 (pictograph)	D12-5	2I.10	42 x 60	66 x 78
Travel Info Call 511	D12-5a	2I.10	48 x 36	66 x 48
 <b>Virginia Specific Signs</b>				
REST AREA PATROLLED BY STATE POLICE	D0-V1	2I.05	48 x 36***	
CALL CELLULAR #77 FOR STATE POLICE	D12-V1	2I.09	36 x 24	60 x 36**** (F) 48 x 30 (E)

\* The size shown is for a sign with a REST AREA and/or TOURIST INFO CENTER legend. The size should be appropriately adjusted if an alternate legend is used.

\*\* The size shown is for a sign with four lines of services. The size should be appropriately adjusted depending on the amount of legend displayed.

\*\*\* This sign shall only be installed within a Rest Area.

\*\*\*\* 102 x 54 sign size may be used in conjunction with R16-4 (V) FENDER BENDER MOVE VEHICLES SIGN.

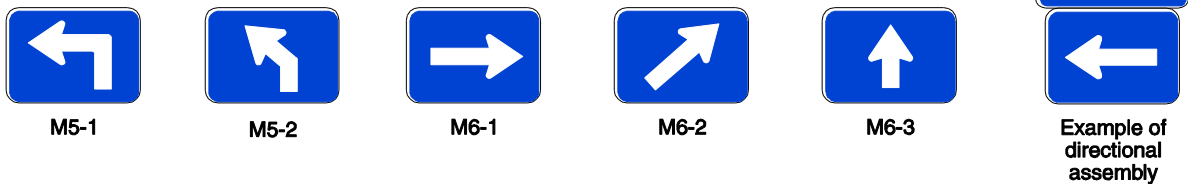
Notes:

1. Larger signs may be used when appropriate.
2. Dimensions in inches are shown as width x height
3. Where two sizes are shown, the larger size is for freeways (F) and the smaller size is for expressways (E)

**Figure 2I-1. General Service Signs and Plaques**



**Advance Turn and Directional Arrow Auxiliary Signs for use with General Service Signs**



- 18 **The phone numbers displayed on the sign shall be the State Police's Division Headquarters toll free number for the area where the rest area/welcome center is located and #77 for cellular phone users.**

Support:

- 19 Further information about Safety Rest Areas and Welcome Centers in Virginia can be found on VDOT's web site (link provided in Appendix A of this Supplement).

## **Section 2I.09 Radio Information Signing**

Option:

- 01 Radio-Weather Information (D12-1) signs (see [Figure 2I-8\(VA\) in this Supplement](#)) may be used in areas where difficult driving conditions commonly result from weather systems. Radio-Traffic Information signs may be used in conjunction with traffic management systems.

**Standard:**

- 02 **Radio-Weather and Radio-Traffic Information signs shall have a white legend and border on a blue background. Only the numerical indication of the radio frequency shall be used to identify a station broadcasting travel-related weather or traffic information. No more than three frequencies shall be displayed on each sign. Only radio stations whose signal will be of value to the road user and who agree to broadcast either of the following two items shall be identified on Radio-Weather and Radio-Traffic Information signs:**
- A. Periodic weather warnings at a rate of at least once every 15 minutes during periods of adverse weather; or**
  - B. Driving condition information (affecting the roadway being traveled) at a rate of at least once every 15 minutes, or when required, during periods of adverse traffic conditions, and when supplied by an official agency having jurisdiction.**
- 03 **If a station to be considered operates only on a seasonal basis, its signs shall be removed or covered during the off season.**

*Guidance:*

- 04 *The radio station should have a signal strength to adequately broadcast 70 miles along the route. Signs should be spaced as needed for each direction of travel at distances determined by an engineering study. The stations to be included on the signs should be selected in cooperation with the association(s) representing major broadcasting stations in the area to provide: (1) maximum coverage to all road users on both AM and FM frequencies; and (2) consideration of 24 hours per day, 7 days per week broadcast capability.*

Option:

- 05 In roadway rest area locations, a smaller sign using a greater number of radio frequencies, but of the same general design, may be used.

### Figure 2I-8(VA). Radio, Telephone, and Carpool Information Signs



D12-1



D12-2



D12-3



D12-4



D12-5\*



D12-5a



D12-V1 

\* The pictograph of the transportation agency or the travel information service or program may be used in place of the 511 pictograph (see Section 2I.08 of the National MUTCD).

**Standard:**

- 06 **Radio-Weather and Radio-Traffic Information signs installed in rest areas shall be positioned such that they are not visible from the main roadway.**

## Option:

- 07 Channel 9 Monitored (D12-3) sign (see [Figure 2I-8\(VA\) in this Supplement](#)) may be installed as needed. Official public agencies or their designees may be displayed as the monitoring agency on the sign.

**Standard:**

- 08 **Only official public agencies or their designee shall be displayed as the monitoring agency on the Channel 9 Monitored sign.**

## Option:

- 09 An Emergency CALL XX (D12-4) sign (see [Figure 2I-8\(VA\) in this Supplement](#)), along with the appropriate number to call, may be used for cellular phone communications.

**Standard:**

- 10 **CALL CELLULAR #77 FOR STATE POLICE (D12-V1) signs (see [Figure 2I-8\(VA\) in this Supplement](#)) shall be installed on Interstate roadways near the State line or, if a roadway does not begin at the State line, near the beginning of the roadway.**
- 11 **D12-V1 signs shall not be installed within the welcome centers and rest areas (refer to [Section 2I.05 in this Supplement](#) for appropriate signing).**

## Option:

- 12 **CALL CELLULAR #77 FOR STATE POLICE (D12-V1) signs may be installed on non-Interstate roadways if requested by Virginia State Police.\***

*Guidance:*

- 1213 *Signs should be installed at 20-mile spacings for rural areas and at reduced spacing in urban areas. The reduced spacing in urban areas should be based on engineering judgment.*

## Support:

- 1314 The location of signs is coordinated between VDOT and the Virginia State Police.

*Guidance:*

- 1415 *CALL CELLULAR # 77 FOR STATE POLICE (D12-V1) signs should be installed with FENDER BENDER MOVE VEHICLES FROM TRAVEL LANES (R16-4, R16-4(V)) signs (see [Section 2B.65 of this Supplement](#)). If used, the two signs should be the same width.*



# CHAPTER 2M. RECREATIONAL AND CULTURAL INTEREST AREA SIGNS

## **Section 2M.08 Placement of Recreational and Cultural Interest Area Symbol Signs**

### **Standard:**

- 01 **If used, recreational and cultural interest area symbol signs shall be placed in accordance with the general requirements contained in Chapter 2A. The symbol(s) shall be placed as sign panels in the uppermost part of the sign and the directional information shall be placed below the symbol(s).**
- 02 **Except as provided in Paragraph 3, if the name of the recreational or cultural interest area facility or activity is displayed on a destination guide sign (see [Section 2M.09 of the MUTCD](#)) and a symbol is used, the symbol shall be placed below the name (see [Figure 2M-2](#)).**

### **Option:**

- 03 When the legend Wildlife Viewing Area is displayed with the RS-076 symbol on a destination guide sign, the symbol may be placed to the left or right of the legend and the arrow may be placed below the symbol (see [Figure 2M-2](#)).
- 04 The symbols displayed with the facility or activity name may be placed below the destination guide sign as illustrated in [Figure 2M-2](#) instead of as sign panels placed with the destination guide sign.
- 05 Secondary symbols of a smaller size (18 x 18 inches) may be placed beneath the primary symbols (see [Drawing A in Figure 2M-1 of the MUTCD](#)), where needed.

### **Standard:**

- 06 **Recreational and cultural interest area symbols installed for non-road use shall be placed in accordance with the general sign position requirements of the authority having jurisdiction.**

### **Support:**

- 07 [Figure 2M-3](#) illustrates typical height and lateral mounting positions. [Figure 2M-4](#) illustrates some examples of the placement of symbol signs within a recreational or cultural interest area. [Figures 2M-5 through 2M-10](#) illustrate some of the symbols that can be used.

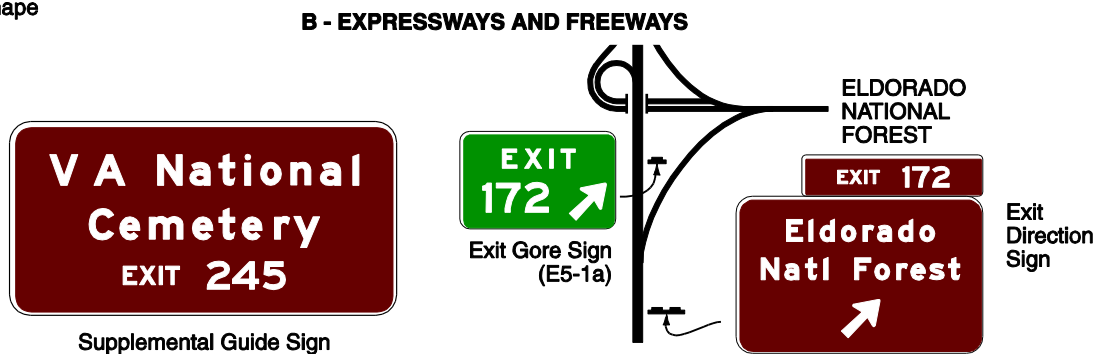
### **Guidance:**

- 08 *The number of symbols used in a single sign assembly should not exceed four.*

**Figure 2M-2 Examples of Recreational and Cultural Interest Area Guide Signs**

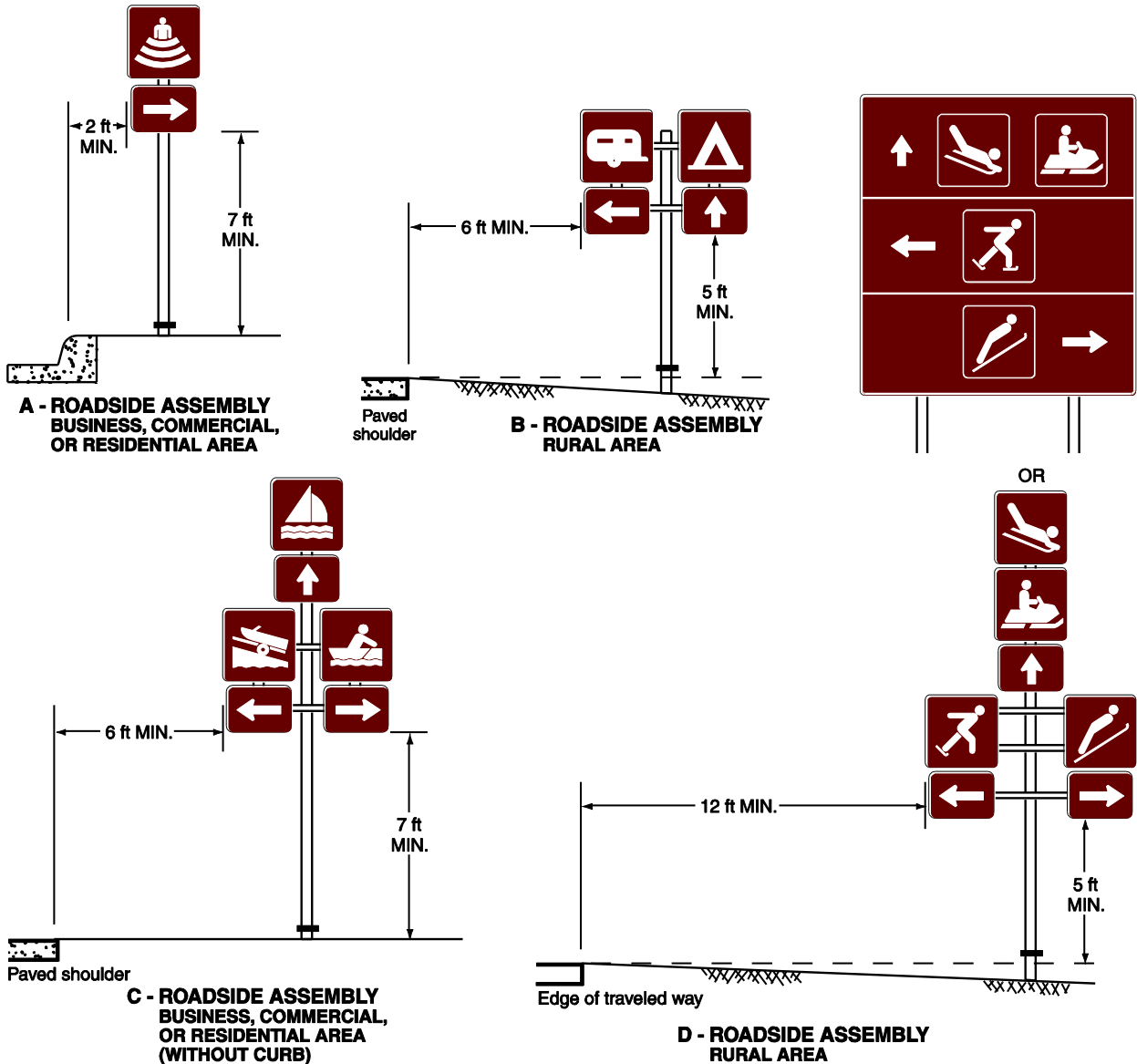


\* Optional shape



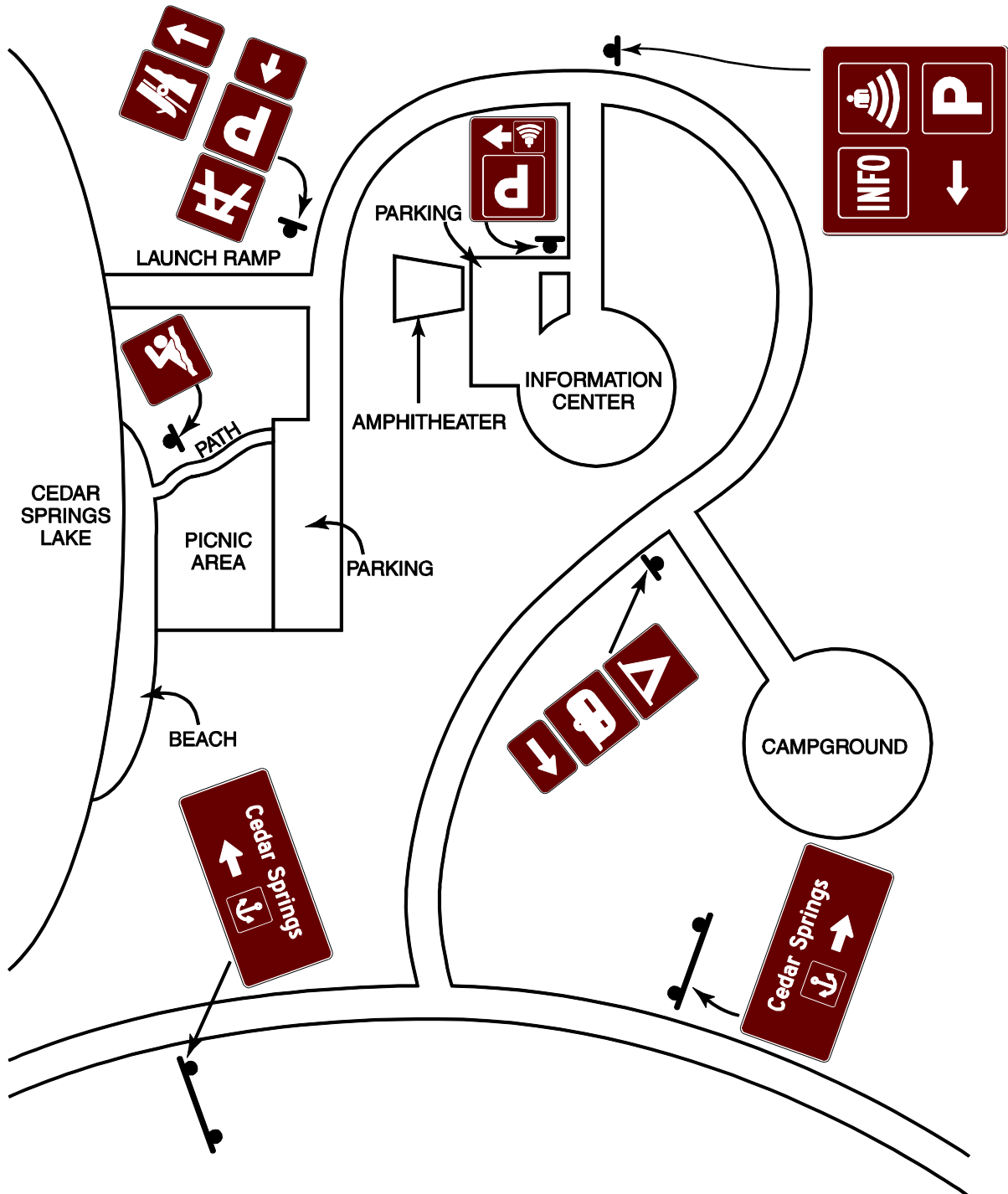


## Figure 2M-3 Arrangement, Height, and Lateral Position of Signs Located Within Recreational and Cultural Interest Areas



Note: See Section 2A.19 for reduced lateral offset distances that may be used in areas where lateral offsets are limited, and in urban areas where sidewalk width is limited or where existing poles are close to the curb.

### Figure 2M-4 Examples of Symbol and Destination Guide Signing Layout



## Figure 2M-5 Recreational and Cultural Interest Area Symbol Signs for General Applications



## Figure 2M-6 Recreational and Cultural Interest Area Symbol Signs for Accommodations



RS-021  
Men's Restroom



RS-022  
Restrooms



RS-023  
Women's Restroom



RS-034  
Parking



RS-037  
Sleeping Shelter



RS-040  
Trailer Site



RS-104  
Recreational Vehicle  
Site



RS-137  
Baby Changing Station  
(Men's Room)



RS-138  
Baby Changing Station  
(Women's Room)



RS-148  
Walk-In Camp

## Figure 2M-7 Recreational and Cultural Interest Area Symbol Signs for Services



**Figure 2M-8 Recreational and Cultural Interest Area Symbol Signs for Land Recreation**



## Figure 2M-9 Recreational and Cultural Interest Area Symbol Signs for Water Recreation



## Figure 2M-10 Recreational and Cultural Interest Area Symbol Signs for Winter Recreation



### Option:

- 09 The Advance Turn (M5 series) or Directional Arrow (M6 series) auxiliary signs with white arrows on brown backgrounds shown in Figure 2D-5 of the MUTCD may be used with Recreational and Cultural Area Interest symbol guide signs to create a Recreational and Cultural Interest Area Directional Assembly. The symbols may be used singularly, or in groups of two, three, or four on a single sign assembly (see Figures 2M-1 of the MUTCD and Figures 2M-3, and 2M-4).

### Option:

- 10 Place of historical interest (I-V12) signs (see Figure 2M-V1 in this Supplement) may be installed within areas of historical interest.

### Support:

- 11 Refer to Section 2M.V1 of this Supplement for Historical Marker signing.
- 12 Refer to Section 2H.04 of this Supplement for Unincorporated Place Name signing.







**Figure 2M-V1. Historical Marker, Place of Historical Interest, and Wayside Signs**

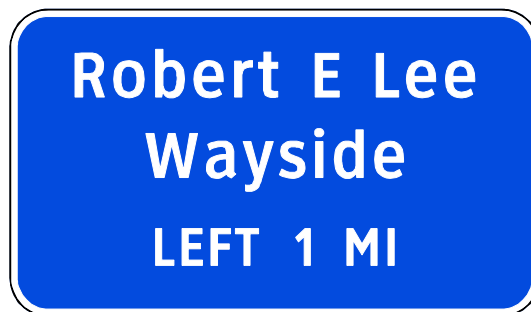


I-V12a



I-V12b

I-V11



I-V14



I-V13

## Section 2M.10 Memorial or Dedication Signing



### Support:

- 01 Virginia's General Assembly and Commonwealth Transportation Board have the authority to adopt an act or resolution memorializing or dedicating a highway, bridge, or other component of a highway. The purpose of the act or resolution is to honor persons or groups who have lost their lives while serving in the armed forces or as officers of the law; or to pay tribute to significant historical events/references. Memorial Facility (I-V2) signs (see Figure 2M-V2 in this Supplement) are installed as a result of such resolutions.

### Guidance:

- 02 *Such memorial or dedication names should not appear on or along a highway, or be placed on bridges or other highway components. If a route, bridge, or highway component is officially designated as a memorial or dedication, and if notification of the memorial or dedication is to be made on the highway right-of-way, such notification should consist of installing a memorial or dedication marker in a rest area, scenic overlook, recreational area, or other appropriate location where parking is provided with the signing inconspicuously located relative to vehicle operations along the highway.*

### Option:

- 03 If the installation of a memorial or dedication marker off the main roadway is not practical, memorial or dedication signs may be installed on the mainline.

### Guidance:

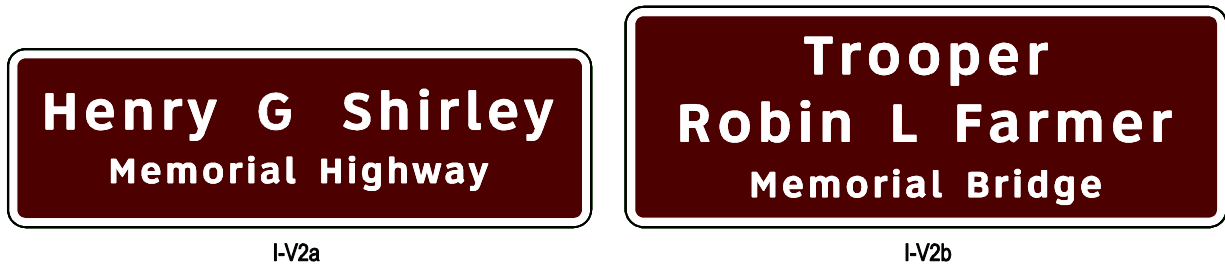
- 04 *Memorial or dedication signs should have a white legend and border on a brown background.*

### Standard:

- 05 **Where such memorial or dedication signs are installed on the mainline, (1) memorial or dedication names shall not appear on directional guide signs, (2) memorial or dedication signs shall not interfere with the placement of any other necessary signing, and (3) memorial or dedication signs shall not compromise the safety or efficiency of traffic flow. The memorial or dedication signing shall be limited to one sign at an appropriate location in each route direction, each as an independent sign installation.**



## Figure 2M-V2. Memorial or Dedication Signing



- 06 **Memorial or dedication signs shall be rectangular in shape. The legend displayed on memorial or dedication signs shall be limited to the name of the person or entity being recognized and a simple message preceding or following the name, such as "Dedicated to" or "Memorial Parkway." Additional legend, such as biographical information, shall not be displayed on memorial or dedication signs. Decorative or graphical elements, pictographs, logos, or symbols shall not be displayed on memorial or dedication signs. All letters and numerals displayed on memorial or dedication signs shall be as provided in the "Standard Highway Signs and Markings" book (see [Section 1A.11 of this Supplement](#)). The route number or officially mapped name of the highway shall not be displayed on the memorial or dedication sign.**

- 07 **Memorial or dedication names shall not appear on supplemental signs or on any other information sign on or along the highway or its intersecting routes.**

**Option:**

- 08 The lettering for the name of the person or entity being recognized may be composed of a combination of lower-case letters with initial upper-case letters.

**Guidance:**

- 09 *Freeways and expressways should not be signed as memorial or dedicated highways.*

**Support:**

- 10 Named highways are officially designated and shown on official maps and serve the purpose of providing route guidance, primarily on unnumbered highways. A highway designated as a memorial or dedication is not considered to be a named highway. [Section 2D.53 of this Supplement](#) contains provisions for the signing of named highways.

**Standard:**

- 11 **Signs shall be kept to a maximum of three lines of text; with up to two lines of variable text and the last line designated for the facility type - Bridge, Memorial Bridge, Highway, Memorial Highway, etc.**
- 12 **On non-limited access conventional roadways, signs shall be no wider than 60 inches and no taller than 18 inches, unless approved by the State Traffic Engineer.**
- 13 **On freeways and expressways, signs shall be no wider than 120 inches and no taller than 36 inches, unless approved by the State Traffic Engineer.**



- 14 ~~Legend context~~The sign legend\* shall comply with Table 2M-V1 in this Supplement.
- 15 Signs shall be posted only for direction of traffic on the facility and shall be limited to one sign at appropriate location in each direction of travel:
- A. On the bridge for crossing, not on under-passing roads;
  - B. On the highway segments or highways, not on approaches/ramps to the named highway or segment.



## Table 2M-V1. Memorial, Recreational, and Cultural Interest Area Sign and Plaque Sizes

Sign or Plaque	Sign Designation	Section	Conventional Road		Expressway	Freeway	Minimum	Oversized
			Single Lane	Multi-Lane				
Named Bridges, Highways & Highways Segments (One Line <sup>***</sup> )	I-V2a	2M.10	Var.* x 12	Var.* x 12	Var.** x 30	Var.** x 30	—	—
Named Bridges, Highways & Highways Segments (Two Lines <sup>***</sup> )	I-V2b	2M.10	Var.* x 18	Var.* x 18	Var.** x 36	Var.** x 36	—	—
HISTORICAL MARKER	I-V11	2M.V1	36 x 24	36 x 24	—	—	—	—
POINT OF HISTORICAL INTEREST (One Line)	I-V12a	2M.08	Var. x 12	Var. x 12	—	—	—	—
POINT OF HISTORICAL INTEREST (Two Lines)	I-V12b	2M.08	Var. x 18	Var. x 18	—	—	—	—
Advance Sign for Wayside	I-V13	2M.V2	Var. x 42	Var. x 42	—	—	—	—
Wayside Identification	I-V14	2M.V2	Var. x 36	Var. x 36	—	—	—	—

\*60 inch maximum\*

\*\*120 inch maximum\*

\*\*\* One Line or Two Lines refers to the name of the highway/bridge, and not to the entire sign, which is either two lines or three lines, respectively (the name, plus the Memorial Highway or Memorial Bridge text).\*



## Section 2M.V1 Advance Signing for Historical Markers (I-V11 signs)

Support:

- 01 The Virginia Department of Historic Resources (DHR) oversees the Historical Marker program, which recognizes sites of historic significance. Information related to the program can be found at Virginia DHR's website. See the Appendix A of this Supplement for the web address.\*

- 01 The Virginia Department of Historic Resources (DHR) oversees the Historical Marker program, which recognizes sites of historic significance. The VDOT Historical Marker Program provides guidance on installation of such markers. Information related to the program is located on the Virginia Historical Highway Markers webpage and DHR's website. See Appendix A of this Supplement for the web addresses.\*

**Standard:**

- 02 **Advance Historical Marker (I-V11) signs (see Figure 2M-V1 in this Supplement) shall only\* be used in advance of Historical Markers where parking has been provided separate from the travelway.**

*Guidance:*

- 03 *Distances on Advance Historical Marker (I-V11) signs should be a multiple of 500 feet multiples of 500 feet. The distance displayed should be 1,000 feet for roadways with posted speed limits 45 mph or greater and 500 feet for roadways with posted speed limits 40 mph or below.\**



## **Section 2M.V2 Signing for Waysides (I-V13 and I-V14 signs)**

*Option:*

- 01 Wayside identification (I-V14) signs (see Figure 2M-V1 in this Supplement) may be installed at established waysides along a roadway.
- 02 Advance Sign for Wayside (I-V13) signs (see Figure 2M-V1 in this Supplement) may be installed in advance of established waysides.

**Standard:**

- 03 **The advance distance in the legend of Advance Sign for Wayside (I-V13) signs shall be a multiple of ½ mile, not exceeding 3 miles.**

## **PART 3. MARKINGS**

### **CHAPTER 3A. GENERAL PAGE**

Section 3A.01 Functions and Limitations	
Section 3A.02 Standardization of Application	
Section 3A.03 Maintaining Minimum Pavement Marking Retroreflectivity	
Section 3A.04 Materials .....	3-1
Section 3A.05 Colors .....	3-1
Section 3A.06 Functions, Widths, and Patterns of Longitudinal Pavement Markings .....	3-2

### **CHAPTER 3B. PAVEMENT AND CURB MARKINGS PAGE**

Section 3B.01 Yellow Center Line Pavement Markings and Warrants .....	3-5
Section 3B.02 No Passing Zone Pavement Markings and Warrants	
Section 3B.03 Other Yellow Longitudinal Pavement Markings	
Section 3B.04 White Lane Line Pavement Markings and Warrants .....	3-10
Section 3B.05 Other White Longitudinal Pavement Markings .....	3-25
Section 3B.06 Edge Line Pavement Markings .....	3-29
Section 3B.07 Warrants for Use of Edge Lines .....	3-30
Section 3B.08 Extensions through Intersections or Interchanges .....	3-31
Section 3B.09 Lane Reduction Transition Markings .....	3-36
Section 3B.10 Approach Markings for Obstructions	
Section 3B.11 Raised Pavement Markers – General .....	3-38
Section 3B.12 Raised Pavement Markers as Vehicle Positioning Guides with Other Longitudinal Markings .....	3-43
Section 3B.13 Raised Pavement Markers Supplementing Other Markings .....	3-44
Section 3B.14 Raised Pavement Markers Substituting for Pavement Markings .....	3-46
Section 3B.15 Transverse Markings	
Section 3B.16 Stop and Yield Lines .....	3-46
Section 3B.17 Do Not Block Intersection Markings	
Section 3B.18 Crosswalk Markings .....	3-49
Section 3B.19 Parking Space Markings .....	3-53
Section 3B.20 Pavement Word, Symbol, and Arrow Markings .....	3-54
Section 3B.21 Speed Measurement Markings .....	3-64
Section 3B.22 Speed Reduction Markings	
Section 3B.23 Curb Markings	
Section 3B.24 Chevron and Diagonal Crosshatch Markings .....	3-66
Section 3B.25 Speed Hump Markings	
Section 3B.26 Advance Speed Hump Markings	



Section 3B.V1 Breaks in Longitudinal Lines at Intersections .....	3-68
---	------

<b>CHAPTER 3C. ROUNDABOUT MARKINGS</b>	<b>PAGE</b>
--	-------------

Section 3C.01 General	
Section 3C.02 White Lane Line Pavement Markings for Roundabouts	
Section 3C.03 Edge Line Pavement Markings for Roundabout Circulatory Roadways	
Section 3C.04 Yield Lines for Roundabouts	
Section 3C.05 Crosswalk Markings at Roundabouts	
Section 3C.06 Word, Symbol, and Arrow Pavement Markings for Roundabouts	
Section 3C.07 Markings for Other Circular Intersections	

<b>CHAPTER 3D. MARKINGS FOR PREFERENTIAL LANES</b>	<b>PAGE</b>
--	-------------

Section 3D.01 Preferential Lane Word and Symbol Markings .....	3-69
Section 3D.02 Preferential Lane Longitudinal Markings for Motor Vehicles .....	3-71

<b>CHAPTER 3E. MARKINGS FOR TOLL PLAZAS</b>	<b>PAGE</b>
---	-------------

Section 3E.01 Markings for Toll Plazas	
--	--

<b>CHAPTER 3F. DELINEATORS</b>	<b>PAGE</b>
--------------------------------	-------------

Section 3F.01 Delineators	
Section 3F.02 Delineator Design .....	3-80
Section 3F.03 Delineator Application .....	3-80
Section 3F.04 Delineator Placement and Spacing .....	3-83

<b>CHAPTER 3G. COLORED PAVEMENTS</b>	<b>PAGE</b>
--------------------------------------	-------------

Section 3G.01 General	
-----------------------	--

<b>CHAPTER 3H. CHANNELIZING DEVICES USED FOR EMPHASIS OF PAVEMENT MARKING PATTERNS</b>	<b>PAGE</b>
--	-------------

Section 3H.01 Channelizing Devices	
------------------------------------	--

<b>CHAPTER 3I. ISLANDS</b>	<b>PAGE</b>
----------------------------	-------------

Section 3I.01 General	
Section 3I.02 Approach End Treatment	
Section 3I.03 Island Marking Application	
Section 3I.04 Island Marking Colors	

Section 3I.05 Island Delineation

Section 3I.06 Pedestrian Islands and Medians

**CHAPTER 3J. RUMBLE STRIP MARKINGS** **PAGE**

---

Section 3J.01 Longitudinal Rumble Strip Markings

Section 3J.02 Transverse Rumble Strip Markings



# PART 3

## MARKINGS

### CHAPTER 3A. GENERAL

#### Section 3A.04 Materials

**Support:**

- 01 Pavement and curb markings are commonly placed by using paints or thermoplastics; however, other suitable marking materials, including raised pavement markers and colored pavements, are also used. Delineators and channelizing devices are visibly placed in a vertical position similar to signs above the roadway.
- 02 Some marking systems consist of clumps or droplets of material with visible open spaces of bare pavement between the material droplets. These marking systems can function in a manner that is similar to the marking systems that completely cover the pavement surface and are suitable for use as pavement markings if they meet the other pavement marking requirements of the highway agency.

**Guidance:**

- 03 *The materials used for markings should provide the specified color throughout their useful life.*
- 04 *Consideration should be given to selecting pavement marking materials that will minimize tripping or loss of traction for road users, including pedestrians, bicyclists, and motorcyclists.*
- 05 *Delineators should not present a vertical or horizontal clearance obstacle for pedestrians.*

**Support:**

- 06 Information regarding the materials used for pavement markings in Virginia can be found in VDOT's latest "Road and Bridge Specifications" ([link provided in Appendix A of this Supplement](#)).



#### Section 3A.05 Colors

**Standard:**

- 01 **Markings shall be yellow, white, red, blue, or purple. The colors for markings shall conform to the standard highway colors. Black in conjunction with one of the colors mentioned in the first sentence of this paragraph shall be a usable color.**
- 02 **When used, white markings for longitudinal lines shall delineate:**
  - A. **The separation of traffic flows in the same direction, or**
  - B. **The right-hand edge of the roadway.**

- 03 **When used, yellow markings for longitudinal lines shall delineate:**
- A. **The separation of traffic traveling in opposite directions,**
  - B. **The left-hand edge of the roadways of divided highways and one-way streets or ramps, or**
  - C. **The separation of two-way left-turn lanes and reversible lanes from other lanes.**
- 04 **When used, red raised pavement markers or delineators shall delineate:**
- A. **Truck escape ramps, or**
  - B. **One-way roadways, ramps, or travel lanes that shall not be entered or used in the direction from which the markers are visible.**
- 05 **When used, blue markings shall supplement white markings for parking spaces for persons with disabilities.**
- 06 **When used, purple markings shall supplement lane line or edge line markings for toll plaza approach lanes that are restricted to use only by vehicles with registered electronic toll collection accounts.**

Option:

- 07 Colors used for official route shield signs (see [Section 2D.11 of this Supplement](#)) may be used as colors of symbol markings to simulate route shields on the pavement (see [Section 3B.20 of this Supplement](#)).

**Standard:**

- 08 **Black shall be used in combination with the colors mentioned in the first sentence of Paragraph 1 where sufficient contrast is not present between the pavement surface and the markings.\***

*Guidance:*

- 08 *The use of non-reflective black in combination with the colors mentioned in the first sentence of Paragraph 1, particularly with white markings, should be considered for concrete bridges and concrete pavement sections more than 75 feet in length with a posted speed limit of 25 mph or greater.\**

Option:

- 09 When used with broken white lines, the black may be used in one of two ways to help improve contrast:\*
- A. As an outline around the white markings, or\*
  - B. In an alternating pattern with the white markings\*.

Support:

- 0910 When used in combination with other colors, black is not considered a marking color, but only a contrast-enhancing system for the markings.

## Section 3A.06 Functions, Widths, and Patterns of Longitudinal Pavement Markings

### Standard:

- 01 The general functions of longitudinal lines shall be:
- A. A double line indicates maximum or special restrictions,
  - B. A solid line discourages or prohibits crossing (depending on the specific application),
  - C. A broken line indicates a permissive condition, and
  - D. A dotted line provides guidance or warning of a downstream change in lane function.
- 02 The widths and patterns of longitudinal lines shall be as follows:
- A. Normal line—4 inches wide, except as provided in Paragraphs 9 through 11 below.
  - B. Wide line—~~at least~~ twice the width of a normal line.
  - C. Double line—two parallel lines separated by a discernible space.
  - D. Broken line—normal line segments separated by gaps.
  - E. Dotted line—noticeably shorter line segments separated by shorter gaps than used for a broken line. The width of a dotted line extension shall be at least the same as the width of the line it extends.
- 03 Broken lines shall consist of 10-foot line segments and 30-foot gaps.
- 04 A dotted line for line extensions or taper areas at an intersection shall consist of 2-foot line segments and 4-foot gaps. A dotted line used for lane drop markings at intersections shall consist of 3-foot line segments and 9-foot gaps.
- Guidance:* \*
- 05 A dotted line used as a lane line at interchanges ~~should~~ ~~shall~~\* consist of 3-foot line segments and 9-foot gaps
- Guidance:* \*
- 06 The space between two parallel lines should be a minimum of 4 inches wide and should be no less than 6 inches wide if raised pavement markers are present. Prior to installing new parallel lines, the need for raised pavement markers in the near future (e.g., prior to the next scheduled resurfacing) should be investigated to identify the most appropriate spacing that would also accommodate future installation of raised pavement markers.
- Support:
- 07 The width of the line indicates the degree of emphasis.
- 08 Patterns for dotted lines depend on the application (see Sections 3B.04 and 3B.08 of this Supplement.)



**Standard:**

- 09 **The through lanes of all freeways shall be marked with 6-inch wide normal lines except as noted in Paragraph 10. When using normal line pavement markings on such highways, all normal line markings, including lane lines and edge lines, shall be 6 inches wide.**

*Guidance:*

- 10 *The through lanes of other limited access highways should be marked with 6-inch wide normal lines except those short segments (approximately three miles or less) of limited access primary routes designed to take traffic around communities and built-up areas, unless the connecting non-limited access portions of that route are also marked with 6-inch wide traffic lines.*

**Option:**

- 11 Any other roadway or roadway segment, including ramps and loops, may be marked with 6-inch wide normal lane markings based upon engineering judgment.\* Roadways with travel lane widths less than 12 feet in width may be evaluated by the Engineer on a case-by-case basis to determine the appropriate pavement marking width.\*

## CHAPTER 3B. PAVEMENT AND CURB MARKINGS

### Section 3B.01 Yellow Center Line Pavement Markings and Warrants

**Standard:**

- 01 **Center line pavement markings, when used, shall be the pavement markings used to delineate the separation of traffic lanes that have opposite directions of travel on a roadway and shall be yellow.**

**Option:**

- 02 Center line pavement markings may be placed at a location that is not the geometric center of the roadway.
- 03 On roadways without continuous center line pavement markings, short sections may be marked with center line pavement markings to control the position of traffic at specific locations, such as around curves, over hills, on approaches to grade crossings, at grade crossings, and at bridges.

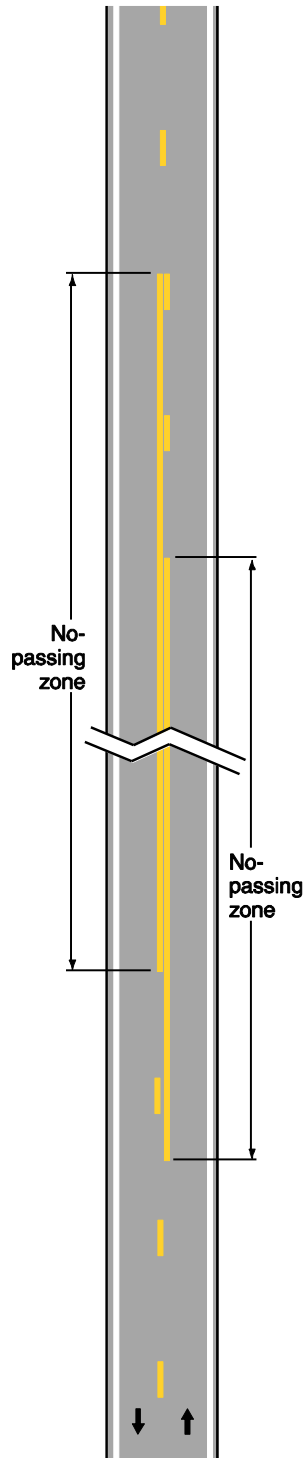
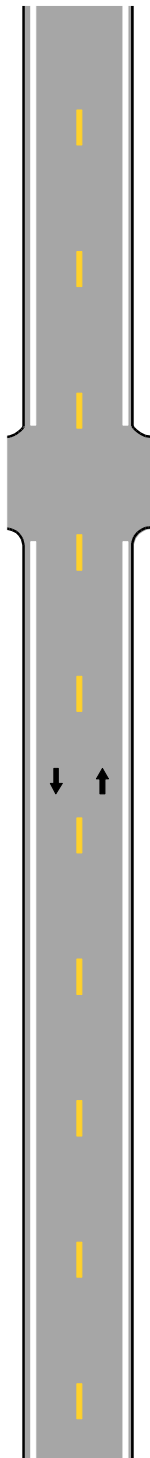
**Standard:**

- 04 **The center line markings on two-lane, two-way roadways shall be one of the following as shown in Figure 3B-1:**
- A. **Two-direction passing zone markings consisting of a normal broken yellow line where crossing the center line markings for passing with care is permitted for traffic traveling in either direction;**
  - B. **One-direction no-passing zone markings consisting of a double yellow line, one of which is a normal broken yellow line and the other is a normal solid yellow line, where crossing the center line markings for passing with care is permitted for the traffic traveling adjacent to the broken line, but is prohibited for traffic traveling adjacent to the solid line; or**
  - C. **Two-direction no-passing zone markings consisting of two normal solid yellow lines where crossing the center line markings for passing is prohibited for traffic traveling in either direction.**
- 05 **A single solid yellow line shall not be used as a center line marking on a two-way roadway.**
- 06 **The center line markings on undivided two-way roadways with four or more lanes for moving motor vehicle traffic always available shall be the two-direction no-passing zone markings consisting of a solid double yellow line as shown in Figure 3B-2.**

# Figure 3B-1. Examples of Two-Lane, Two-Way Marking Applications

**A - Typical two-lane, two-way marking with passing permitted in both directions**

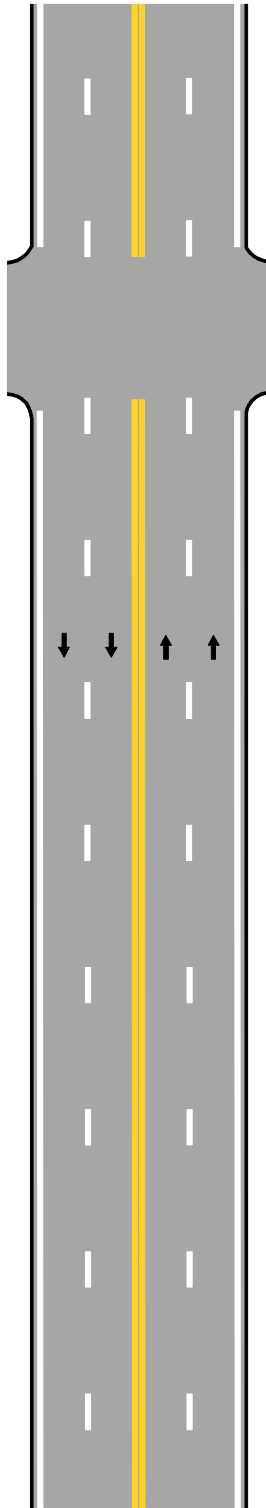
**B - Typical two-lane, two-way marking with no-passing zones**



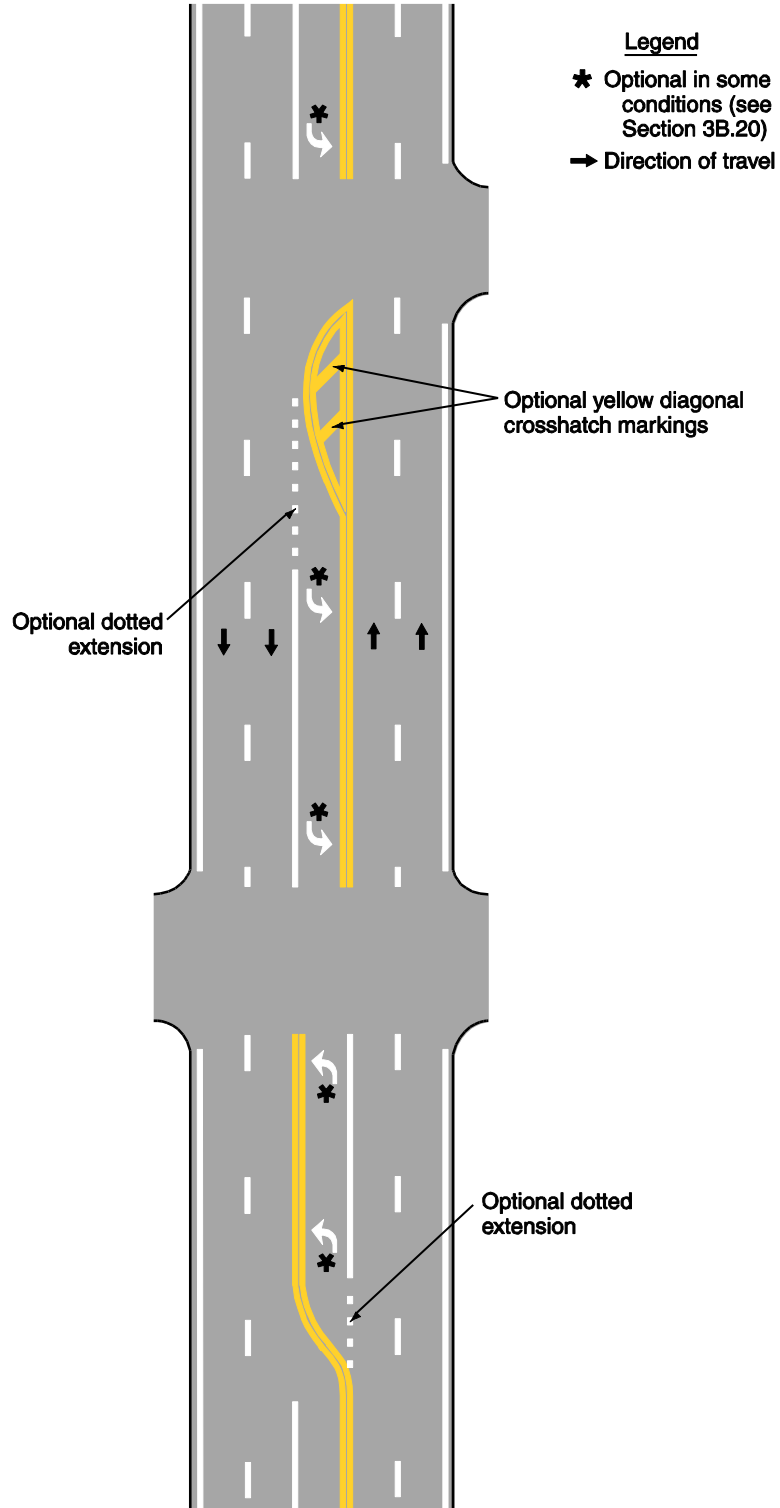
Legend  
→ Direction of travel

### Figure 3B-2. Examples of Four-or-More Lane, Two-Way Marking Applications

**A - Typical multi-lane, two-way marking**



**B - Typical multi-lane, two-way marking with single lane left turn channelization**



*Guidance:*

- 07 *On two-way roadways with three through lanes for moving motor vehicle traffic, two lanes should be designated for traffic in one direction by using one- or two-direction no-passing zone markings as shown in Figure 3B-3.*

*Support:*

- 08 Sections 11-301(c) and 11-311(c) of the "Uniform Vehicle Code (UVC)" contain information regarding left turns across center line no-passing zone markings and paved medians, respectively. The UVC can be obtained from the National Committee on Uniform Traffic Laws and Ordinances at the address shown on [Page i of the MUTCD](#).

**Standard:**

- 09 ~~Breaks in center line markings shall be made only at intersections with public roads. Breaks shall be of sufficient length to accommodate traffic entering and leaving the side road. If a segment of roadway containing an intersection is marked with two-direction phasing zone markings (see Paragraph 4) on one or both sides of the intersection, one-direction no-passing zone markings (see Paragraph 4) shall be used within 335 feet of the intersection to prohibit passing in the direction approaching the intersection.\*~~

*Guidance:*

- 09 *Breaks in center line markings should be made only at intersections with public roads, where the minor street has center line markings. Breaks should be of sufficient length to accommodate traffic entering or leaving the minor street.\**

*Option:*

- 10 *Breaks may be omitted in locations where the center line markings are needed for additional emphasis or delineation of the travel lanes, such as offset intersections or intersections located on horizontal or vertical curves.\**

*Guidance:*

- 1011 *Breaks in center line markings should not be provided for low-volume public roadways or\* private road entrances.*

- 12 *If a segment of roadway containing an intersection with the conditions described in Paragraph 9\* is marked with two-direction passing zone markings (see Paragraph 4) on one or both sides of the intersection, one-direction no passing zone markings should\* be placed in the vicinity\* of the intersection to prohibit passing in the direction approaching the intersection.*

**Standard:**

- 1113 ~~Center line markings shall be placed on all paved urban arterials and collectors that have a traveled way of 20 feet or more in width and an ADT of 6,000 vehicles per day or greater. Center line markings shall also be placed on all paved two-way streets or highways that have three or more lanes for moving motor vehicle traffic.~~

*Guidance:*

- 1214 *Center line markings should be placed on paved urban arterials and collectors that have a traveled way of 20 feet or more in width and an ADT of 4,000 vehicles per day or greater. Center line markings should also be placed on all rural arterials and collectors*



*that have a traveled way of 18 feet or more in width and an ADT of 3,000 vehicles per day or greater. Center line markings should also be placed on other traveled ways where an engineering study indicates such a need.*

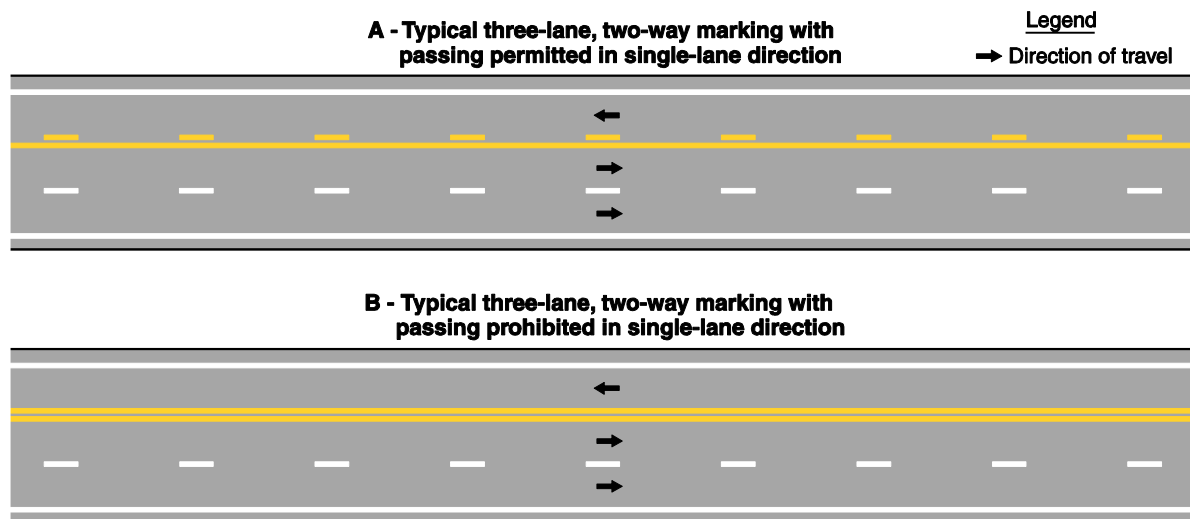
**1315** Engineering judgment should be used in determining whether to place center line markings on traveled ways that are less than 18 feet wide because of the potential for traffic encroaching on the pavement edges, traffic being affected by parked vehicles, and traffic encroaching into the opposing traffic lane.

Option:

**1416** ~~Center line markings may be placed on other paved two-way traveled ways that are 16 feet or more in width.~~

**1517** If a traffic count is not available, the ADTs described in this Section may be estimates that are based on engineering judgment.

### Figure 3B-3. Example of Three-Lane, Two-Way Marking Applications



#### Standard:

**1618** Except on local residential streets, center line markings shall be placed on each of the following:

- A. All undivided limited access highways;
- B. All bi-directional multi-lane roadways; and
- C. All other paved roadways with a pavement width of 18 feet or greater, and traffic volume equal to or greater than 500 vehicles per day.



**Support:**

1719 Center line pavement markings are required on these roadway types according to the 1994 House Joint Resolution # 243.

**Guidance:**

1820 *If a section of roadway requires center line markings, but it contains a relatively short segment that does not meet the requirements above, center line markings should be installed on the short segment for consistency.*

**Option:**

1921 Center line pavement markings may be placed on roadways satisfying Criterion C in Paragraph 16 18\* above, but with fewer than 500 vehicles per day, if an engineering study determines that vehicle speeds, crash frequency, or other factors indicate that a center line is warranted.

**Support:**

22 Criteria for placement of center line markings are shown in Table 3B-V1.\*



## Table 3B-V1. Criteria For Placement of Center Line Markings\*

(This Table has been added to the Virginia Supplement to the MUTCD – Revision 1.)\*

Pavement Width	Traffic Volume	Roadway Type				
		Undivided Limited Access	Bi-Directional Multi-Lane	Other Non-Local Residential	Other Local Residential	Short Segments not Meeting Requirements Between Segments Meeting Requirements
≥ 18 feet	≥ 500 vpd	Required	Required	Required	Optional	Recommended
	< 500 vpd	Required	Required	Optional (if warranted)	Optional	Recommended
< 18 feet	≥ 500 vpd	Required	Required	May be considered only where Engineering Judgment determines a need		Recommended
	< 500 vpd	Required	Required			Recommended

## Section 3B.04 White Lane Line Pavement Markings and Warrants

**Standard:**

- 01 When used, lane line pavement markings delineating the separation of traffic lanes that have the same direction of travel shall be white.
- 02 Lane line markings shall be used on all freeways and interstate highways.

*Guidance:*

- 03 *Lane line markings should be used on all roadways that are intended to operate with two or more adjacent traffic lanes in the same direction of travel, except as otherwise required for reversible lanes. Lane line markings should also be used at congested locations where the roadway will accommodate more traffic lanes with lane line markings than without the markings.*

**Standard:**

- 04 **Except as provided in Paragraph 5, where crossing the lane line markings with care is permitted, the lane line markings shall consist of a normal broken white line.**
- 05 **A dotted white line marking shall be used as the lane line to separate a through lane that continues beyond the interchange or intersection from an adjacent lane for any of the following conditions:**
- A. **A deceleration or acceleration lane,**
  - B. **A through lane that becomes a mandatory exit or turn lane,**
  - C. **An auxiliary lane 2 miles or less in length between an entrance ramp and an exit ramp, or**
  - D. **An auxiliary lane 1 mile or less in length between two adjacent intersections.**

*Guidance:*

- 06 *For exit ramps, lane drops, and route splits, except in the case of tapered deceleration lanes, ~~a wide~~ an 8-inch minimum\* solid white lane line should be installed upstream of the theoretical gore for a minimum length of 100 feet (see Drawings A and C of Figure 3B-8(VA) and all Drawings of Figure 3B-10(VA) in this Supplement).*
- 07 *For multi-lane exit ramps, ~~a wide~~ an 8-inch minimum\* solid white lane line marking should be installed upstream of the theoretical gore for a minimum length of 100 feet and should extend onto the ramp to the physical gore (see Drawing C of Figure 3B-8(VA) and Drawing B of Figure 3B-10(VA) in this Supplement).*

**Option:**

- 08 The length of the solid white line separating multiple lanes of an exit ramp (see Drawing B of Figure 3B-10(VA) in this Supplement) may be greater than 100 feet on the through lane section and may extend beyond the physical gore on the ramp based on engineering judgment.
- 09 For exit ramps with a tapered deceleration lane, a normal width dotted lane line may be installed from the upstream end of the taper to the theoretical gore, as shown in Drawing B of Figure 3B-8(VA) in this Supplement.

**Option:**

- 10 The length of the ~~wide~~ 8-inch minimum\* solid white lane line may be greater than 100 feet based on engineering judgment.

**Standard:**

- 11 **For exit ramps with a parallel deceleration lane, a normal width dotted white lane line shall be installed from the upstream end of the taper to the upstream end of the**

**~~wide~~8-inch minimum\* solid white lane line (see Drawings A and C of Figure 3B-8(VA) in this Supplement).**

*Guidance:*

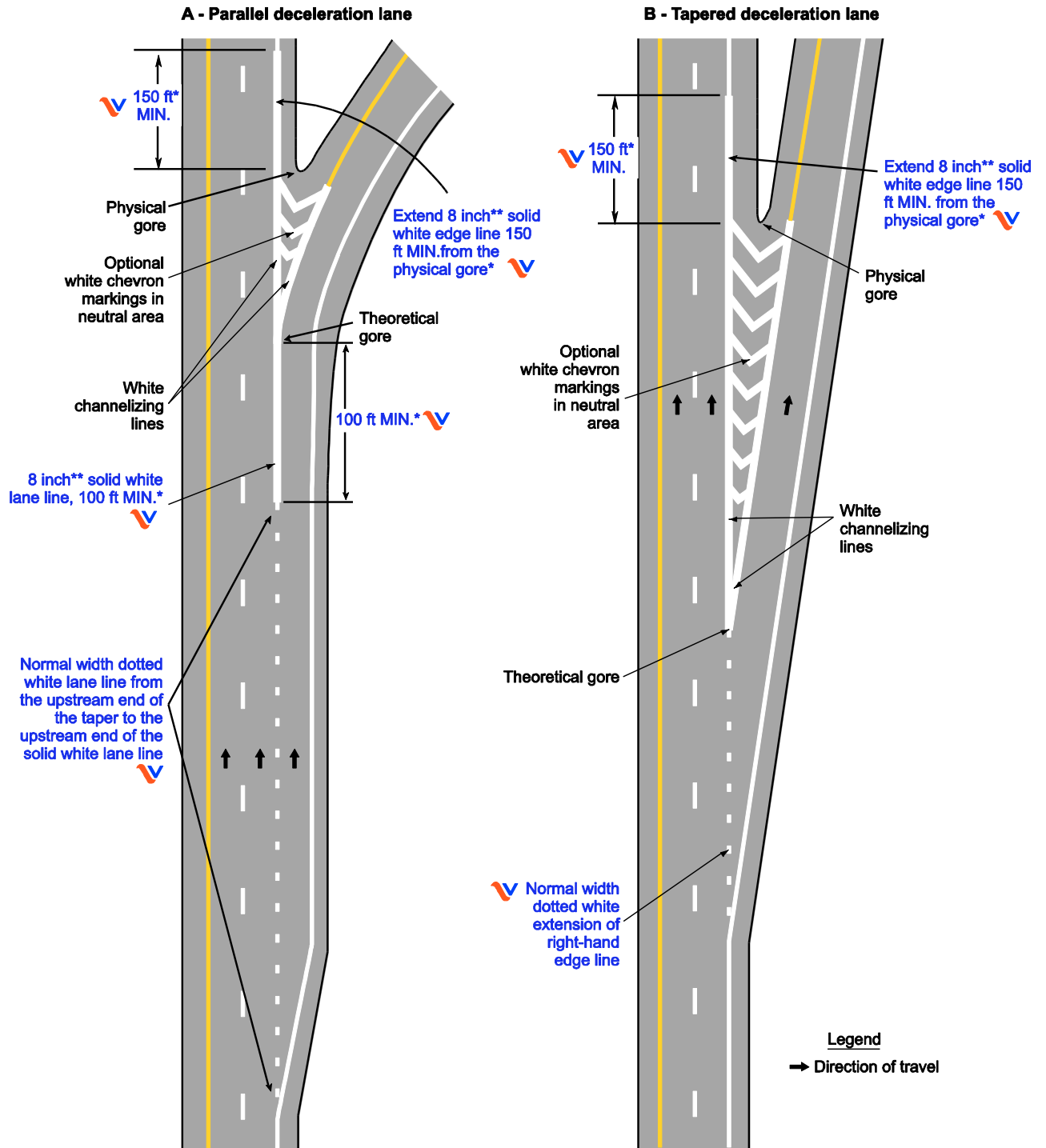
- 12 *For exit ramps or major route bifurcations, ~~a wide an 8-inch minimum\*~~ solid white edge line downstream of the gore area should be installed a minimum of 150 feet beyond the physical gore (see Drawings A, B, and C of Figure 3B-8(VA) and Figure 3B-10(VA) in this Supplement).*
- 13 *For entrance ramps with a parallel acceleration lane, ~~a wide an 8-inch minimum\*~~ solid white lane line should be installed downstream of the theoretical gore for a minimum of 100 feet (see Drawing A of Figure 3B-9(VA) in this Supplement).*

**Standard:**

- 14 **For entrance ramps with a parallel acceleration lane, a normal width dotted white lane line shall be installed from the downstream end of the ~~wide~~8-inch minimum\* solid white lane line to a point at least one-half the length of the full-width acceleration lane plus taper (see Drawing A of Figure 3B-9(VA) in this Supplement).**

### Figure 3B-8(VA). Example of Dotted Line and Channelizing Line Applications for Exit Ramp Markings (Sheet 1 of 2)

(This Figure has been updated for the Virginia Supplement to the MUTCD – Revision 1.)\*



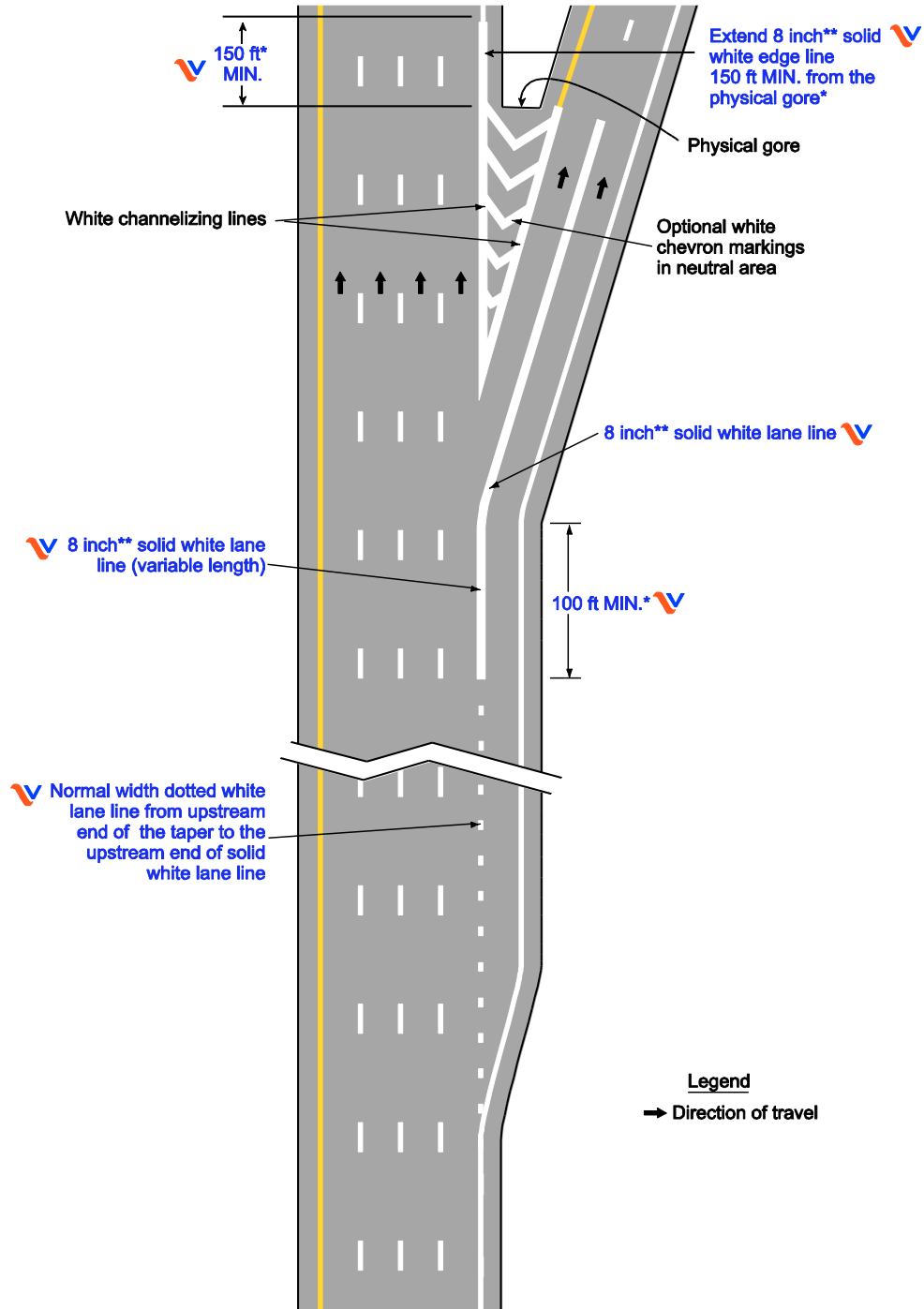
\*Minimums are recommended distances where spacing allows or is feasible

\*\*For all thicker emphasis lines in gore and lane drop areas, the width shall be 8 inches minimum.

## Figure 3B-8(VA). Example of Dotted Line and Channelizing Line Applications for Exit Ramp Markings (Sheet 2 of 2)

(This Figure has been updated for the Virginia Supplement to the MUTCD – Revision 1.)\*

C – Parallel deceleration lane at a multi-lane exit ramp having an optional exit lane that also carries the through route

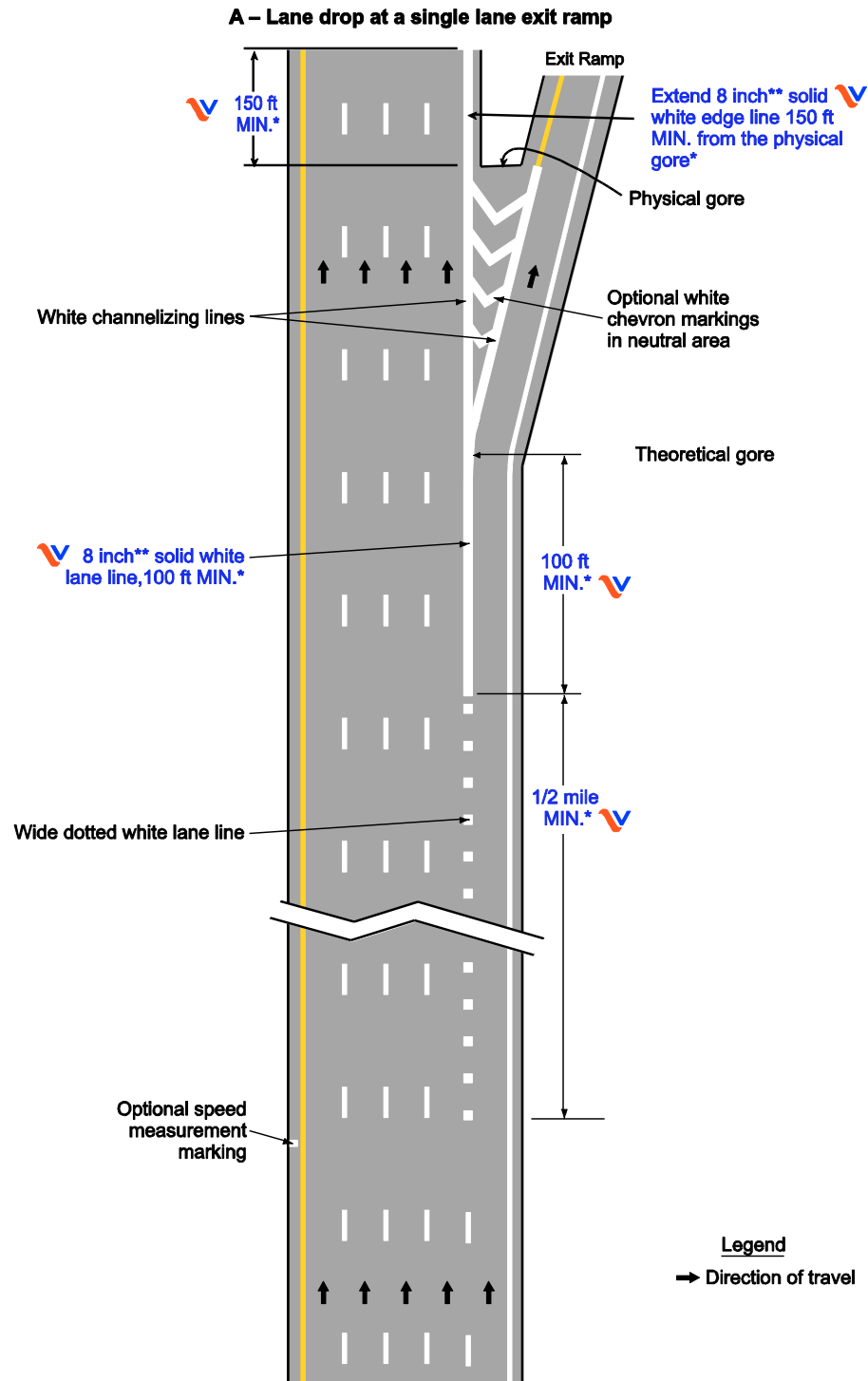


\*Minimums are recommended distances where spacing allows or is feasible

\*\*For all thicker emphasis lines in gore and lane drop areas, the width shall be 8 inches minimum.

## Figure 3B-10(VA). Examples of Applications of Freeway and Expressway Lane-Drop Markings (Sheet 1 of 5)

(This Figure has been updated for the Virginia Supplement to the MUTCD – Revision 1.)\*

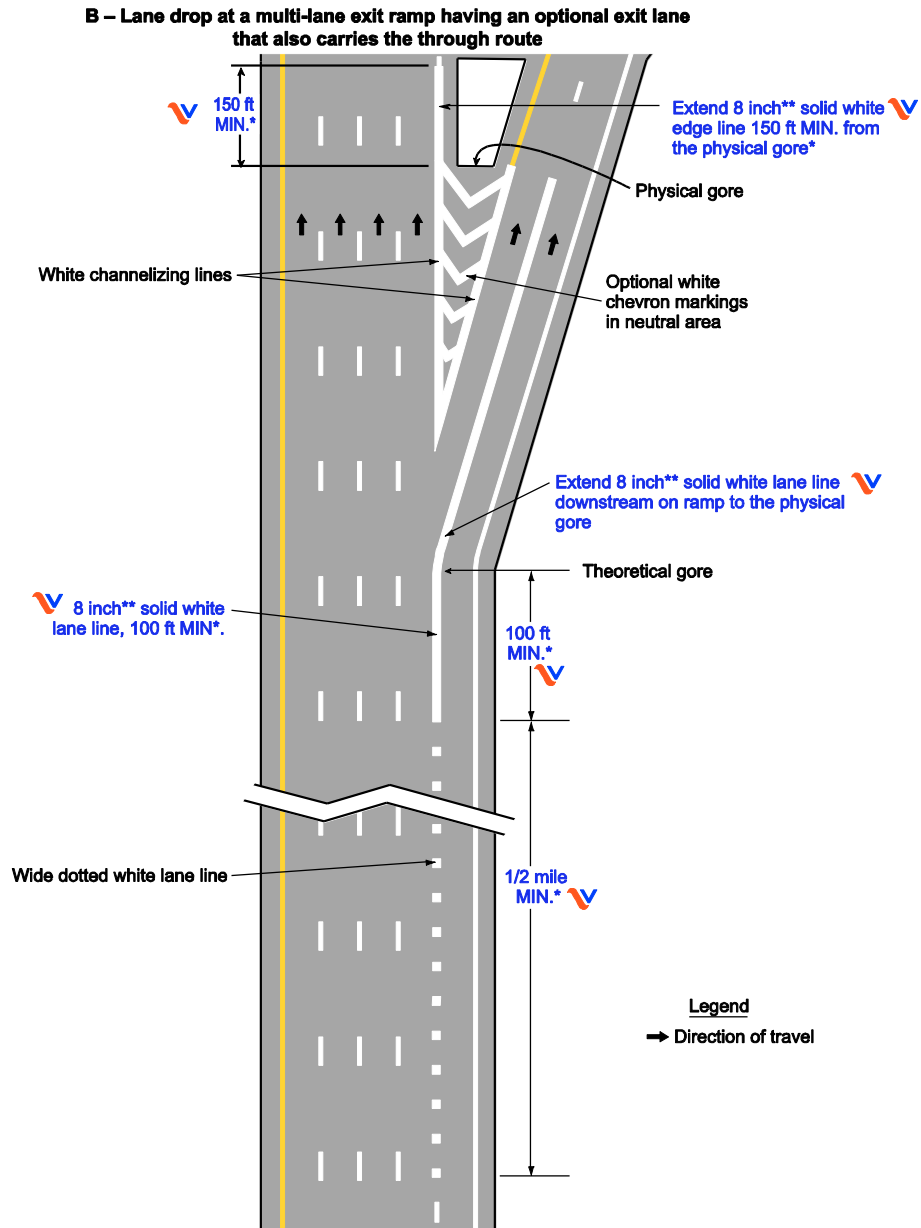


\*Minimums are recommended distances where spacing allows or is feasible

\*\*For all thicker emphasis lines in gore and lane drop areas, the width shall be 8 inches minimum.

## Figure 3B-10(VA). Examples of Applications of Freeway and Expressway Lane-Drop Markings (Sheet 2 of 5)

(This Figure has been updated for the Virginia Supplement to the MUTCD – Revision 1.)\*



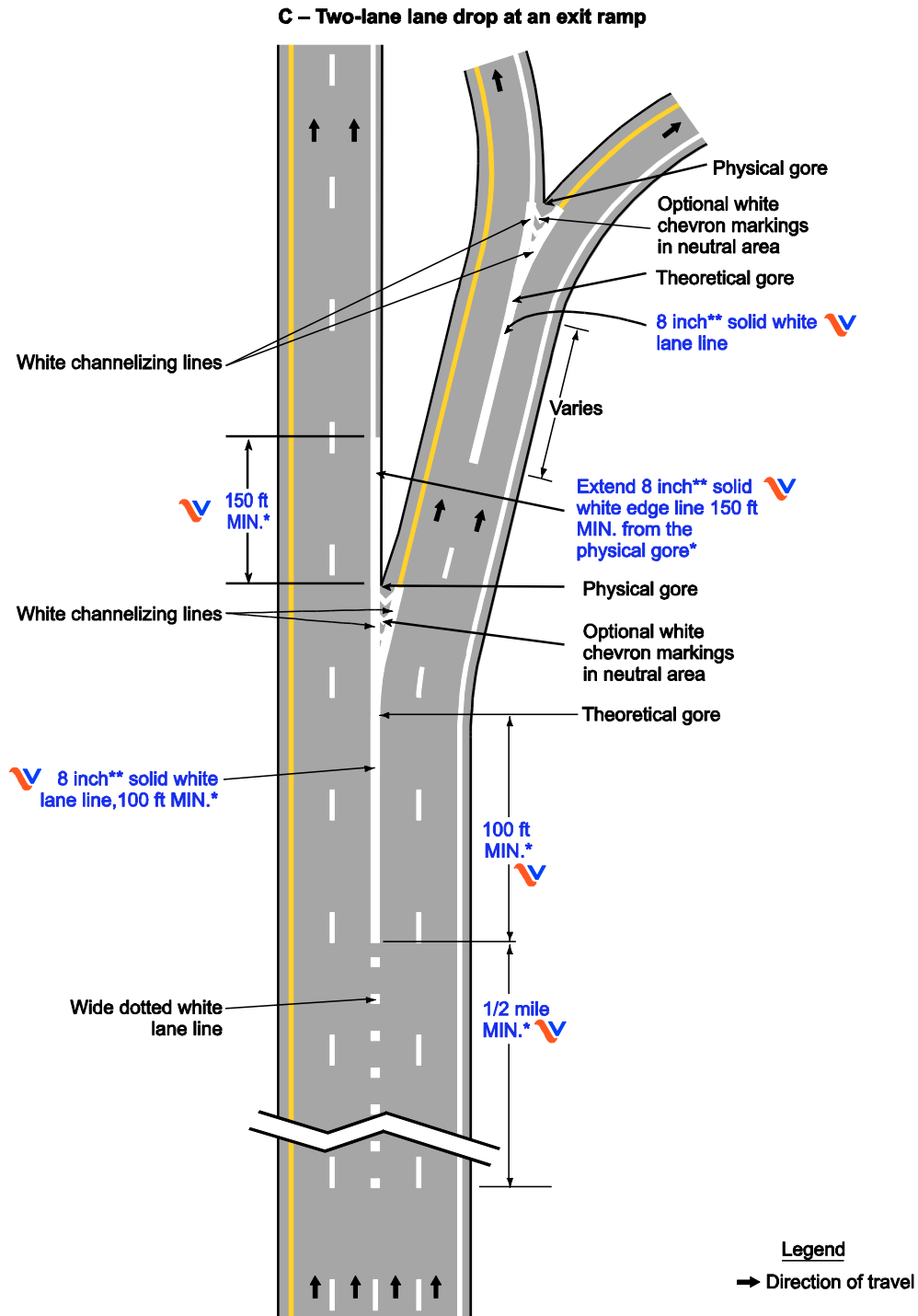
\*Minimums are recommended distances where spacing allows or is feasible

\*\*For all thicker emphasis lines in gore and lane drop areas, the width shall be 8 inches minimum.



## Figure 3B-10(VA). Examples of Applications of Freeway and Expressway Lane-Drop Markings (Sheet 3 of 5)

(This Figure has been updated for the Virginia Supplement to the MUTCD – Revision 1.)\*

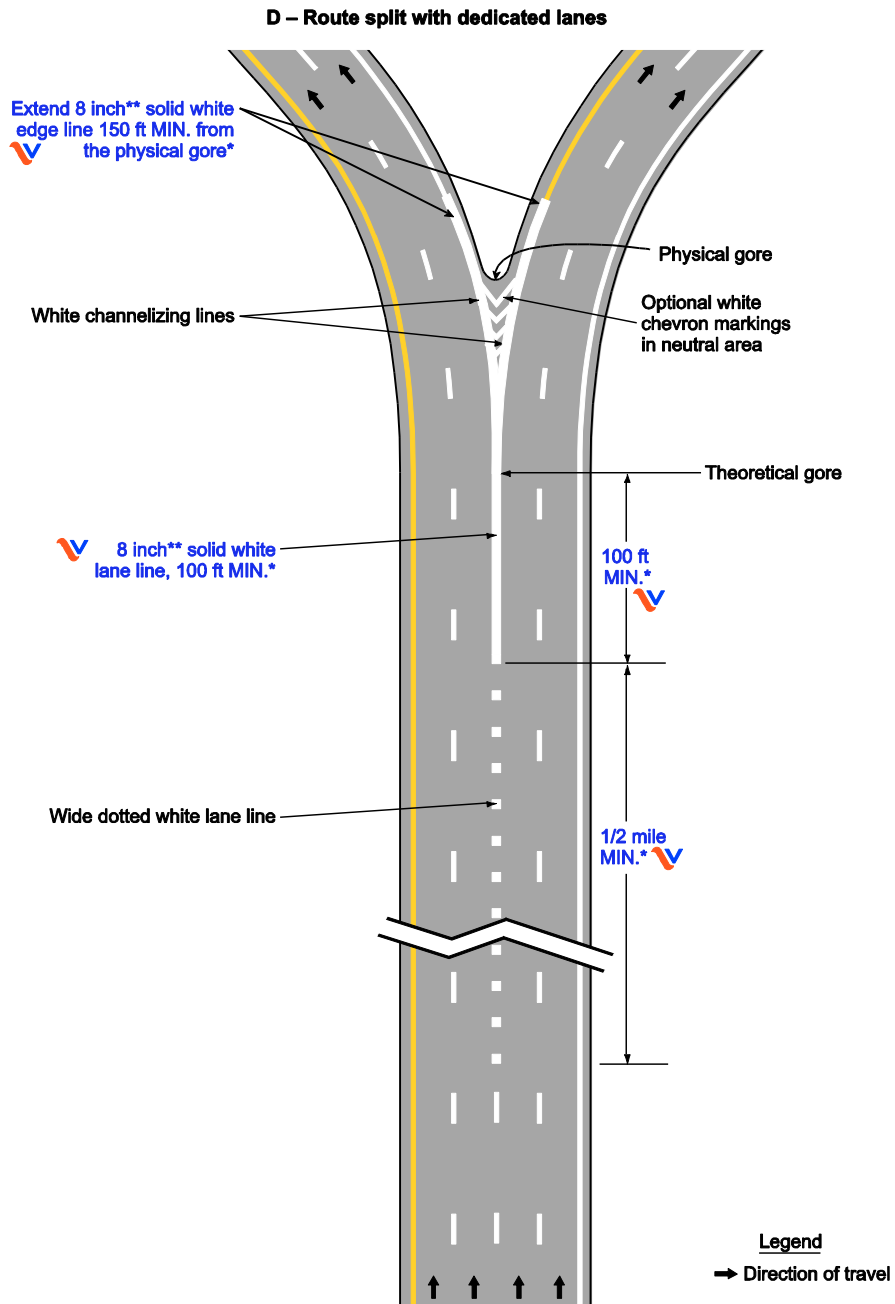


\*Minimums are recommended distances where spacing allows or is feasible

\*\*For all thicker emphasis lines in gore and lane drop areas, the width shall be 8 inches minimum.

## Figure 3B-10(VA). Examples of Applications of Freeway and Expressway Lane-Drop Markings (Sheet 4 of 5)

(This Figure has been updated for the Virginia Supplement to the MUTCD – Revision 1.)\*

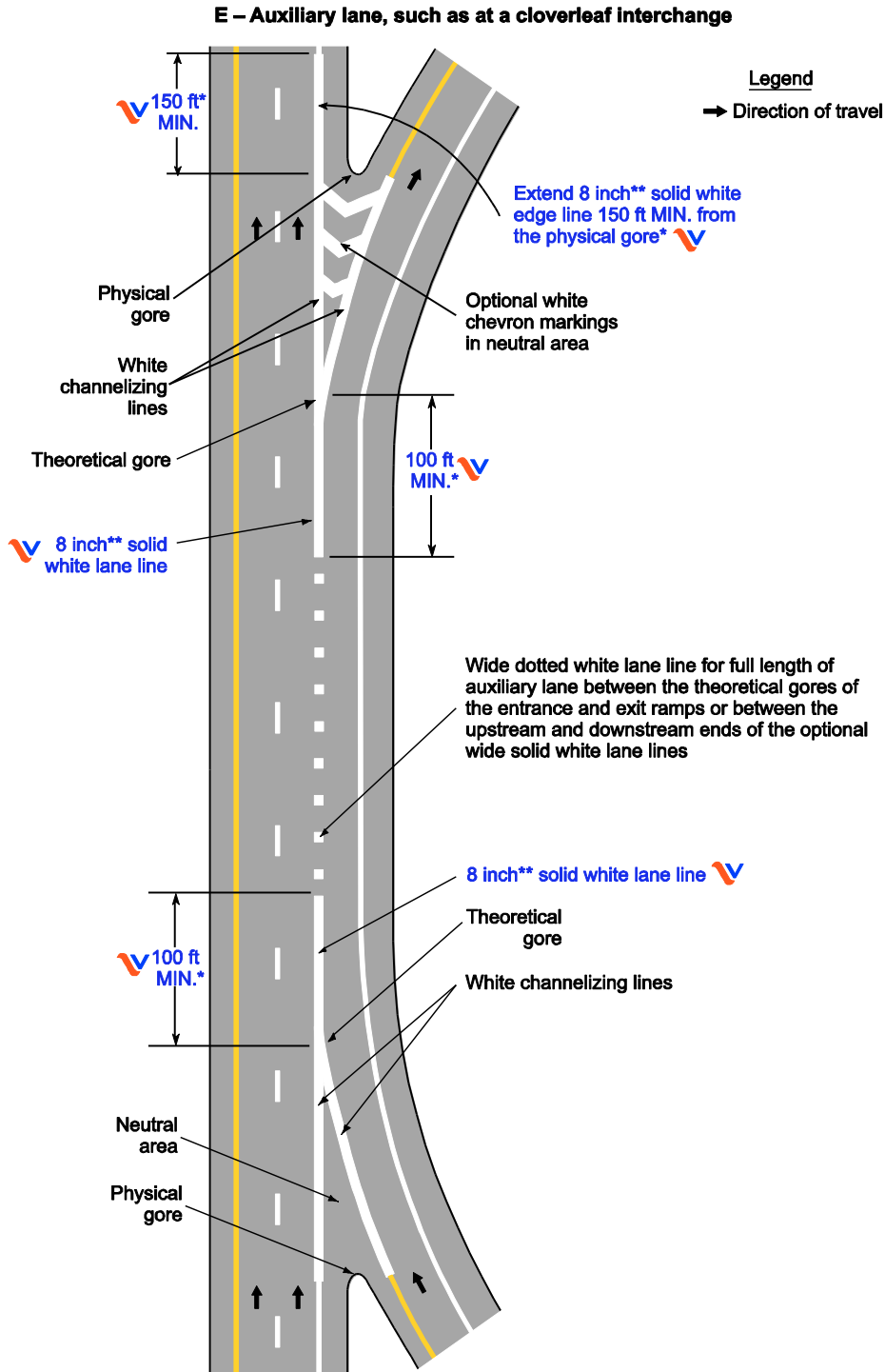


\*Minimums are recommended distances where spacing allows or is feasible

\*\*For all thicker emphasis lines in gore and lane drop areas, the width shall be 8 inches minimum.

## Figure 3B-10(VA). Examples of Applications of Freeway and Expressway Lane-Drop Markings (Sheet 5 of 5)

(This Figure has been updated for the Virginia Supplement to the MUTCD – Revision 1.)\*



\*Minimums are recommended distances where spacing allows or is feasible

\*\*For all thicker emphasis lines in gore and lane drop areas, the width shall be 8 inches minimum.

**Option:**

- 15 The length of the **wide 8-inch minimum\*** solid white lane line may be greater than 100 feet based on engineering judgment.

**Standard:**

- 16 **A wide dotted white lane line shall be used:**
- A. As a lane drop marking in advance of lane drops at exit ramps to distinguish a lane drop from a normal exit ramp (see Drawings A, B, and C of Figure 3B-10(VA) in this Supplement),
  - B. In advance of freeway route splits with dedicated lanes (see Drawing D of Figure 3B-10(VA) in this Supplement),
  - C. To separate a through lane that continues beyond an interchange from an adjacent auxiliary lane between an entrance ramp and an exit ramp, (see Drawing E of Figure 3B-10(VA) in this Supplement),
  - D. As a lane drop marking in advance of lane drops at intersections to distinguish a lane drop from an intersection through lane (see Drawing A of Figure 3B-11(VA) in this Supplement), and
  - E. To separate a through lane that continues beyond an intersection from an adjacent auxiliary lane between two intersections (see Drawing B of Figure 3B-11(VA) in this Supplement).

**Guidance:**

- 17 *On the approach to a multi-lane exit ramp having an optional exit lane that also carries through traffic, lane line markings should be used as illustrated in Drawing B of Figure 3B-10(VA) in this Supplement. In this case, if the right-most exit lane is an added lane such as a parallel deceleration lane, the lane drop marking should begin at the upstream end of the full-width deceleration lane, as shown in Drawing C of Figure 3B-8(VA) in this Supplement.*
- 18 *Lane drop markings used in advance of lane drops at freeway and expressway exit ramps should begin at least 1/2 mile in advance of the **wide 8-inch minimum\*** solid white lane line.*
- 19 *The dotted white lane lines that are used for lane drop markings and that are used as a lane line separating through lanes from auxiliary lanes should consist of line segments that are 3 feet in length separated by 9-foot gaps.*

**Standard:**

- 20 **On the approach to a multi-lane exit ramp having a lane drop condition and an optional exit lane that also carries through traffic, a **wide 8-inch minimum\*** white lane line marking shall be used to separate the drop lane from the optional exit lane.**
- 21 **On the approach to a multi-lane exit ramp having an additional tapered parallel deceleration lane and an optional exit lane that also carries through traffic, a **wide 8-inch minimum\*** white lane line marking shall be used to separate the tapered parallel deceleration lane from the optional exit lane.**



*Guidance:*

- 22 *On the approach to a multi-lane exit ramp having a lane drop condition and an optional exit lane that also carries through traffic, the wide 8-inch minimum\* white line should extend from 100 feet in advance of the theoretical gore to the physical gore (see Drawing B of Figure 3B-10(VA) in this Supplement). On the approach to a multi-lane exit ramp having an additional tapered parallel deceleration lane and an optional exit lane that also carries through traffic, the wide 8-inch minimum\* white line should extend from 100 feet in advance of the theoretical gore to the physical gore (see Drawing C of Figure 3B-8(VA) in this Supplement).*
- 23 *Lane drop markings used in advance of lane drops at intersections should begin a distance in advance of the intersection that is determined by engineering judgment as suitable to enable drivers who do not desire to make the mandatory turn to move out of the lane being dropped prior to reaching the queue of vehicles that are waiting to make the turn. The lane drop marking should begin no closer to the intersection than the most upstream regulatory or warning sign associated with the lane drop.*

**Support:**

- 24 **Section 3B.20 of this Supplement** contains information regarding other markings that are associated with lane drops, such as lane-use arrow markings and ONLY word markings.
- 25 **Section 3B.09 of the MUTCD this Supplement\*** contains information about the lane line markings that are to be used for transition areas where the number of through lanes is reduced.

**Standard:**

- 26 **Where crossing the lane line markings is discouraged, the lane line markings shall consist of a normal or wide solid white line.**

*Guidance:*

- 27 *At an intersection, a normal width solid white lane line should extend at least 100 feet upstream from the stop line.*

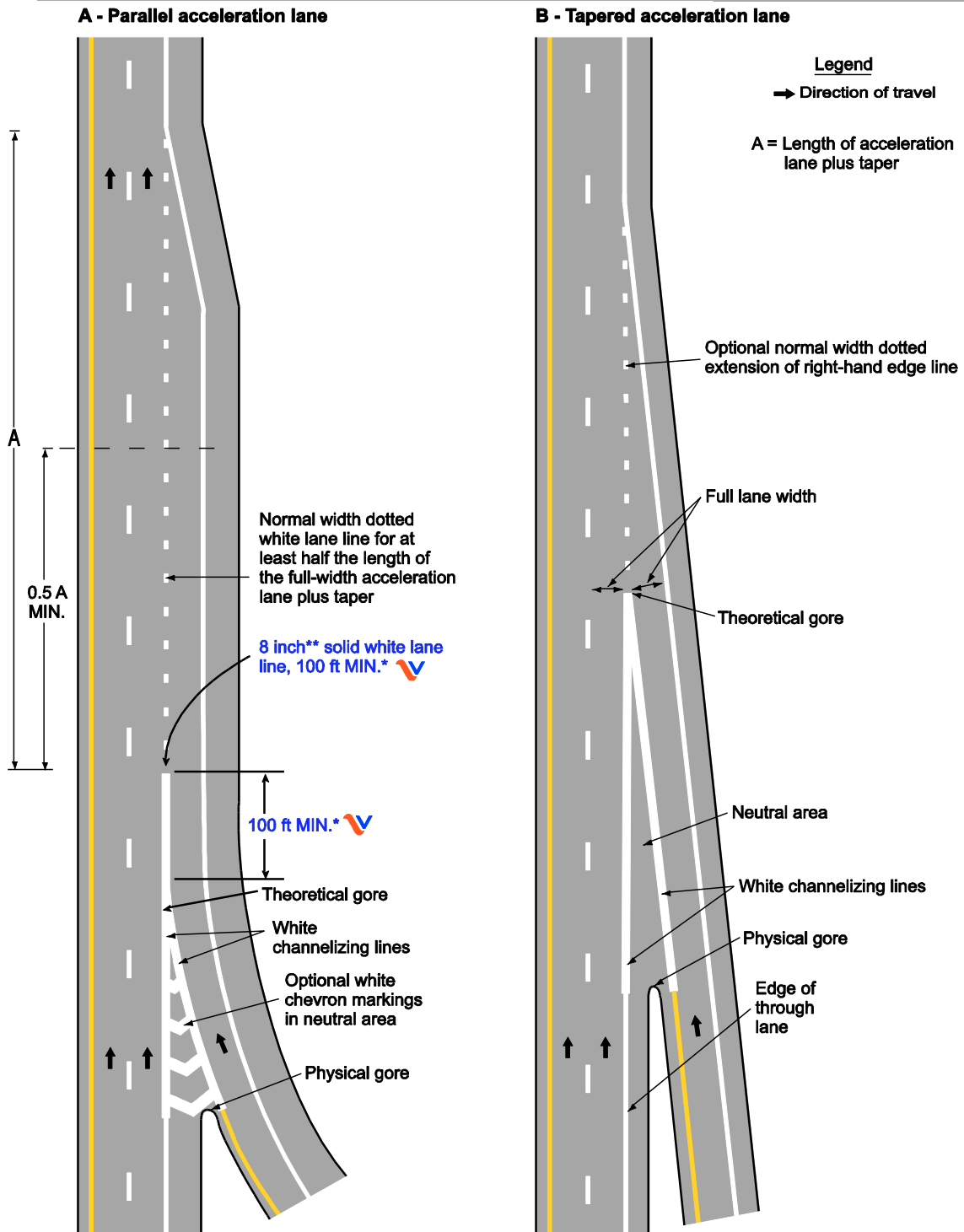
**Support:**

- 28 **Section 3B.09 of the MUTCD this Supplement\*** contains information about the lane line markings that are to be used for transition areas where the number of through lanes is reduced.



## Figure 3B-9(VA) Example of Dotted Line and Channelizing Line Applications for Entrance Ramp Markings

(This Figure has been updated for the Virginia Supplement to the MUTCD – Revision 1.)\*

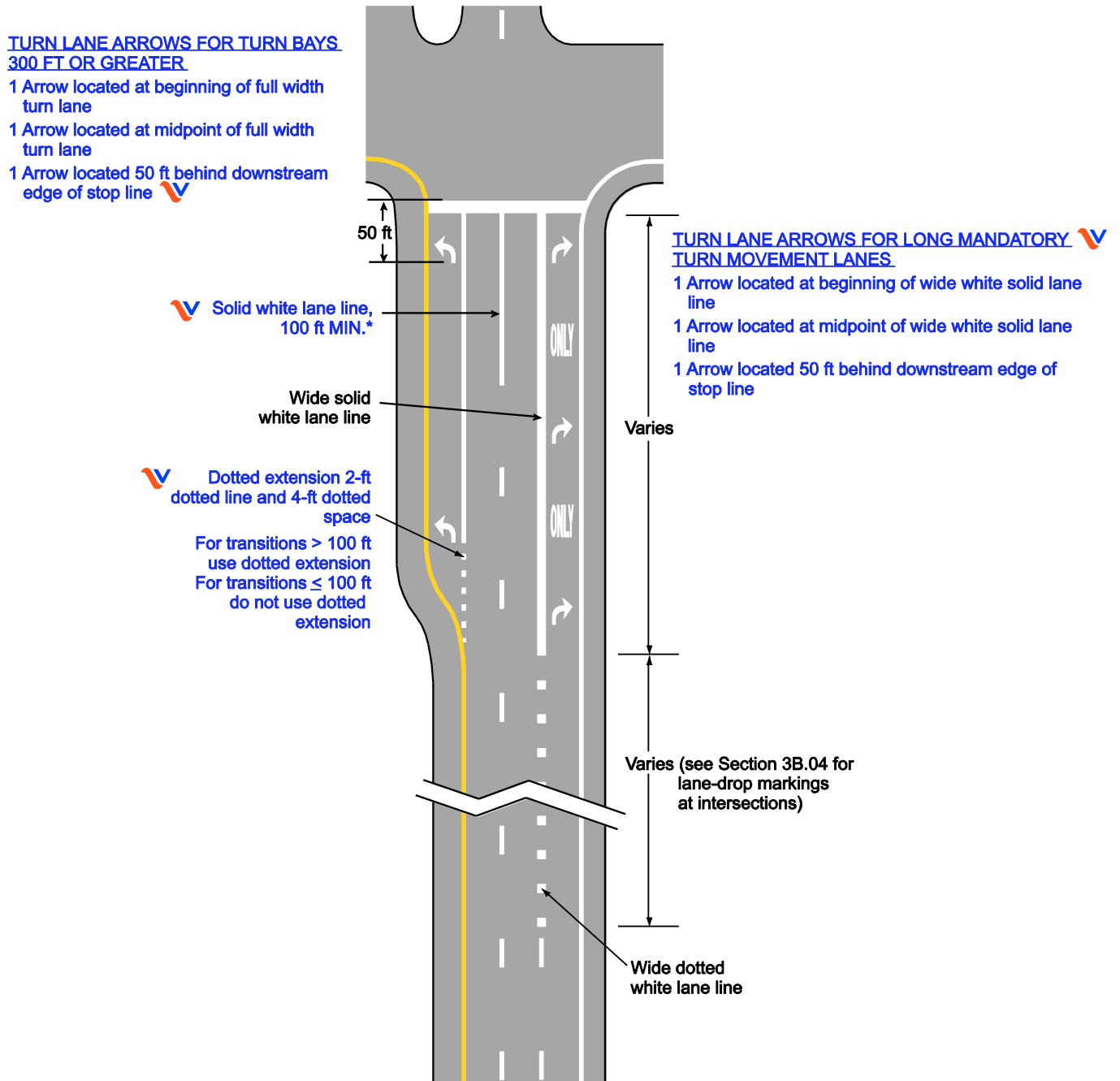


\*Minimums are recommended distances where spacing allows or is feasible

\*\*For all thicker emphasis lines in gore areas, the width shall be 8 inches minimum.

## Figure 3B-11(VA). Examples of Applications of Intersection Approach Markings (Sheet 1 of 2)

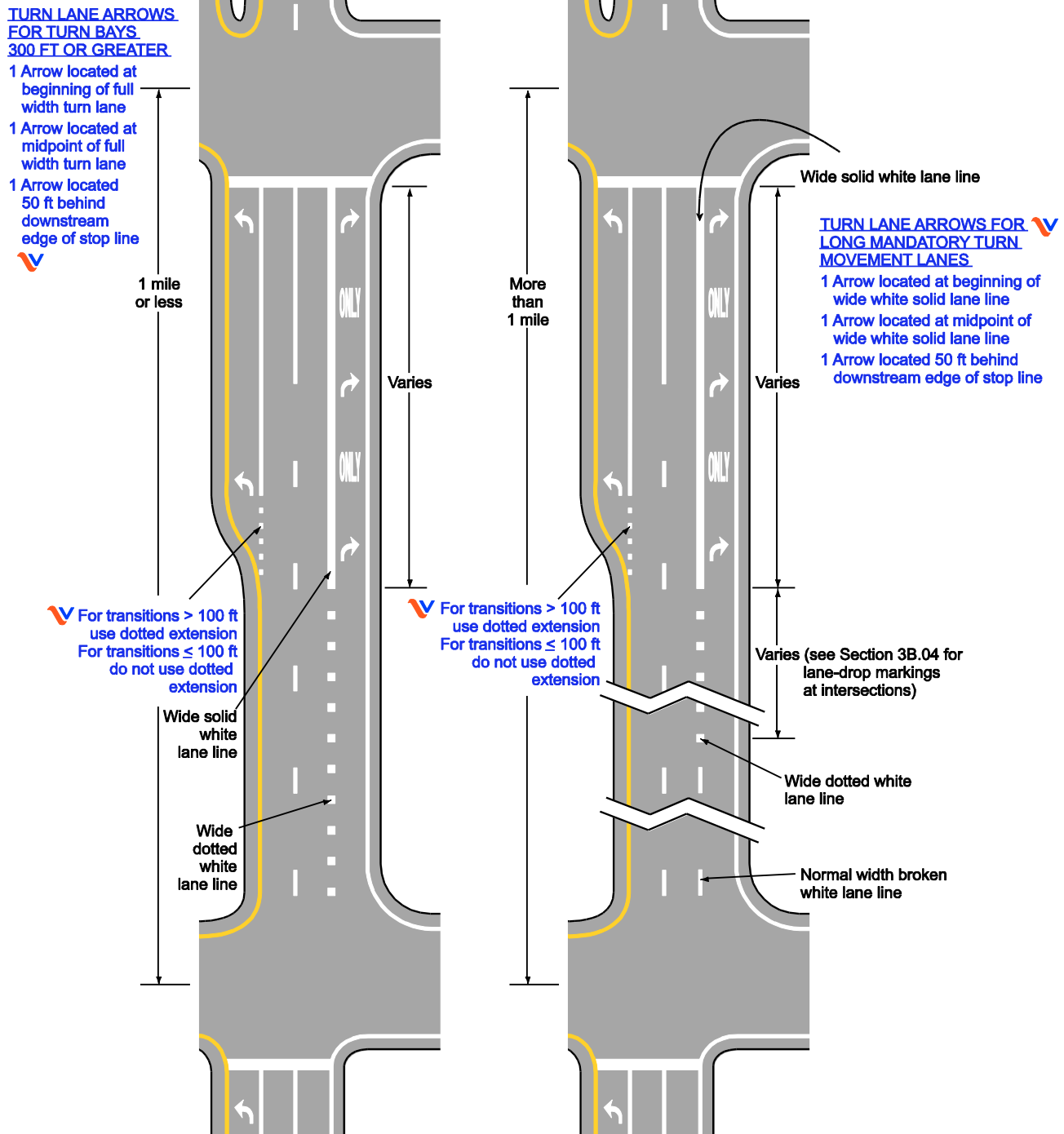
**A – Lane drop at an intersection**



\* Minimums are recommended distances where spacing allows or is feasible


### Figure 3B-11(VA). Examples of Applications of Intersection Approach Markings (Sheet 2 of 2)

#### B – Auxiliary lane between intersections





*Guidance:*

- 
- 29 *On approaches to intersections, a solid white lane line marking should be used to separate a through lane from an added mandatory turn lane.*
- 30 *On tapers approaching added mandatory turn lanes, dotted white lane line markings with a 2-foot line and 4-foot space should be used. If the added mandatory turn lane is less than or equal to 100 feet in length, dotted white lane line markings should not be used (see Figure 3B-11(VA) in this Supplement).*

*Option:*


- 31 Where the median width allows the left-turn lanes to be separated from the through lanes to give drivers on opposing approaches a less obstructed view of opposing through traffic, white pavement markings may be used to form channelizing islands as shown in Figure 2B-17 in the MUTCD.
- 32 Solid white lane line markings may be used to separate through traffic lanes from auxiliary lanes, such as an added uphill truck lane or a preferential lane (see Section 3D.02 of this Supplement).
- 33 Wide solid lane line markings may be used for greater emphasis.

**Standard:**

- 34 **Where crossing the lane line markings is prohibited, the lane line markings shall consist of a solid double white line (see Figure 3B-12).**

## **Section 3B.05 Other White Longitudinal Pavement Markings**

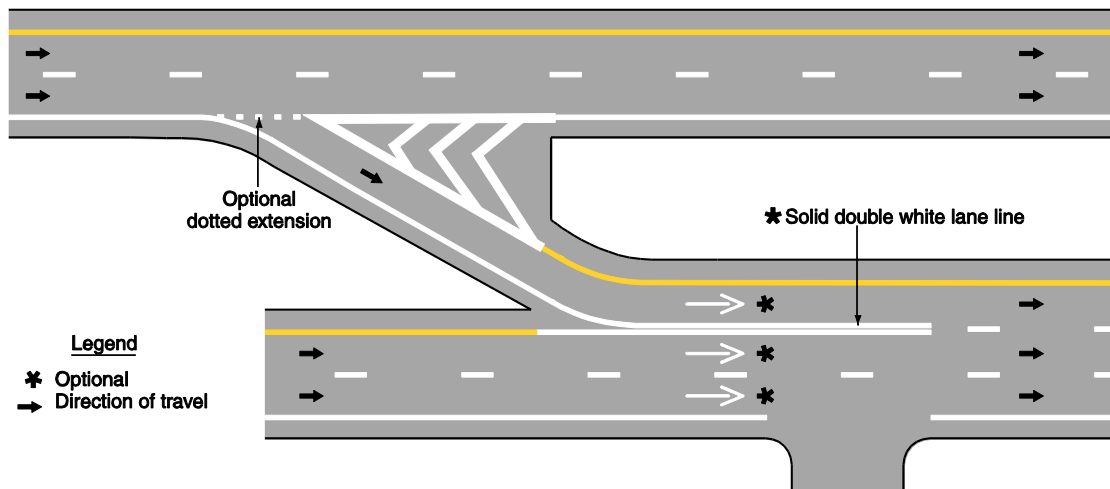
**Standard:**

- 
- 01 **A channelizing line shall be a wide or double solid white line.**
- 02 **Channelizing lines shall be used to form channelizing islands where traffic traveling in the same direction is permitted on both sides of the island.**
- 03 **Other pavement markings in the channelizing island area shall be white.**

*Support:*

- 04 Examples of channelizing line applications are shown in Figures 3B-8(VA), 3B-9(VA), and 3B-10(VA) in this Supplement, and in Drawing C of Figure 3B-15.
- 05 Channelizing lines at exit ramps as shown in Figures 3B-8(VA) and 3B-10(VA) in this Supplement define the neutral area, direct exiting traffic at the proper angle for smooth divergence from the main lanes into the ramp, and reduce the probability of colliding with objects adjacent to the roadway.

**Figure 3B-12. Example of Solid Double White Lines Used to Prohibit Lane Changing**



- 06 Channelizing lines at entrance ramps as shown in Figures 3B-9(VA) and 3B-10(VA) in this Supplement promote orderly and efficient merging with the through traffic.

**Standard:**

- 07 For all exit ramps and for entrance ramps with parallel acceleration lanes, channelizing lines shall be placed on both sides of the neutral area (see Figures 3B-8(VA) and 3B-10(VA) and Drawing A of Figure 3B-9(VA) in this Supplement).

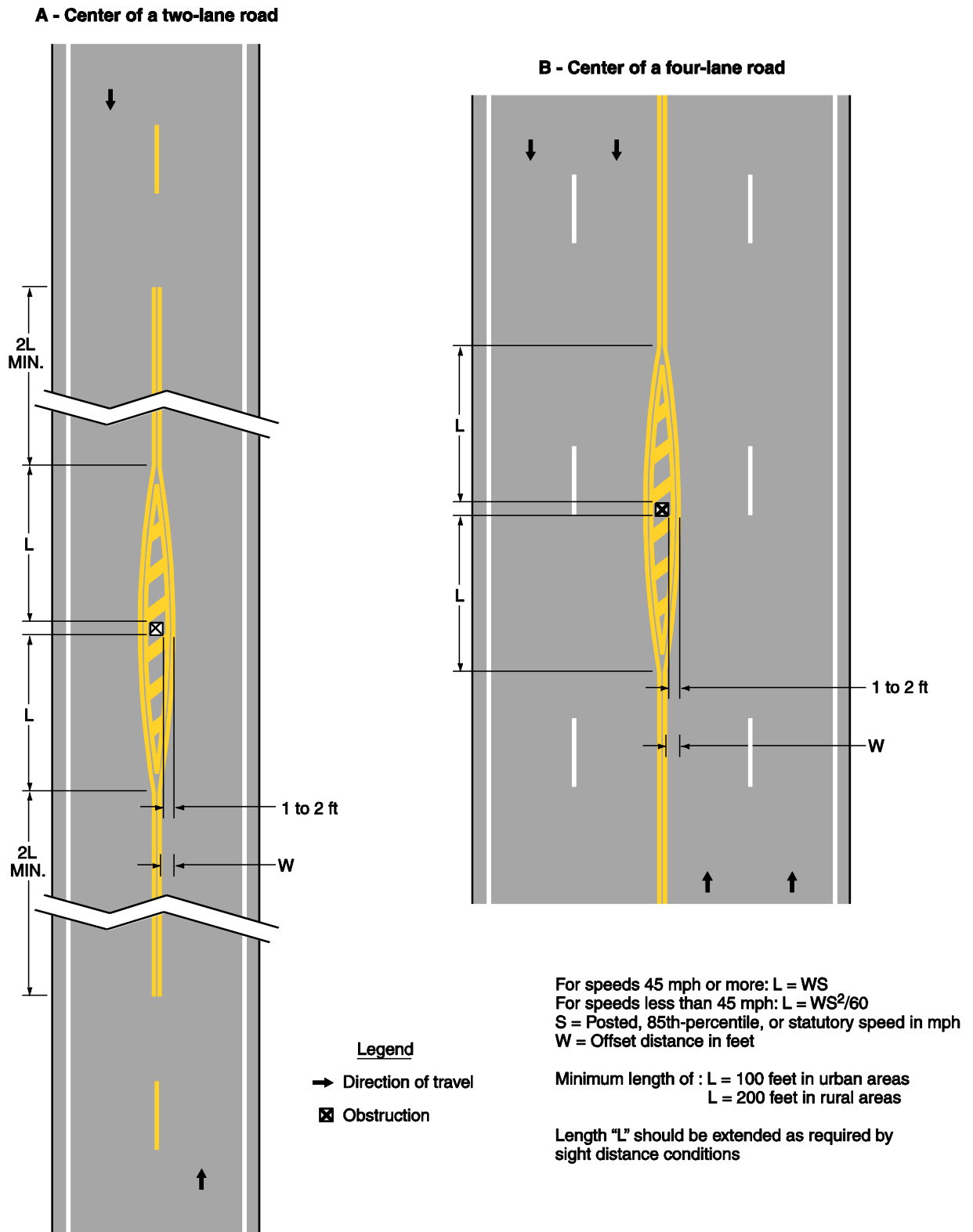


- ~~08 For entrance ramps with tapered acceleration lanes, channelizing lines shall be placed along both sides of the neutral area to a point at least one half of the distance to the theoretical gore (see Drawing C of Figure 3B-9(VA)).~~

**Standard:**

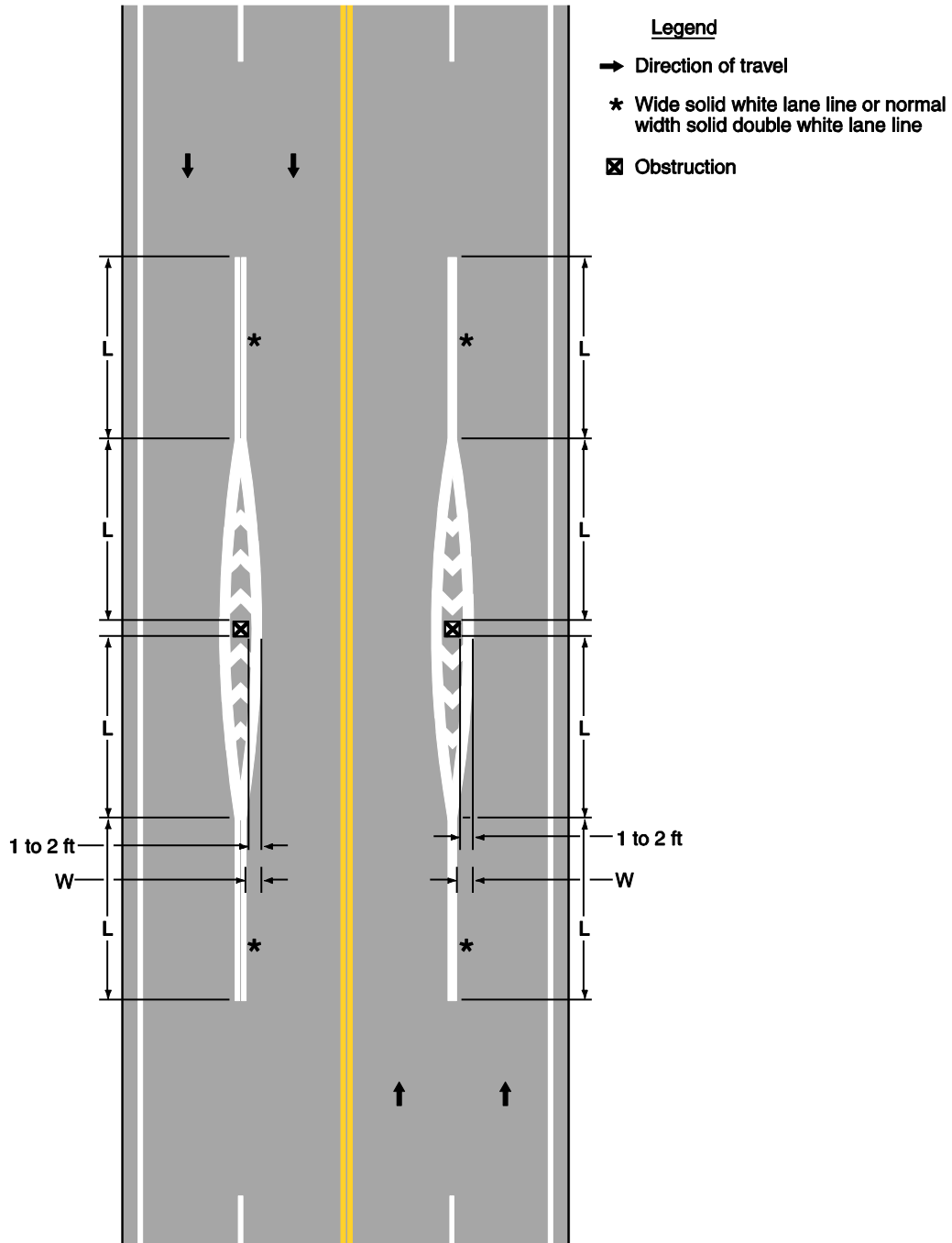
- 09 For entrance ramps with tapered acceleration lanes, the channelizing lines shall extend to the theoretical gore (see Drawing B of Figure 3B-9(VA) in this Supplement).

### Figure 3B-15. Examples of Applications of Markings for Obstructions in Roadway (Sheet 1 of 2)



## Figure 3B-15. Examples of Applications of Markings for Obstructions in Roadway (Sheet 2 of 2)

**C - Traffic passing in the same direction on both sides of an obstruction**



For speeds of 45 mph or more:  $L = WS$   
 For speeds of less than 45 mph:  $L = WS^2/60$   
 S = Posted, 85th-percentile, or statutory speed in mph  
 W = Offset distance in feet

Minimum length of: L = 100 feet in urban areas  
 L = 200 feet in rural areas

Length "L" should be extended as required by sight distance conditions

Option:

- 10 White chevron crosshatch markings (see [Section 3B.24 of this Supplement](#)) may be placed in the neutral area of exit ramp and entrance ramp gores for special emphasis as shown in [Figures 3B-8\(VA\) and 3B-10\(VA\)](#) and Drawing A of [Figure 3B-9\(VA\)](#) in this [Supplement](#). The channelizing lines and the optional chevron crosshatch markings at exit ramp and entrance ramp gores may be supplemented with white retroreflective or internally illuminated raised pavement markers (see [Sections 3B.11 and 3B.13 of this Supplement](#)) for enhanced nighttime visibility.

**Standard:**

- 11 **For gore areas, wide 8-inch minimum\* solid white lines shall be used for channelizing lines from the beginning of the theoretical gore to the beginning of the physical gore.**



## **Section 3B.06 Edge Line Pavement Markings**

**Standard:**

- 01 **If used, edge line pavement markings shall delineate the right or left edges of a roadway.**
- 02 **Except for dotted edge line extensions (see [Section 3B.08 of this Supplement](#)), edge line markings shall not be continued through intersections or major driveways.**
- 03 **If used on the roadways of divided highways or one-way streets, or on any ramp in the direction of travel, left edge line pavement markings shall consist of a normal solid yellow line to delineate the left-hand edge of a roadway or to indicate driving or passing restrictions left of these markings.**
- 04 **If used, right edge line pavement markings shall consist of a normal solid white line to delineate the right-hand edge of the roadway.**

*Guidance:*

- 05 *Edge line markings should not be broken for minor driveways.*

**Support:**

- 06 Edge line markings have unique value as visual references to guide road users during adverse weather and visibility conditions.

Option:

- 07 Wide solid edge line markings may be used for greater emphasis.

**Standard:**

- 08 **Where a paved shoulder is provided, the edge line, if used, shall be placed in the travel lane and not in the paved shoulder area.**



## Section 3B.07 Warrants for Use of Edge Lines

### Standard:



- ~~01 Edge line markings shall be placed on paved streets or highways with the following characteristics:~~
- ~~A. Freeways,~~
  - ~~B. Expressways, and~~
  - ~~C. Rural arterials with a traveled way of 20 feet or more in width and an ADT of 6,000 vehicles per day or greater.~~

### Guidance:

- 02 *Edge line markings should be placed on paved streets or highways with the following characteristics:*
- A. *Rural arterials and collectors with a traveled way of 20 feet or more in width and an ADT of 3,000 vehicles per day or greater.*
  - B. *At other paved streets and highways where an engineering study indicates a need for edge line markings.*
- 03 *Edge line markings should not be placed where an engineering study or engineering judgment indicates that providing them is likely to decrease safety.*

### Option:

- 04 Edge line markings may be placed on streets and highways with or without center line markings.
- 05 Edge line markings may be excluded, based on engineering judgment, for reasons such as if the traveled way edges are delineated by curbs, parking, or other markings.
- 06 If a bicycle lane is marked on the outside portion of the traveled way, the edge line that would mark the outside edge of the bicycle lane may be omitted.
- 07 Edge line markings may be used where edge delineation is desirable to minimize unnecessary driving on paved shoulders or on refuge areas that have lesser structural pavement strength than the adjacent roadway.

### Standard:



- 08 **Except as provided in Paragraph 9 10\* below, edge line markings shall be placed on roadways meeting any of the following criteria:**
- A. Two-lane paved highways without curb and gutter having a pavement width of 20 feet or greater and center line pavement markings;**
  - B. Sections of Primary routes subject to frequent fog or located on mountain crossings;**
  - C. At narrow structures on all Primary routes where the horizontal clearance between the structure and edge of the pavement is 3 feet or less;**
- 09 **On two-lane roadways without continuous edge lines, edge lines shall be installed on approach to single-lane structures. In each direction, edge lines shall be installed in**

**the transition section and 300 feet upstream of the transition section (see Figure 3B-V1 in this Supplement).**

*Guidance*

- 10 *Edge line markings should not be installed on subdivision streets, unless the street is primarily serving through traffic.*

**Support:**

- 11 Criteria for placement of edge line markings are shown in Table 3B-V2.\*



## Table 3B-V2. Criteria For Placement of Edge Line Markings\*

(This Table has been added to the Virginia Supplement to the MUTCD – Revision 1.)\*

Pavement Width	Traffic Volume	Roadway Type					
		Undivided Limited Access	Bi-directional multi-lane	Two-lane Paved Roads with Center Line & without Curb and Gutter	Other Rural Arterials and Collectors	Local Residential	All Other Paved Roadway Segments
≥ 20 feet	≥ 3,000 vpd	Required	Required	Required	Recommended	Not Recommended unless primarily serving through traffic	May be considered only where Engineering Study indicates a need
	< 3,000 vpd	Required	Required	Required	May be considered only where Engineering Study indicates a need		
< 20 feet	≥ 3,000 vpd	Required	Required	May be considered only where Engineering Study indicates a need	May be considered only where Engineering Study indicates a need		
	< 3,000 vpd	Required	Required	May be considered only where Engineering Study indicates a need	May be considered only where Engineering Study indicates a need		

Note: See Paragraphs 8 and 9 of Section 3B.07 in this Supplement for additional locations where edge lines are required.

### Section 3B.08 Extensions through Intersections or Interchanges

**Standard:**

- 01 **Except as provided in Paragraph 2, pavement markings extended into or continued through an intersection or interchange area shall be the same color and at least the same width as the line markings they extend (see Figure 3B-13(VA) in this Supplement).**

**Option:**

- 02 A normal line may be used to extend a wide line through an intersection.

**Standard:**

- 03 **Where highway design or reduced visibility conditions make it desirable to provide control or to guide vehicles through an intersection or interchange, such as at offset,**



**skewed, complex, or multi-legged intersections, on curved roadways, where multiple turn lanes are used, or where offset turn lanes might cause driver confusion, dotted line extension markings consisting of 2-foot line segments and 4-foot gaps shall be used to extend longitudinal line markings through an intersection or interchange area.**

Option:

- 04 Dotted edge line extensions may be placed through intersections or major driveways.

*Guidance:*

- 05 *Where greater restriction is required, solid lane lines or channelizing lines should be extended into or continued through intersections or major driveways.*

**Standard:**

- 06 **Solid lines shall not be used to extend edge lines into or through intersections or major driveways.**

*Guidance:*

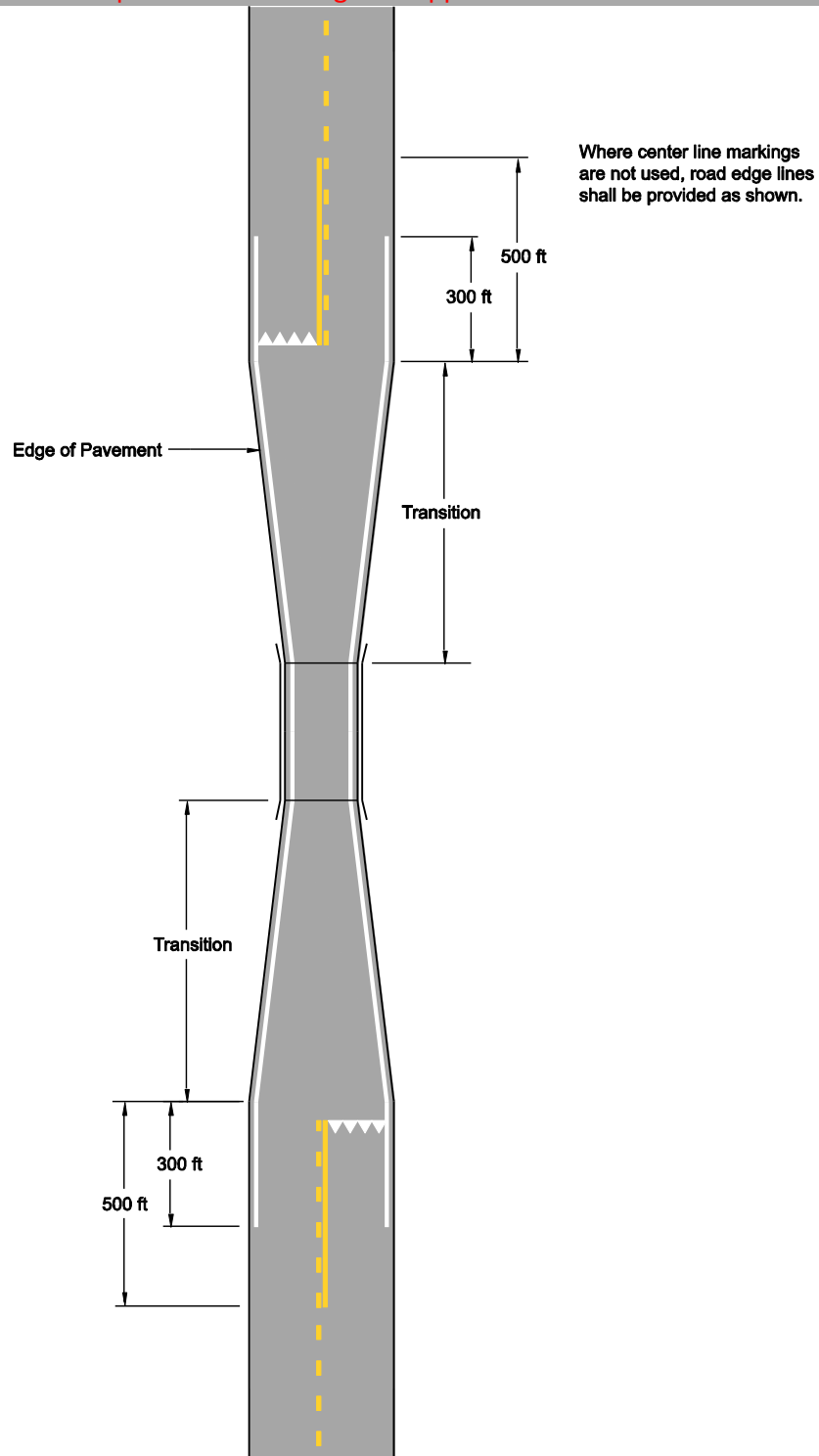
- 07 *Where a double line is extended through an intersection, a single line of equal width to one of the lines of the double line should be used.*
- 08 *To the extent possible, pavement marking extensions through intersections should be designed in a manner that minimizes potential confusion for drivers in adjacent or opposing lanes.*





## Figure 3B-V1. Typical Markings for Single Lane Structures on Two-Lane Roadways without Continuous Road Edge Lines

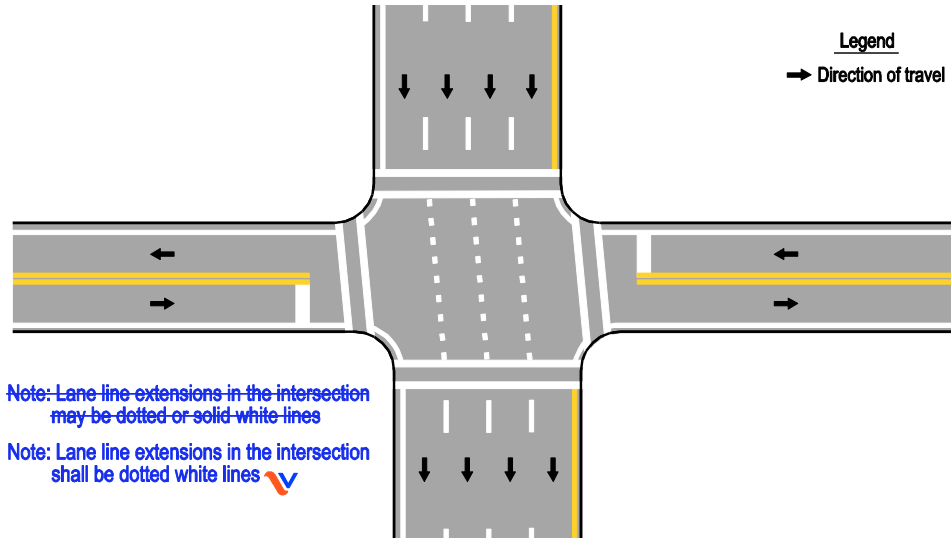
(This Figure has been updated for the Virginia Supplement to the MUTCD - Revision 1.)\*



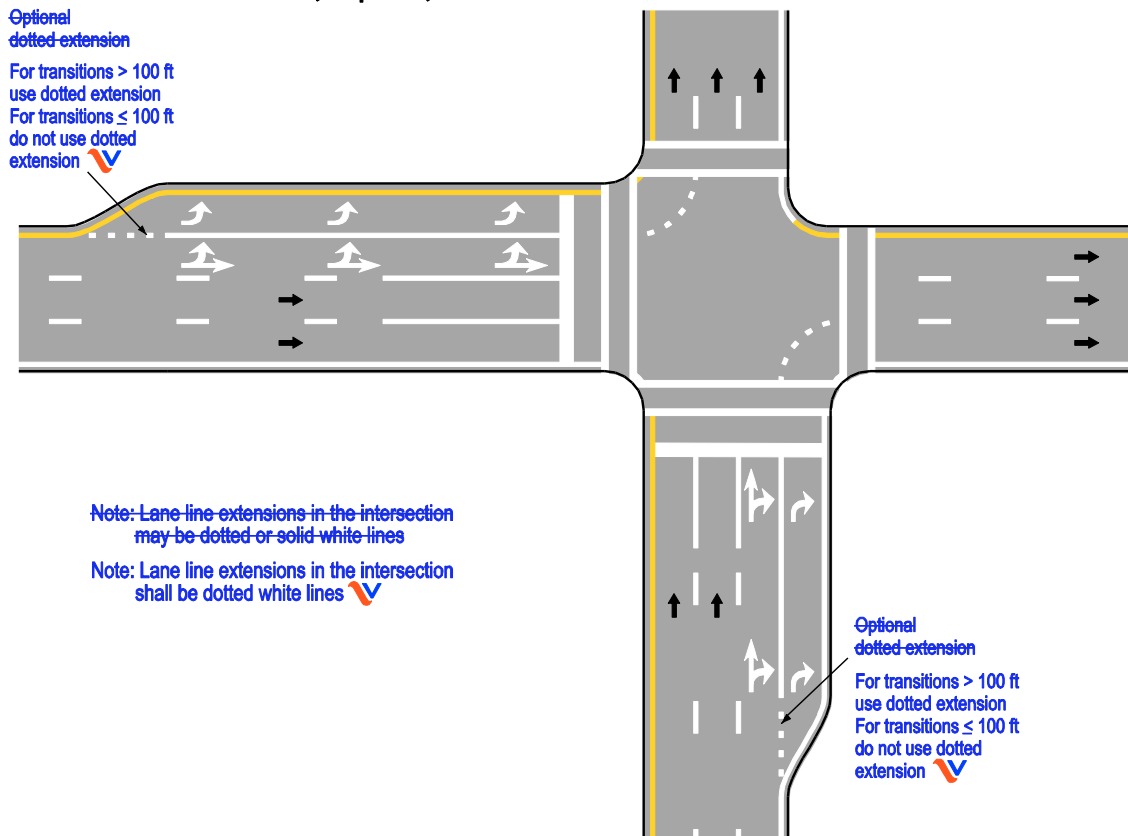
NOTE: See Figure 2C-V1 for typical sign placement for single lane structures on two-lane roadways.

## Figure 3B-13(VA). Examples of Line Extensions through Intersections (Sheet 1 of 2)

**A - Typical pavement markings with offset lane lines continued through the intersection and optional crosswalk lines and stop lines**

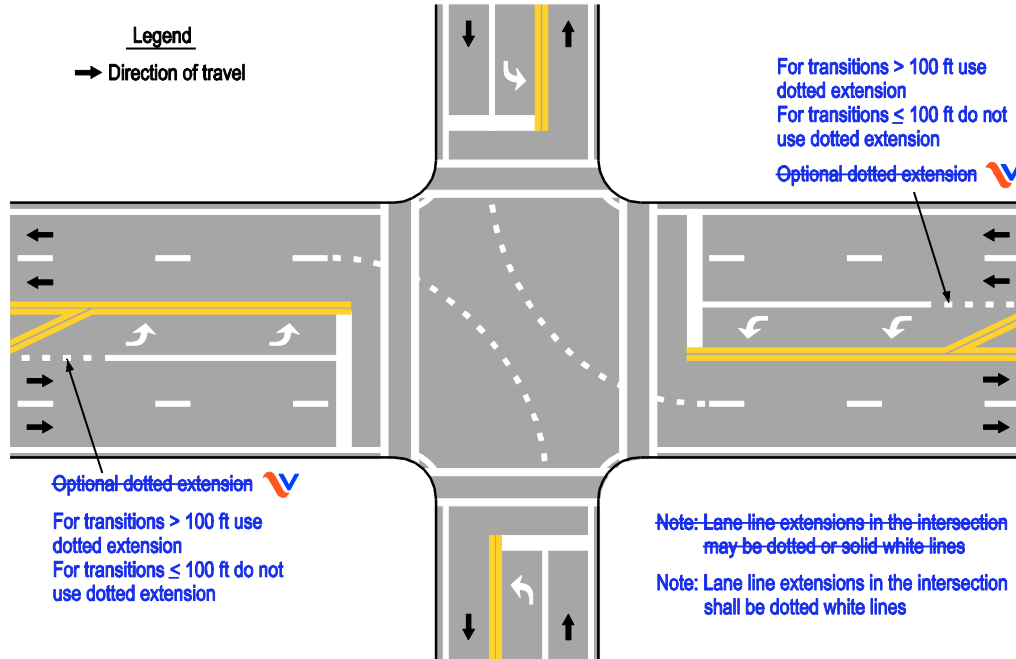


**B - Typical pavement markings with double-turn lanes, lane-use turn arrows, and optional crosswalk lines, stop lines, and line extensions into intersection for double turns**

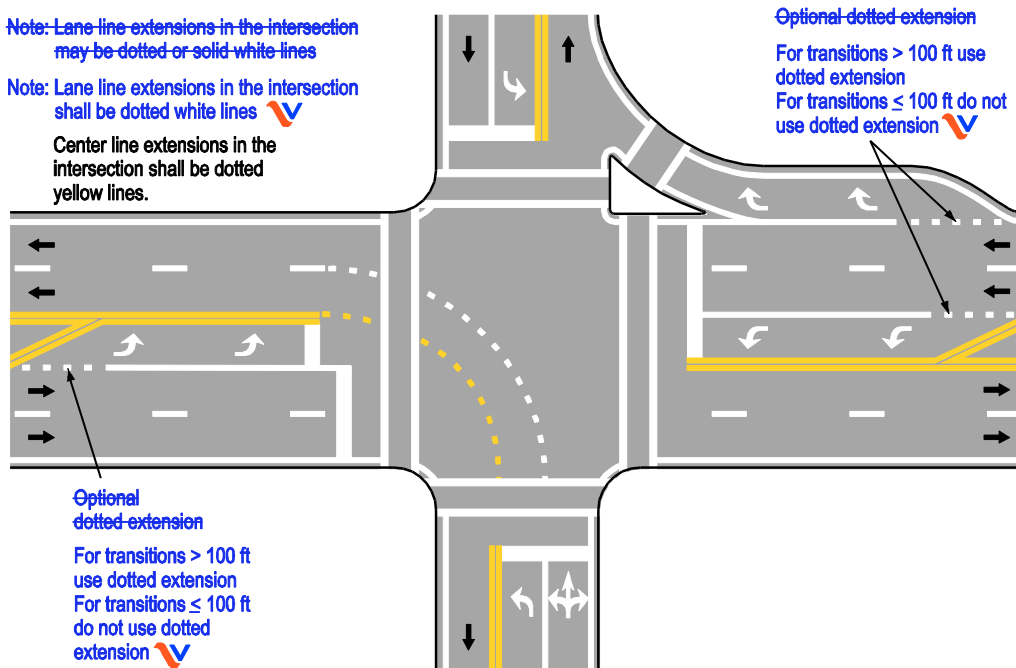


## Figure 3B-13(VA). Examples of Line Extensions through Intersections (Sheet 2 of 2)

### C - Typical dotted line markings to extend lane line markings into the intersection



### D - Typical dotted line markings to extend center line and lane line markings into the intersection



## Section 3B.09 Lane-Reduction Transition Markings

(This Section has been added to the Virginia Supplement to the MUTCD - Revision 1.)\*

### Support:

- 01 Lane-reduction transition markings are used where the number of through lanes is reduced because of narrowing of the roadway or because of a section of on-street parking in what would otherwise be a through lane. Lane-reduction transition markings are not used for lane drops.\*

### Standard:

- 02 Except as provided in Paragraph 3, where pavement markings are used, lane-reduction transition markings shall be used to guide traffic through transition areas where the number of through lanes is reduced, as shown in Figure 3B-14. On two-way roadways, no-passing zone markings shall be used to prohibit passing in the direction of the convergence, and shall continue through the transition area.\*

### Option:

- 03 On low-speed urban roadways where curbs clearly define the roadway edge in the lane-reduction transition, or where a through lane becomes a parking lane, the edge line and/or delineators shown in Figure 3B-14 may be omitted as determined by engineering judgment.\*

### Guidance:

- 04 For roadways having a posted or statutory speed limit of 45 mph or greater, the transition taper length for a lane-reduction transition should be computed by the formula  $L = WS$ . For roadways where the posted or statutory speed limit is less than 45 mph, the formula  $L = WS^2/60$  should be used to compute the taper length.\*

### Support:

- 05 Under both formulas, L equals the taper length in feet, W equals the width of the offset distance in feet, and S equals the 85th-percentile speed or the posted or statutory speed limit, whichever is higher.\*

### Guidance:

- 06 Where observed speeds exceed posted or statutory speed limits, longer tapers should be used.\*

### Option:

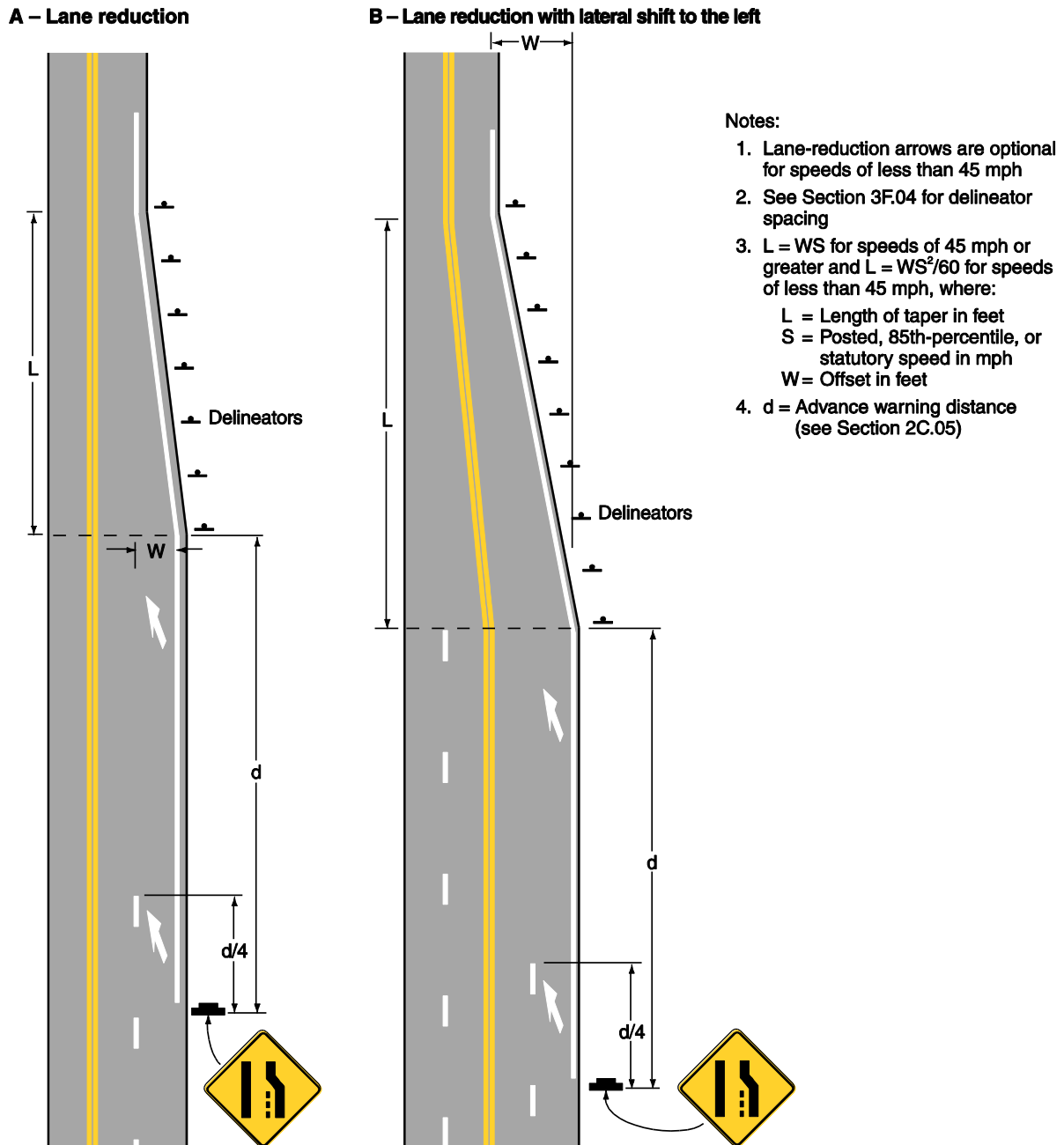
- 07 On new construction, where no posted or statutory speed limit has been established, the design speed may be used in the transition taper length formula.\*

### Guidance:

- 08 Lane line markings should be discontinued one-quarter of the distance between the Lane Ends sign (see Section 2C.42 in the MUTCD) and the point where the transition taper begins.\*

09 Except as provided in Paragraph 3 for low-speed urban roadways, the edge line markings shown in Figure 3B-14 should be installed from the location of the Lane Ends warning sign to beyond the beginning of the narrower roadway.\*

## Figure 3B-14. Examples of Applications of Lane-Reduction Transition Markings\*



Support:  
 10 Pavement markings at lane-reduction transitions supplement the standard signs.\*

**Standard:**

- 11 **Where a lane-reduction transition occurs on a roadway with a speed limit of 45 mph or greater, the lane-reduction arrow markings shall be used (see Figure 3B-14 and Drawing F in Figure 3B-24(VA)).\***

**Guidance:**

- 12 *Except for acceleration lanes, where a lane-reduction transition occurs on a roadway with a speed limit of less than 45 mph, the lane-reduction arrow markings shown in Drawing F in Figure 3B-24(VA) in this Supplement should be used if determined to be appropriate based on engineering judgment.\**

## **Section 3B.11 Raised Pavement Markers – General**

**Standard:**

- 01 **Permanent raised pavement markers used for the purpose of delineation shall be snowplowable, unless otherwise approved to address unique or temporary situations. For use of temporary markers see the “Virginia Work Area Protection Manual.”**
- 02 **The color of raised pavement markers under both daylight and nighttime conditions shall conform to the color of the marking for which they serve as a positioning guide, or for which they supplement or substitute.**

**Option:**

- 03 The side of a raised pavement marker that is visible to traffic proceeding in the wrong direction may be red (see [Section 3A.05 of this Supplement](#)).
- 04 Retroreflective or internally illuminated raised pavement markers may be used in the roadway immediately adjacent to curbed approach ends of raised medians and curbs of islands, or on top of such curbs (see [Section 3B.23 of the MUTCD](#)).

**Support:**

- 05 Retroreflective and internally illuminated raised pavement markers are available in mono-directional and bidirectional configurations. The bidirectional marker is capable of displaying the applicable color for each direction of travel.
- 06 Blue raised pavement markers are sometimes used in the roadway to help emergency personnel locate fire hydrants.

**Standard:**

- 07 **When used, internally illuminated raised pavement markers shall be steadily illuminated and shall not be flashed.**

**Support:**

- 08 Flashing raised pavement markers are considered to be In-Roadway Lights (see Chapter 4N).

**Guidance:**

- 09 *Non-retroreflective raised pavement markers should not be used alone, without supplemental retroreflective or internally illuminated markers, as a substitute for other types of pavement markings.*

- 10 *Directional configurations should be used to maximize correct information and to minimize confusing information provided to the road user. Directional configurations also should be used to avoid confusion resulting from visibility of markers that do not apply to the road user.*
- 11 *The spacing of raised pavement markers used to supplement or substitute for other types of longitudinal markings should correspond with the pattern of broken lines for which the markers supplement or substitute.*

**Standard:**

- 12 **The value of N cited in Sections 3B.12 through 3B.14 of this Supplement for the spacing of raised pavement markers shall equal the length of one line segment plus one gap of the broken lines used on the highway.**

**Option:**

- 13 For additional emphasis, retroreflective raised pavement markers may be spaced closer than described in Sections 3B.12 through 3B.14 of this Supplement, as determined by engineering judgment or engineering study.

**Support:**

- 14 Figures 9-20 through 9-22 in the "Traffic Control Devices Handbook" (see Section 1A.11 in this Supplement) contain additional information regarding the spacing of raised pavement markers on longitudinal markings.

**Standard:**

- 15 **Raised pavement markers shall be installed on roadways meeting the conditions shown in Table 3B-V1 V3\* in this Supplement.**

**Guidance:**

- 16 *Raised pavement markers should be considered for installation on roadways meeting the conditions shown in Table 3B-V2 V4\* in this Supplement.*

**Option:**

- 17 Raised pavement markers may be considered for installation on roadways meeting the conditions shown in Table 3B-V3 V5\* in this Supplement.

**Support:**

- 18 Figure 3B-V2 in this Supplement provides typical spacing layouts of raised pavement markers.

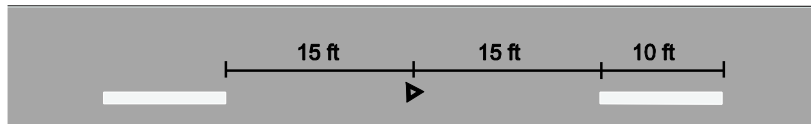




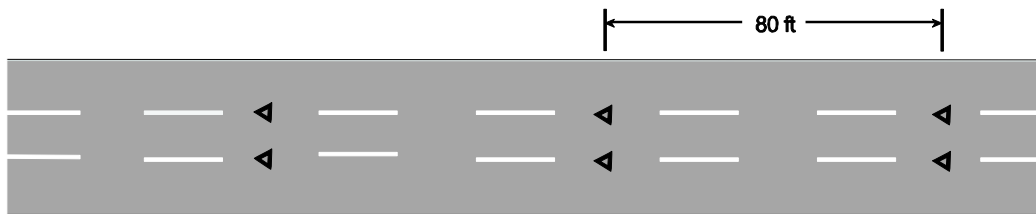
## Figure 3B-V2. Typical Raised Pavement Marker Layout Details (Sheet 1 of 2)

(This Figure has been updated for the Virginia Supplement to the MUTCD - Revision 1.)\*

### A - Raised Pavement Markers supplementing broken lines



### B - Divided roadways

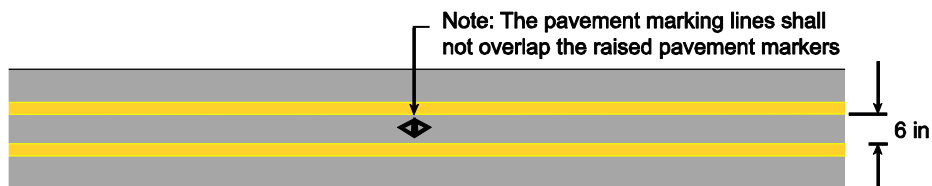


Note: Raised Pavement Marker spacing may be reduced along curves or in other locations based on engineering judgement.

### C - Raised Pavement Markers adjacent to solid line



### D - Raised Pavement Markers between double solid lines



#### Key

- ◀ Two-way, with points facing each direction of traffic
- ▶ One-way, with point facing traffic

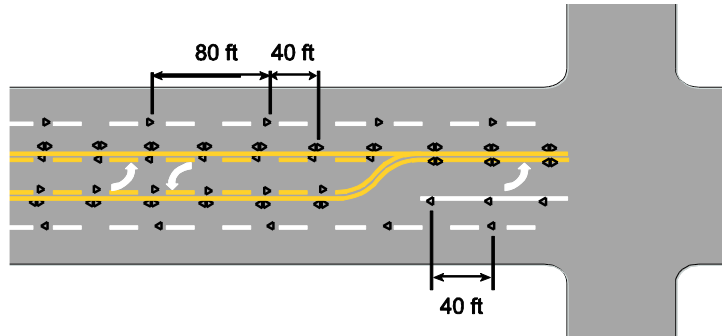




## Figure 3B-V2. Typical Raised Pavement Marker Layout Details (Sheet 2 of 2)

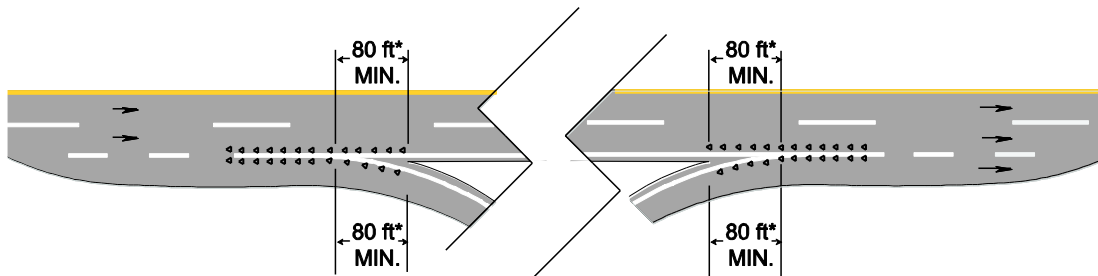
(This Figure has been updated for the Virginia Supplement to the MUTCD - Revision 1.)\*

**E - Two-way left turn lane and center lane left turn**



Note: Raised Pavement Marker spacing may be modified based on engineering judgement.

**F - Exit and entrance ramps**



**Key**

- ◈ Two-way, with points facing each direction of traffic
- ◄ One-way, with point facing traffic

\* Raised Pavement Markers may be extended along the entire channelizing line if needed for additional delineation, visibility, or emphasis.



**Table 3B-V1 V3\* . Conditions where Snowplowable Raised Pavement Markers (SRPMs) Shall be Installed**

Facility Type / Conditions	Required Placement
Limited Access Highways $\geq$ 2 miles in length AND Posted Speed Limit $\geq$ 55 MPH	SRPMs shall be installed continuously and to supplement solid lines at exit and entrance ramps at gore areas.
Limited Access Highways < 2 miles in length AND With posted Speed Limit $\geq$ 55 MPH AND Where adjacent approaching or departing non-limited access sections are marked with SRPMs	SRPMs shall be installed continuously and to supplement solid lines at exit and entrance ramps at gore areas.
Roadway Facilities with Posted Speed Limit $\geq$ 60 MPH	SRPMs shall be installed continuously.
Two-Lane, Two-Way Roadways with: AADT $\geq$ 15,000 AND No roadway lighting	SRPMs shall be installed continuously.
Multilane Roadways with: AADT $\geq$ 25,000 AND Posted Speed Limit $\geq$ 45 MPH AND No roadway lighting	SRPMs shall be installed continuously.



**Table 3B-V2 V4\* . Conditions where Snowplowable Raised Pavement Markers (SRPMs) Should be Considered**

Facility Type/Conditions	Recommended Placement	Additional Considerations
Multilane Roadways with: 15,000 $\leq$ AADT < 25,000 AND Posted Speed Limit 45-55 mph	SRPMs should be installed continuously.	If roadway lighting is present, engineering judgment should be used to determine if SRPMs will add benefit to the motorists.



**Table 3B-V3 V5\*. Conditions where Snowplowable Raised Pavement Markers (SRPMs) May be Considered**

Facility Type/Conditions	Placement	Additional Considerations
<b>Two-Lane, Two-Way Roadways with:</b> <b>5,000 ≤ AADT &lt; 15,000</b> <b>AND</b> <b>Only if the sections DO NOT have multiple horizontal curves with Posted Speed Limit &lt; 55 MPH</b>	SRPMs may be installed continuously.	Engineering judgment should be applied to determine whether SRPMs will add benefit to the motorists. Engineering judgment should take into consideration the presence of roadway lighting.
<b>Two-Lane, Two-Way Roadways with:</b> <b>AA DT ≥ 15,000</b> <b>AND</b> <b>Roadway lighting present</b>	SRPMs may be installed continuously.	Engineering judgment should be used to determine if SRPMs will add benefit to the motorists.
<b>Multilane Roadways with:</b> <b>AA DT ≥ 25,000</b> <b>AND</b> <b>Posted Speed Limit 45-55 mph</b> <b>AND</b> <b>Roadway lighting present</b>	SRPMs may be installed continuously.	Engineering judgment should be used to determine if SRPMs will add benefit to the motorists.
<p>If engineering judgment indicates that additional delineation is needed in spot locations, SRPMs may be considered for installation. Potential problems that may justify this special consideration include but are not limited to: high crash locations demonstrating significant crash proportions due to roadway departures, complex intersection configurations, detours, fog-prone areas, and highway segments with wet and nighttime crash histories that could be alleviated with SRPMs.</p>		

## **Section 3B.12 Raised Pavement Markers as Vehicle Positioning Guides with Other Longitudinal Markings**

Option:

- 01 Retroreflective or internally illuminated raised pavement markers may be used as positioning guides with longitudinal line markings without necessarily conveying information to the road user about passing or lane-use restrictions. In such applications, markers may be positioned in line with or immediately adjacent to a single line marking, or positioned between the two lines of a double center line or double lane line marking (see Drawing D of Figure 3B-V2 in this Supplement).



*Guidance:*

- 02 ~~The spacing for such applications should be 2N, where N equals the length of one line segment plus one gap (see Section 3B.11).~~

**Standard:**

- 03 **For no-passing zones on ~~multi-lane~~ undivided roadways, the maximum spacing for such applications shall be 40 feet. For all other roadways, the maximum spacing for such applications shall be 80 feet.**

**Option:**

- 04 Where it is desired to alert the road user to changes in the travel path, such as on sharp curves or on transitions that reduce the number of lanes or that shift traffic laterally, the spacing may be reduced to 40 feet or less.



- 05 ~~On freeways and expressways, the spacing may be increased to 3N for relatively straight and level roadway segments where engineering judgment indicates that such spacing will provide adequate delineation under wet night conditions.~~

**Support:**

- 06 ~~VDOT's "Guidelines for Snowplowable Raised Pavement Markers (SRPM)" document contains curve parameters for considering a reduced spacing of raised pavement markers.\*~~

## **Section 3B.13 Raised Pavement Markers Supplementing Other Markings**



**Standard:**

- 01 **The use of retroreflective or internally illuminated raised pavement markers for supplementing longitudinal line markings shall comply with the following requirements for longitudinal maximum spacing:**
- A. **When supplementing solid line markings, raised pavement markers ~~at a spacing~~ spaced\* no greater than 40 feet shall be used.**
  - B. **When supplementing broken line markings (see Drawings A and B of Figure 3B-V2), ~~a spacing~~ raised pavement markers spaced\* no greater than 80 feet shall be used. However, when supplementing broken line markings identifying reversible lanes, ~~a spacing of~~ raised pavement markers spaced\* no greater than 40 feet\* shall be used.**
  - C. **When supplementing double line markings, raised pavement markers spaced no greater than 80 feet shall be used.**
  - D. **When supplementing the markings used to define a one-way passing zone on a two-lane roadway, raised pavement markers supplementing the solid line shall be spaced no greater than 40 feet. Markers supplementing the broken lines shall be spaced no greater than 80 feet.**

*Guidance:*

- 02 *The use of retroreflective or internally illuminated raised pavement markers for supplementing longitudinal line markings should comply with the following:*
- A. *Lateral Positioning*
    - 1. *When supplementing double line markings, pairs of raised pavement markers placed laterally in line with or immediately outside of the two lines should be used.*
    - 2. *When supplementing wide line markings, pairs of raised pavement markers placed laterally adjacent to each other should be used.*
  - B. *Longitudinal Spacing*
    - 1. *When supplementing dotted lane line markings, spacing appropriate for the application should be used.*
    - 2. *When supplementing longitudinal line extension markings through at-grade intersections, one raised pavement marker for each short line segment should be used.*
    - 3. *When supplementing the markings used to define a two-way left turn lane, raised pavement markers should be installed with a spacing of 40 feet, as shown in Drawing E of Figure 3B-V2 in this Supplement.*
  - C. *Lateral Spacing*
    - 1. *When supplementing solid line markings, the lateral spacing between the edge of the raised pavement marker and solid line marking should be 3 inches, as shown in Drawing C of Figure 3B-V2 in this Supplement.*
- 03 *Raised pavement markers should not supplement right-hand edge lines unless an engineering study or engineering judgment indicates the benefits of enhanced delineation of a curve or other location would outweigh possible impacts on bicycles using the shoulder, and the spacing of raised pavement markers on the right-hand edge is close enough to avoid misinterpretation as a broken line during wet night conditions.*

**Standard:**

- 04 **When supplementing channelizing lines or edge line markings, a spacing of 20 feet shall be used for raised pavement markers. Placement of markers shall extend a minimum of 80 feet beyond the physical gore (see Drawing F of Figure 3B-V2 in this Supplement).**

**Option:**

- 05 **Raised pavement markers may be utilized along the entire channelizing line at exit ramps or entrance ramps if needed for additional delineation, visibility, or emphasis (see Drawing F of Figure 3B-V2 in this Supplement).\***
- 0506 **Raised pavement markers also may be used to supplement other markings such as channelizing islands, gore areas, approaches to obstructions, or wrong-way arrows.**
- 0607 **To improve the visibility of horizontal curves, center lines may be supplemented with retroreflective or internally illuminated raised pavement markers for the entire curved section as well as for a distance in advance of the curve that approximates 5 seconds of**



travel time. The spacing between markers in these applications may be reduced as determined by engineering judgment.

## **Section 3B.14 Raised Pavement Markers Substituting for Pavement Markings**

### **Standard:**



- 01 **Raised pavement markers shall not be used to substitute for pavement markings.**

## **Section 3B.16 Stop and Yield Lines**

### *Guidance:*

- 01 *Stop lines should be used to indicate the point behind which vehicles are required to stop in compliance with a traffic control signal.*

### *Option:*

- 02 Stop lines may be used to indicate the point behind which vehicles are required to stop in compliance with a STOP (R1-1) sign, ~~a Stop Here For Pedestrians (R1-5b or R1-5c) sign~~, or some other traffic control device that requires vehicles to stop, except YIELD signs that are not associated with passive grade crossings.

### *Support:*



- 03 The Code of Virginia § 46.2-924 requires that drivers at crosswalks yield the right-of-way to pedestrians crossing the roadway. The Standard statement in Section 2B.11 of the National MUTCD permits the use of the Stop Here for Pedestrians (R1-5b and R1-5c) signs only if state law specifically requires the driver to stop for a pedestrian in a crosswalk. As The Code of Virginia does not require a driver to stop, the R1-5b and R1-5c signs are not used in Virginia.

### *Option:*

- 04 Yield lines may be used to indicate the point behind which vehicles are required to yield in compliance with a YIELD (R1-2) sign or a Yield Here To Pedestrians (R1-5 or R1-5a) sign.

### **Standard:**



- 05 **Except as provided in Section 8B.28 of the MUTCD, stop lines shall not be used at locations where drivers are required to yield in compliance with a YIELD (R1-2) sign or a Yield Here To Pedestrians (R1-5 or R1-5a) sign or at locations on uncontrolled approaches where drivers are required by State law to yield to pedestrians.**
- 06 **Yield lines shall not be used at locations where drivers are required to stop in compliance with a STOP (R1-1) sign, ~~a Stop Here For Pedestrians (R1-5b or R1-5c) sign~~, a traffic control signal, or some other traffic control device.**
- 07 **Stop lines shall consist of solid white lines extending across approach lanes to indicate the point at which the stop is intended or required to be made.**

- 08 **Yield lines (see Figure 3B-16) shall consist of a row of solid white isosceles triangles pointing toward approaching vehicles extending across approach lanes to indicate the point at which the yield is intended or required to be made.**



- 09 **Stop lines shall be 24 inches wide.**

*Guidance:*

- 10 *The individual triangles comprising the yield line should have a base of 12 to 24 inches wide and a height equal to 1.5 times the base. The space between the triangles should be 3 to 12 inches.*

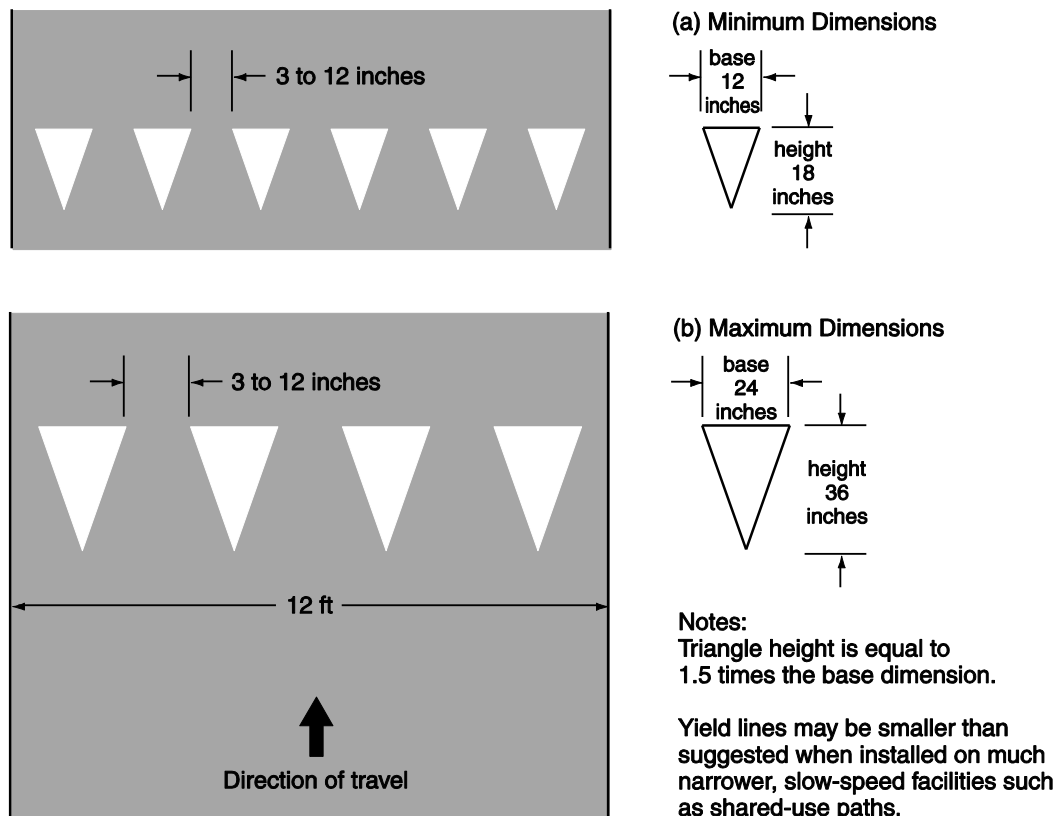


**Standard:**

- 11 **If used, stop and yield lines shall be placed a minimum of 4 feet in advance of the nearest crosswalk line at controlled intersections, except for yield lines at roundabouts as provided for in Section 3C.04 of the MUTCD and at midblock crosswalks. In the absence of a marked crosswalk, the stop line or yield line shall be placed at the desired stopping or yielding point, but shall not be placed more than 30 feet or less than 8 feet from the nearest edge of the intersecting traveled way.**

*Guidance:*

- 12 *Stop lines at midblock signalized locations should be placed at least 40 feet in advance of the nearest signal indication (see Section 4D.14 of the MUTCD).*
- 13 *If yield or stop lines are used at a crosswalk that crosses an uncontrolled multi-lane approach, the yield lines or stop lines should be placed 20 to 50 feet in advance of the nearest crosswalk line, and parking should be prohibited in the area between the yield or stop line and the crosswalk (see Figure 3B-17(VA) in this Supplement).*

**Figure 3B-16. Recommended Yield Line Layouts****Standard:**

- 14 If yield (~~stop~~) lines are used at a crosswalk that crosses an uncontrolled multi-lane approach, Yield Here To (~~Stop Here For~~) Pedestrians (R1-5 series) signs (see Section 2B.11 of this Supplement) shall be used.

*Guidance:*

- 15 Yield (~~stop~~) lines and Yield Here To (~~Stop Here For~~) Pedestrians signs should not be used in advance of crosswalks that cross an approach to or departure from a roundabout.

**Support:**

- 16 When drivers yield or stop too close to crosswalks that cross uncontrolled multi-lane approaches, they place pedestrians at risk by blocking other drivers' views of pedestrians and by blocking pedestrians' views of vehicles approaching in the other lanes.

**Option:**

- 17 Stop and yield lines may be staggered longitudinally on a lane-by-lane basis (see Drawing D of Figure 3B-13(VA) in this Supplement).





**Support:**

- 18 Staggered stop lines and staggered yield lines can improve the driver's view of pedestrians, provide better sight distance for turning vehicles, and increase the turning radius for left-turning vehicles.
- 19 [Section 8B.28 of the MUTCD](#) contains information regarding the use of stop lines and yield lines at grade crossings.

## **Section 3B.18 Crosswalk Markings**

**Support:**

- 01 Crosswalk markings provide guidance for pedestrians who are crossing roadways by defining and delineating paths on approaches to and within signalized intersections, and on approaches to other intersections where traffic stops.
- 02 In conjunction with signs and other measures, crosswalk markings help to alert road users of a designated pedestrian crossing point across roadways at locations that are not controlled by traffic control signals or STOP or YIELD signs.
- 03 At non-intersection locations, crosswalk markings legally establish the crosswalk.

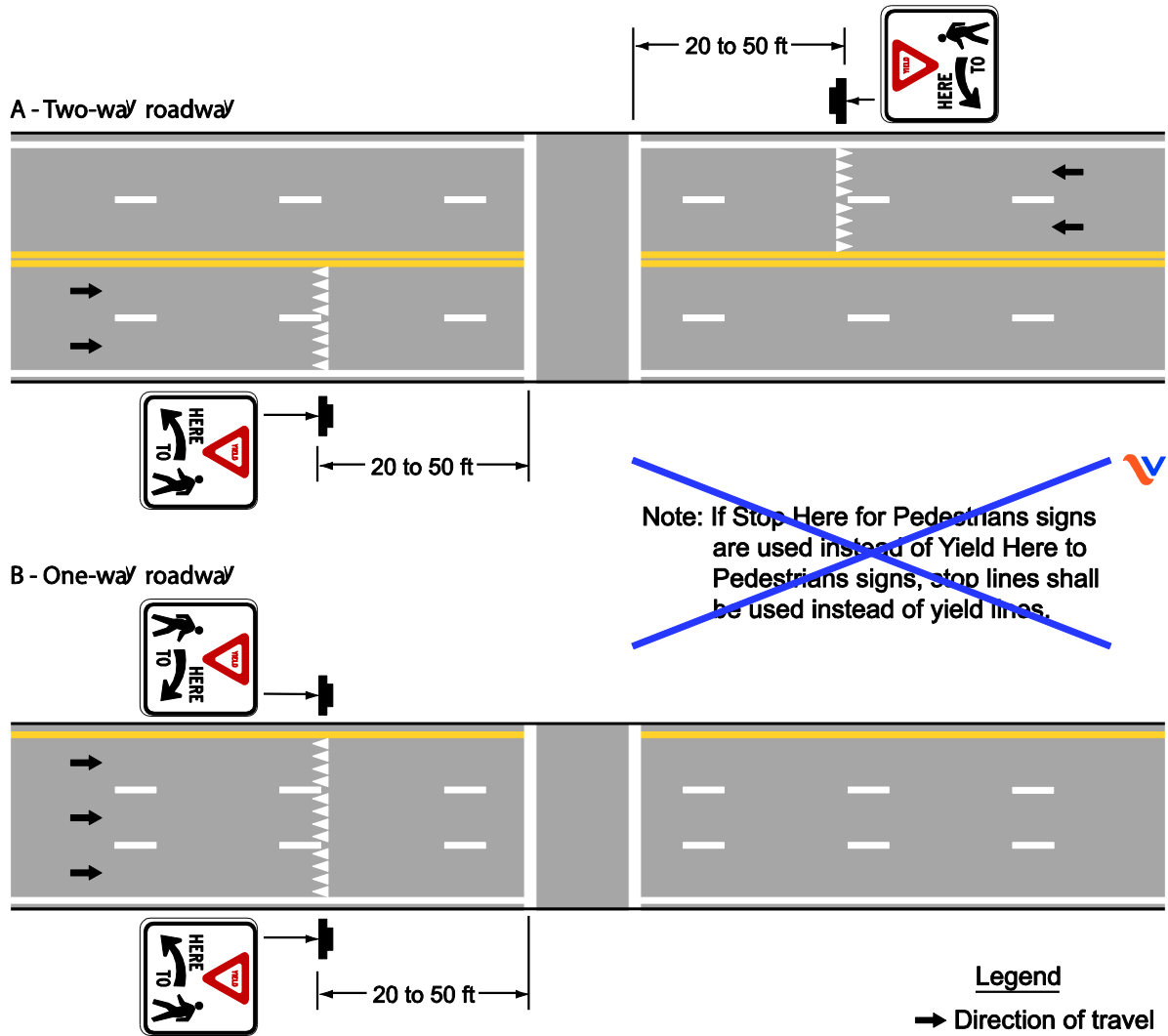
**Standard:**

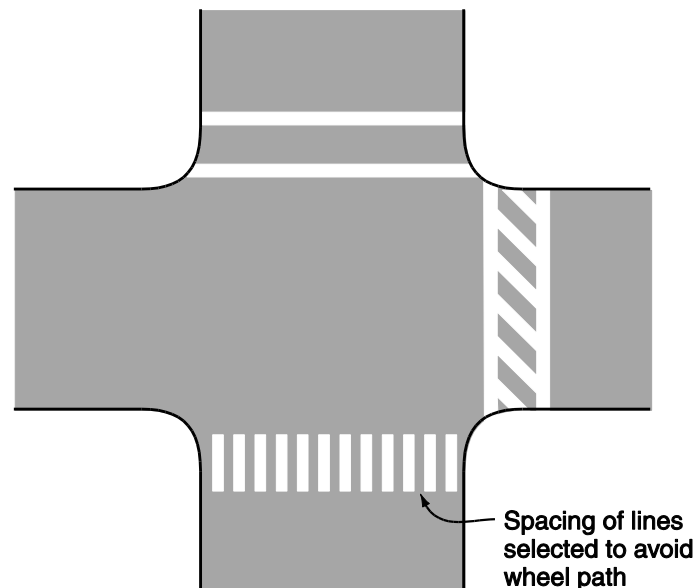
- 04 **When crosswalk lines are used, they shall consist of solid white lines that mark the crosswalk. They shall not be less than 6 inches or greater than 24 inches in width.**

*Guidance:*

- 05 *If transverse lines are used to mark a crosswalk, the gap between the lines should not be less than 6 feet. If diagonal or longitudinal lines are used without transverse lines to mark a crosswalk, the crosswalk should be not less than 6 feet wide.*
- 06 *Crosswalk lines, if used on both sides of the crosswalk, should extend across the full width of pavement or to the edge of the intersecting crosswalk to discourage diagonal walking between crosswalks (see [Figures 3B-17\(VA\) in this Supplement](#) and 3B-19).*
- 07 *At locations controlled by traffic control signals or on approaches controlled by STOP or YIELD signs, crosswalk lines should be installed where engineering judgment indicates they are needed to direct pedestrians to the proper crossing path(s).*

### Figure 3B-17(VA). Examples of Yield Lines at Unsignalized Midblock Crosswalks



**Figure 3B-19. Examples of Crosswalk Markings**

- 08 *Crosswalk lines should not be used indiscriminately. An engineering study should be performed before a marked crosswalk is installed at a location away from a traffic control signal or an approach controlled by a STOP or YIELD sign. The engineering study should consider the number of lanes, the presence of a median, the distance from adjacent signalized intersections, the pedestrian volumes and delays, the average daily traffic (ADT), the posted or statutory speed limit or 85th-percentile speed, the geometry of the location, the possible consolidation of multiple crossing points, the availability of street lighting, and other appropriate factors.*
- 09 *New marked crosswalks alone, without other measures designed to reduce traffic speeds, shorten crossing distances, enhance driver awareness of the crossing, and/or provide active warning of pedestrian presence, should not be installed across uncontrolled roadways where the speed limit exceeds 40 mph and either:*
- A. The roadway has four or more lanes of travel without a raised median or pedestrian refuge island and an ADT of 12,000 vehicles per day or greater; or*
  - B. The roadway has four or more lanes of travel with a raised median or pedestrian refuge island and an ADT of 15,000 vehicles per day or greater.*
- Support:
- 10 Chapter 4F contains information on Pedestrian Hybrid Beacons. [Section 4L.03 of the MUTCD](#) contains information regarding Warning Beacons to provide active warning of a pedestrian's presence. [Section 4N.02 of this Supplement](#) contains information regarding In-Roadway Warning Lights at crosswalks. Chapter 7D contains information regarding school crossing supervision.

*Guidance:*

- 11 *Because non-intersection pedestrian crossings are generally unexpected by the road user, warning signs (see [Section 2C.50 of this Supplement](#)) should be installed for all marked crosswalks at non-intersection locations and adequate visibility should be provided by parking prohibitions.*

## Support:

- 12 [Section 3B.16 of this Supplement](#) contains information regarding placement of stop line markings near crosswalk markings.

## Option:

- 13 For added visibility, the area of the crosswalk may be marked with white diagonal lines at a 45-degree angle to the line of the crosswalk or with white longitudinal lines parallel to traffic flow as shown in Figure 3B-19.
- 14 When diagonal or longitudinal lines are used to mark a crosswalk, the transverse crosswalk lines may be omitted. This type of marking may be used at locations where substantial numbers of pedestrians cross without any other traffic control device, at locations where physical conditions are such that added visibility of the crosswalk is desired, or at places where a pedestrian crosswalk might not be expected.

*Guidance:*

- 15 *If used, the diagonal or longitudinal lines should be 12 to 24 inches wide and separated by gaps of 12 to 60 inches. The design of the lines and gaps should avoid the wheel paths if possible, and the gap between the lines should not exceed 2.5 times the width of the diagonal or longitudinal lines.*

## Option:

- 16 When an exclusive pedestrian phase that permits diagonal crossing of an intersection is provided at a traffic control signal, a marking as shown in Figure 3B-20 may be used for the crosswalk.

*Guidance:*

- 17 *Crosswalk markings should be located so that the curb ramps are within the extension of the crosswalk markings.*

## Support:

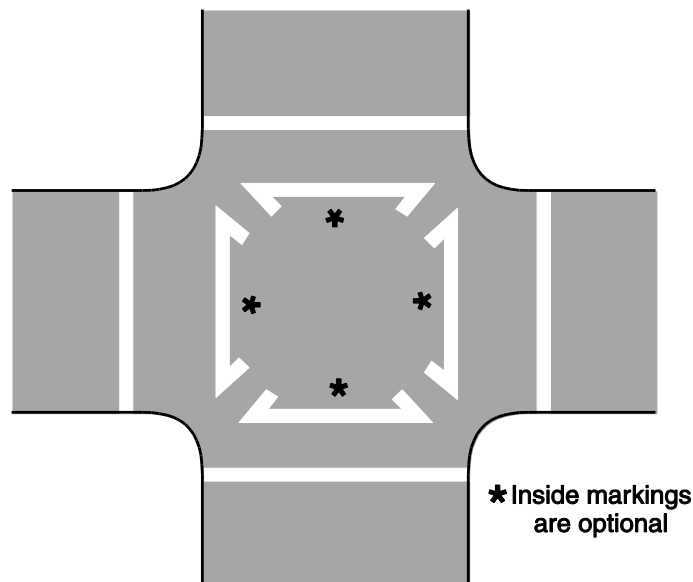
- 18 Detectable warning surfaces mark boundaries between pedestrian and vehicular ways where there is no raised curb. Detectable warning surfaces are required by 49 CFR, Part 37 and by the Americans with Disabilities Act (ADA) where curb ramps are constructed at the junction of sidewalks and the roadway, for marked and unmarked crosswalks. Detectable warning surfaces contrast visually with adjacent walking surfaces, either light-on-dark, or dark-on-light. The "Americans with Disabilities Act Accessibility Guidelines for Buildings and Facilities (ADAAG)" (see [Section 1A.11 of this Supplement](#)) contains specifications for design and placement of detectable warning surfaces.

## Support:

- 19 Information regarding guidelines and recommendations for crosswalk markings can be found in VDOT's "Guidelines for the Installation of Marked Crosswalks" (see link in Appendix A of this Supplement).



**Figure 3B-20. Example of Crosswalk Markings for an Exclusive Pedestrian Phase that Permits Diagonal Crossing**



## **Section 3B.19 Parking Space Markings**

Support:

- 01 Marking of parking space boundaries encourages more orderly and efficient use of parking spaces where parking turnover is substantial. Parking space markings tend to prevent encroachment into fire hydrant zones, bus stops, loading zones, approaches to intersections, curb ramps, and clearance spaces for islands and other zones where parking is restricted. Examples of parking space markings are shown in Figure 3B-21.

**Standard:**

- 02 **Parking space markings shall be white.**

Option:

- 03 Blue lines may supplement white parking space markings of each parking space designated for use only by persons with disabilities.

Support:

- 04 Additional parking space markings for the purpose of designating spaces for use only by persons with disabilities are discussed in [Section 3B.20 of this Supplement](#) and illustrated in [Figure 3B-22\(VA\) in this Supplement](#). The design and layout of accessible parking spaces for persons with disabilities is provided in the "Americans with Disabilities Act Accessibility Guidelines (ADAAG)" (see [Section 1A.11 of this Supplement](#)).

**Standard:**

- 05 **The International Symbol of Accessibility Parking Space Marking shall be 41 inches in height and 36 inches in width, as shown in Figure 3B-22(VA) in this Supplement. A 4-inch stroke width shall be used for the symbol lines.**

## **Section 3B.20 Pavement Word, Symbol, and Arrow Markings**

**Support:**

- 01 Word, symbol, and arrow markings on the pavement are used for the purpose of guiding, warning, or regulating traffic. These pavement markings can be helpful to road users in some locations by supplementing signs and providing additional emphasis for important regulatory, warning, or guidance messages, because the markings do not require diversion of the road user's attention from the roadway surface. Symbol messages are preferable to word messages. Examples of standard word and arrow pavement markings are shown in Figures 3B-23 and 3B-24(VA) in this Supplement.

**Option:**

- 02 Word, symbol, and arrow markings, including those contained in the "Standard Highway Signs and Markings" book (see [Section 1A.11 of this Supplement](#)), may be used as determined by engineering judgment to supplement signs and/or to provide additional emphasis for regulatory, warning, or guidance messages. Among the word, symbol, and arrow markings that may be used are the following:

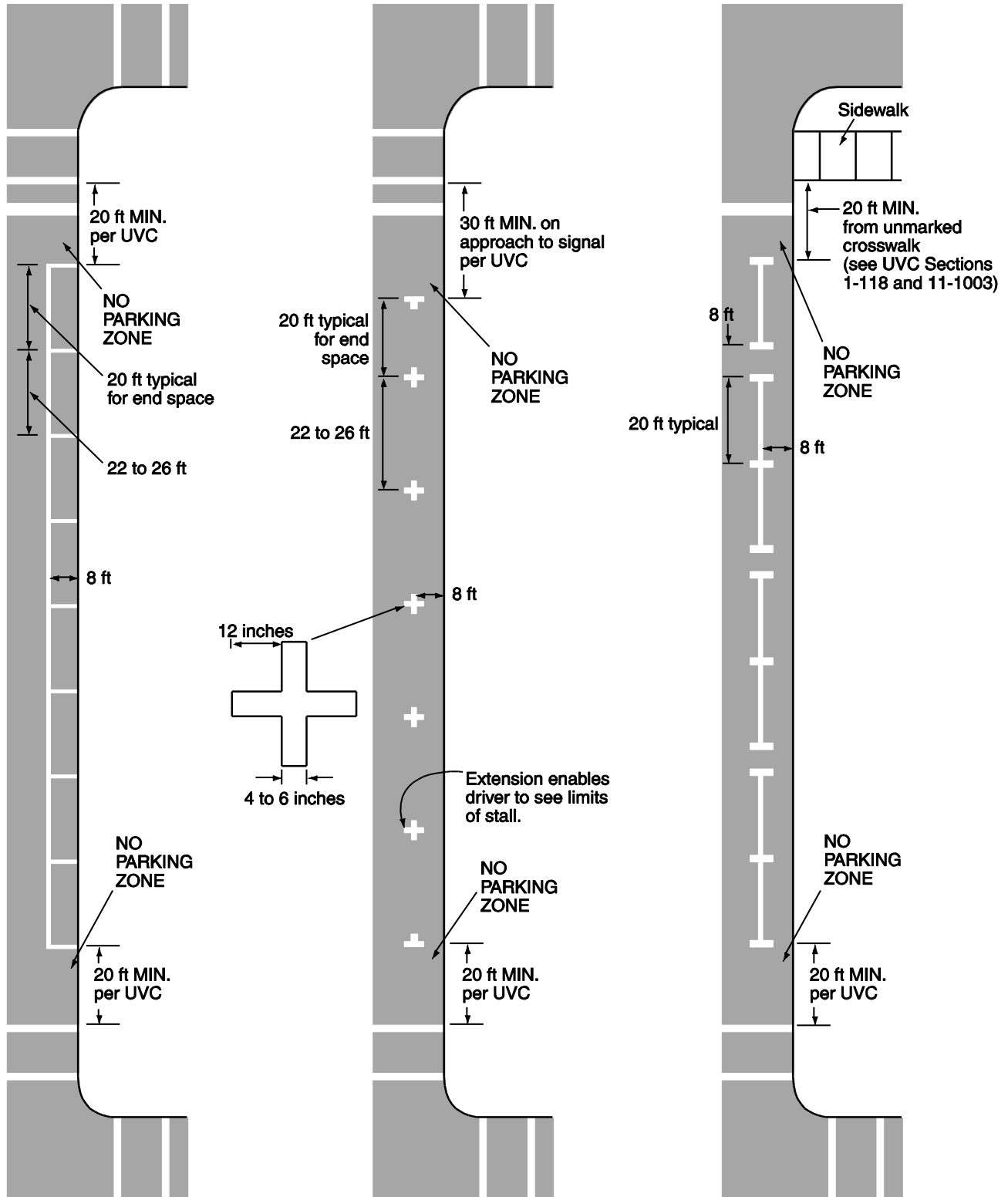
**A. Regulatory:**

1. STOP
2. YIELD
3. RIGHT (LEFT) TURN ONLY
4. 25 MPH
5. Lane-use and wrong-way arrows
6. Diamond symbol for HOV lanes
7. Other preferential lane word markings

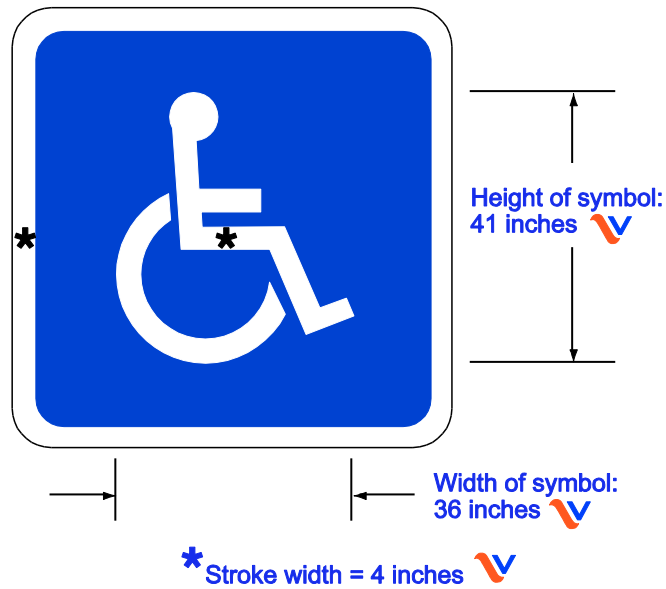
**B. Warning:**

1. STOP AHEAD
2. YIELD AHEAD
3. YIELD AHEAD triangle symbol
4. SCHOOL XING
5. SIGNAL AHEAD
6. PED XING
7. SCHOOL
8. R X R

### Figure 3B-21. Examples of Parking Space Markings



## Figure 3B-22(VA). International Symbol of Accessibility Parking Space Marking



Note: Blue background and white border are optional

9. BUMP
  10. HUMP
  11. Lane-reduction arrows
- C. Guide:
1. Route numbers (route shield pavement marking symbols and/or words such as I-81, US 40, STATE 135, or ROUTE 10)
  2. Cardinal directions (NORTH, SOUTH, EAST, or WEST)
  3. TO
  4. Destination names or abbreviations thereof

### Standard:

- 03 **Word, symbol, and arrow markings shall be white, except as otherwise provided in this Section.**
- 04 **Pavement marking letters, numerals, symbols, and arrows shall be installed in accordance with the design details in the Pavement Markings chapter of the "Standard Highway Signs and Markings" book (see [Section 1A.11 of this Supplement](#)).**



## Figure 3B-23. Example of Elongated Letters for Word Pavement Markings



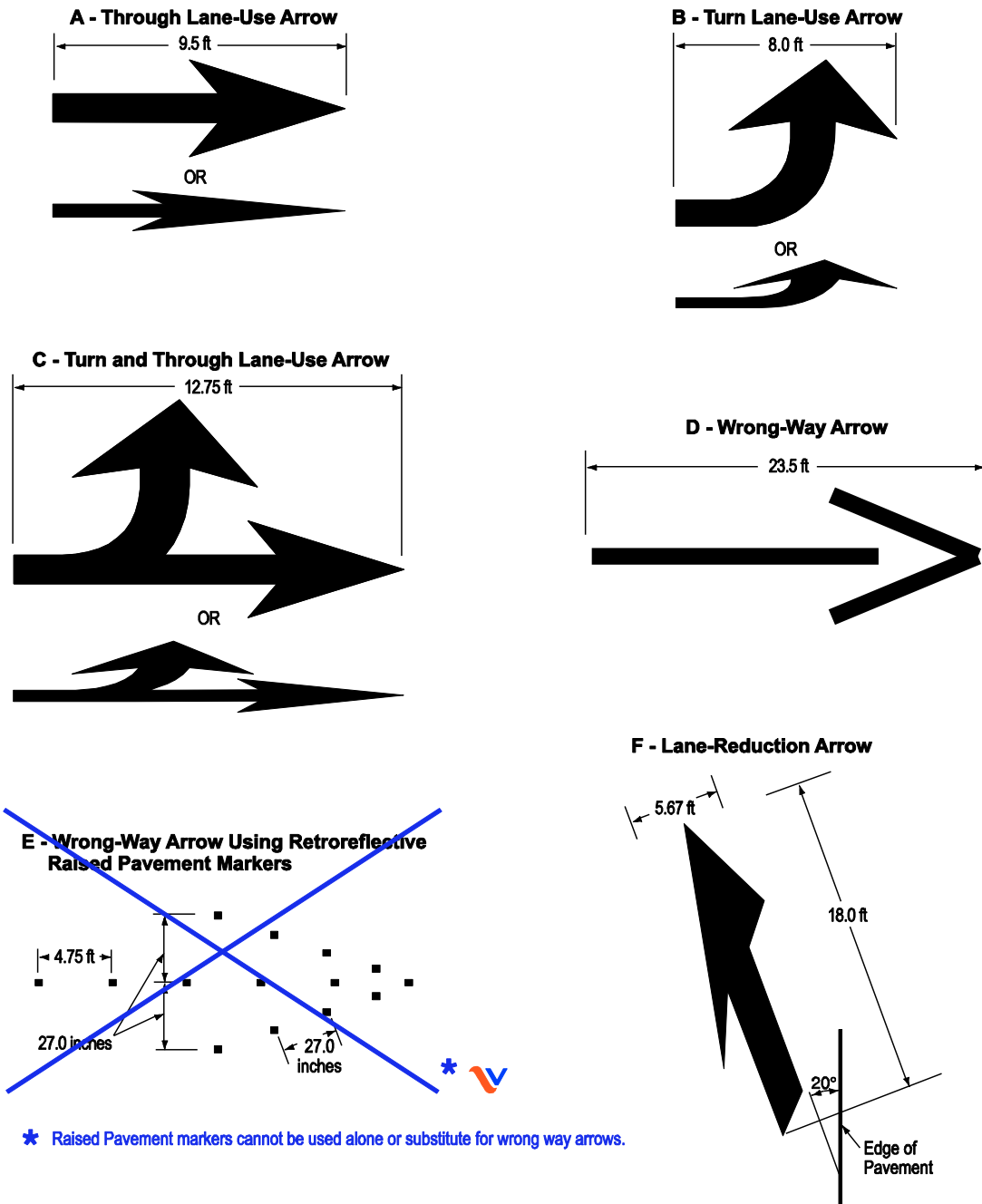
### Guidance:

- 05 *Letters and numerals should be 6 feet or more in height.*
- 06 *Word and symbol markings should not exceed three lines of information.*
- 07 *If a pavement marking word message consists of more than one line of information, it should read in the direction of travel. The first word of the message should be nearest to the road user.*
- 08 *Except for the two opposing arrows of a two-way left-turn lane marking (see Figure 3B-7), the longitudinal space between word or symbol message markings, including arrow markings, should be at least four times the height of the characters for low-speed roads, but not more than ten times the height of the characters under any conditions.*
- 09 *The number of different word and symbol markings used should be minimized to provide effective guidance and avoid misunderstanding.*
- 10 *Except for the SCHOOL word marking (see [Section 7C.03 of the MUTCD](#)), pavement word, symbol, and arrow markings should be no more than one lane in width.*
- 11 *Pavement word, symbol, and arrow markings should be proportionally scaled to fit within the width of the facility upon which they are applied.*

### Option:

- 12 *On narrow, low-speed shared-use paths, the pavement words, symbols, and arrows may be smaller than suggested, but to the relative scale.*
- 13 *Pavement markings simulating Interstate, U.S., State, and other official highway route shield signs (see [Figure 2D-3\(VA\) in this Supplement](#)) with appropriate route numbers, but elongated for proper proportioning when viewed as a marking, may be used to guide road users to their destinations (see Figure 3B-25).*

**Figure 3B-24(VA). Examples of Standard Arrows for Pavement Markings**



\* Raised Pavement markers cannot be used alone or substitute for wrong way arrows.

**Notes:**

1. Typical sizes for normal installation; sizes may be reduced approximately one-third for low-speed urban conditions; larger sizes may be needed for freeways, above average speeds, and other critical locations.
2. The narrow elongated arrow designs shown in Drawings A, B, and C are optional.
3. For proper proportion, see the Pavement Markings chapter of the "Standard Highway Signs and Markings" book (see Section 1A.11).

**Standard:**

- 14 **Except at the ends of aisles in parking lots, the word STOP shall not be used on the pavement unless accompanied by a stop line (see [Section 3B.16 in this Supplement](#)) and STOP sign (see [Section 2B.05 of the MUTCD](#)). At the ends of aisles in parking lots, the word STOP shall not be used on the pavement unless accompanied by a stop line.**
- 15 **The word STOP shall not be placed on the pavement in advance of a stop line, unless every vehicle is required to stop at all times.**

## Option:

- 16 A yield-ahead triangle symbol (see Figure 3B-26) or YIELD AHEAD word pavement marking may be used on approaches to intersections where the approaching traffic will encounter a YIELD sign at the intersection.

**Standard:**

- 17 **The yield-ahead triangle symbol or YIELD AHEAD word pavement marking shall not be used unless a YIELD sign (see [Section 2B.08 of the MUTCD](#)) is in place at the intersection. The yield-ahead symbol marking shall be as shown in Figure 3B-26.**

*Guidance:*

- 18 *The International Symbol of Accessibility parking space marking (see [Figure 3B-22\(VA\) in this Supplement](#)) should be placed in each parking space designated for use by persons with disabilities.*

## Option:

- 19 A blue background with white border may supplement the wheelchair symbol as shown in [Figure 3B-22\(VA\) in this Supplement](#).

## Support:

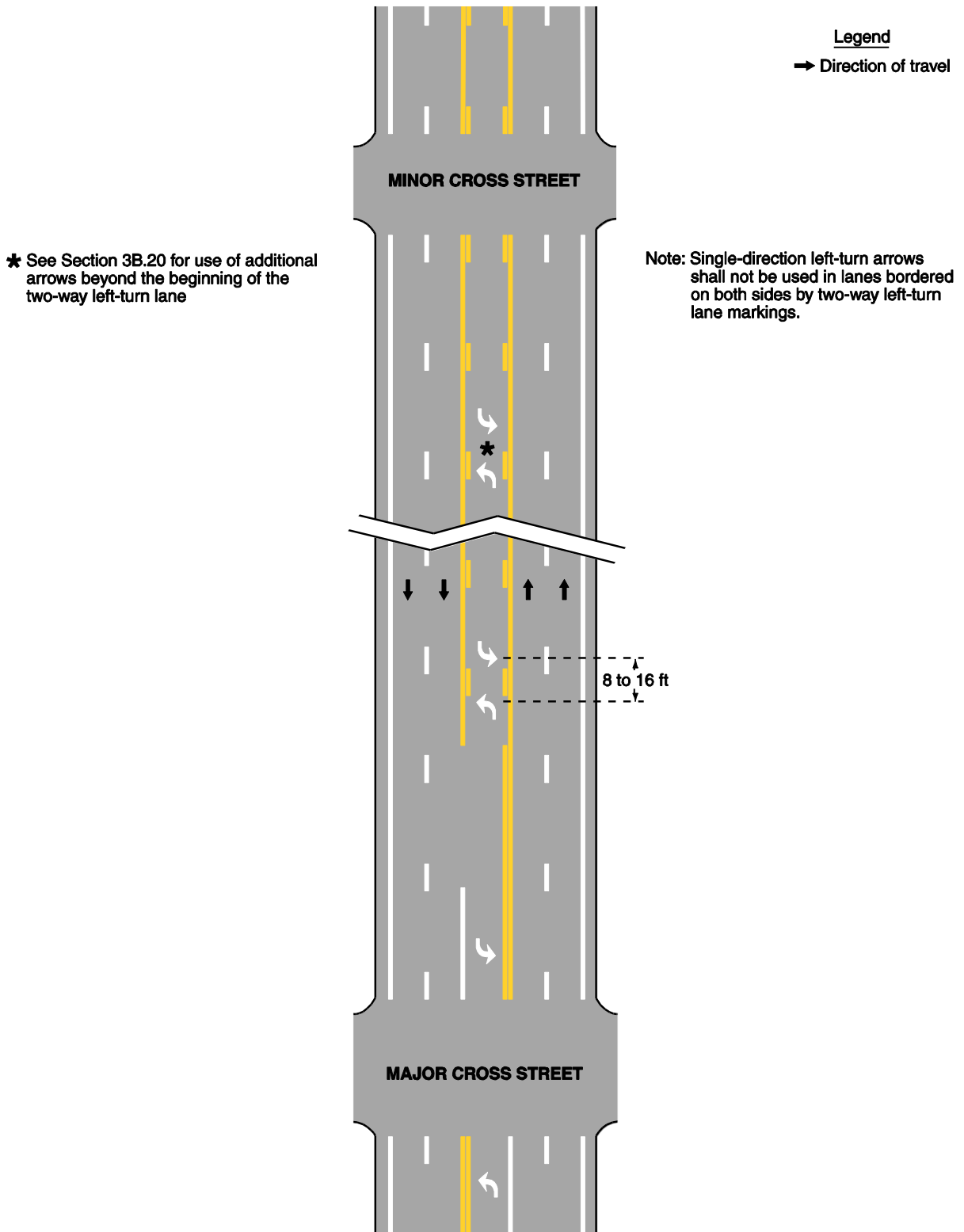
- 20 Lane-use arrow markings (see [Figure 3B-24\(VA\) in this Supplement](#)) are used to indicate the mandatory or permissible movements in certain lanes (see [Figure 3B-27\(VA\) in this Supplement](#)) and in two-way left-turn lanes (see Figure 3B-7).

*Guidance:*

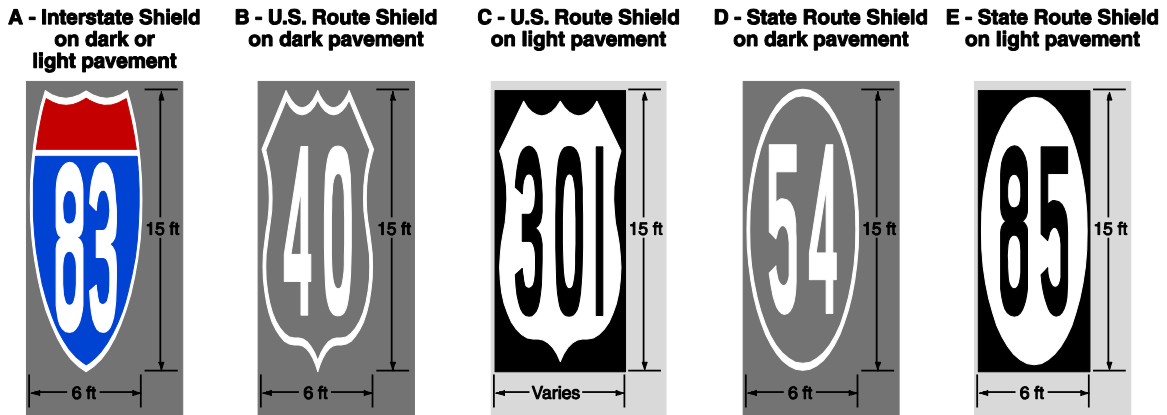
- 21 *Lane-use arrow markings (see [Figure 3B-24\(VA\) in this Supplement](#)) should be used in lanes designated for the exclusive use of a turning movement, including turn bays, except where engineering judgment determines that physical conditions or other markings (such as a dotted extension of the lane line through the taper into the turn bay) clearly discourage unintentional use of a turn bay by through vehicles. Lane-use arrow markings should also be used in lanes from which movements are allowed that are contrary to the normal rules of the road (see [Drawing B of Figure 3B-13\(VA\) in this Supplement](#)).*
- 22 *When used in turn lanes 300 feet in length or less, exclusive of taper, two arrows should be placed, one at the upstream end of the full-width turn lane and one located 50 feet upstream from the stop line, except as provided in Paragraph 24. When used in turn lanes greater than 300 feet in length, exclusive of taper, an additional arrow should be placed at the midpoint of the two arrows used in shorter turn lanes.*



### Figure 3B-7. Example of Two-Way, Left-Turn Lane Marking Applications



## Figure 3B-25. Examples of Elongated Route Shields for Pavement Markings



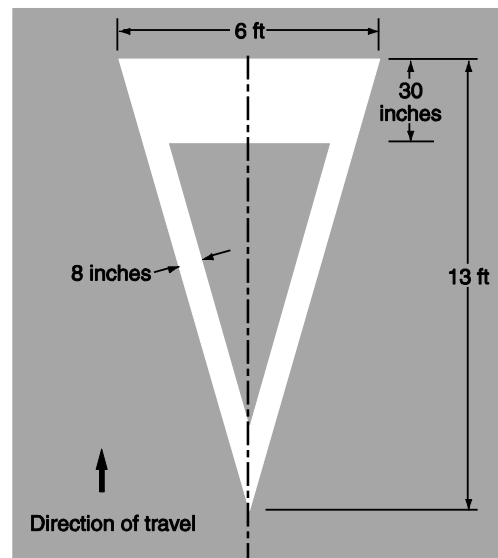
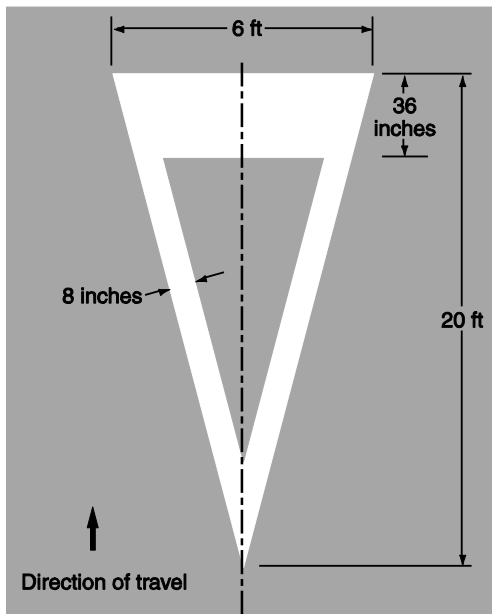
**Notes:**

1. See the "Standard Highway Signs and Markings" book for other sizes and details
2. Colors and elongated shapes simulating State route shield signs may be used for route shield pavement markings where appropriate

## Figure 3B-26. Yield Ahead Triangle Symbols

**A - Posted or Statutory Speed Limit of 45 mph or greater**

**B - Posted or Statutory Speed Limit of less than 45 mph**



**Support:**

- 23 [Figure 3B-11\(VA\)](#) in this Supplement shows examples of lane-use control and arrow pavement markings.

**Option:**

- 24 An additional arrow or arrows may be used in a turn lane. When arrows are used for a short turn lane, the second (downstream) arrow may be omitted based on engineering judgment.

**Guidance:**

- 25 *Where opposing offset channelized left-turn lanes exist, lane-use arrow markings should be placed near the downstream terminus of the offset left-turn lanes to reduce wrong-way movements (see Figure 2B-17 of the MUTCD).*

**Support:**

- 26 An arrow at the downstream end of a turn lane can help to prevent wrong way movements.

**Standard:**

- 27 **Where through lanes approaching an intersection become mandatory turn lanes, lane-use arrow markings (see Figure 3B-24(VA) in this Supplement) shall be used and shall be accompanied by standard signs. Where through lanes approaching an intersection become mandatory turn lanes, ONLY word markings (see Figure 3B-23) shall be used in addition to the required lane-use arrow markings and signs (see Sections 2B.19 and 2B.20 of the MUTCD).**

**Guidance:**

- 28 *These markings and signs should be placed well in advance of the turn and should be repeated as necessary to prevent entrapment and to help the road user select the appropriate lane in advance of reaching a queue of waiting vehicles (see Figure 3B-11(VA) in this Supplement).*

- 29 *Where dual turn lanes exist, ONLY word markings (see Figure 3B-23) should be used in addition to the required lane-use arrow markings and signs (see Sections 2B.19 and 2B.20 of the MUTCD). These markings and signs should be placed and repeated as necessary to help the road user select the appropriate lane in advance of reaching a queue of waiting vehicles.*

**Option:**

- 30 On freeways or expressways where a through lane becomes a mandatory exit lane, lane-use arrow markings may be used on the approach to the exit in the dropped lane and in an adjacent optional through-or-exit lane if one exists.

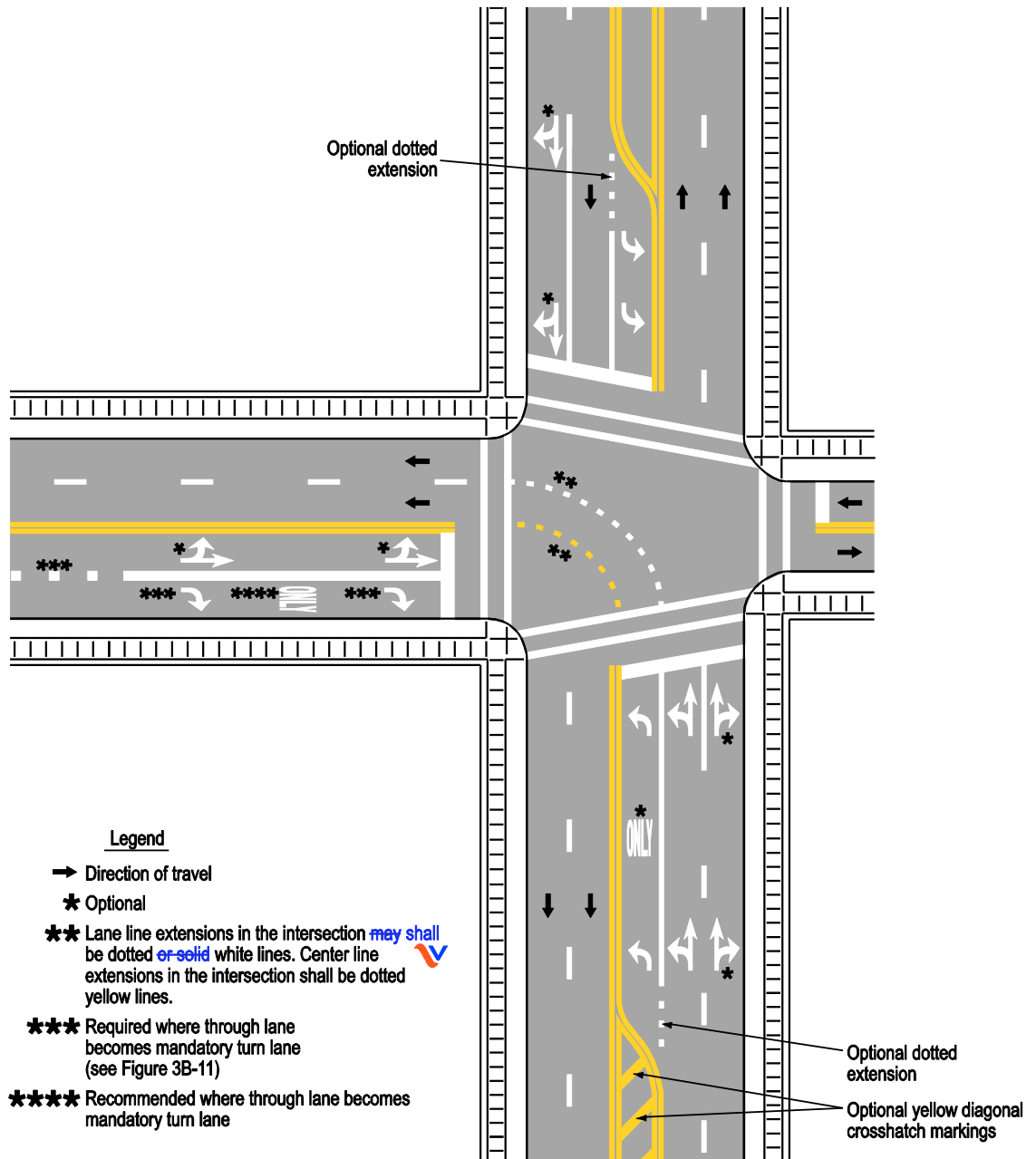
**Guidance:**

- 31 *A two-way left-turn lane-use arrow pavement marking, with opposing arrows spaced as shown in Figure 3B-7, should be used at or just downstream from the beginning of a two-way left-turn lane.*

**Option:**

- 32 Additional two-way left-turn lane-use arrow markings may be used at other locations along a two-way left-turn lane where engineering judgment determines that such additional markings are needed to emphasize the proper use of the lane.

**Figure 3B-27(VA). Examples of Lane-Use Control Word and Arrow Pavement Markings**



**Standard:**

- 33 **A single-direction lane-use arrow shall not be used in a lane bordered on both sides by yellow two-way left-turn lane longitudinal markings.**
- 34 **Lane-use, lane-reduction, and wrong-way arrow markings shall be designed as shown in [Figure 3B-24\(VA\)](#) in this Supplement and in the "Standard Highway Signs and Markings" and "Virginia Standard Highway Signs" books (see [Section 1A.11](#) of this Supplement).**

## Option:

- 35 The ONLY word marking (see [Figure 3B-23](#)) may be used to supplement the lane-use arrow markings in lanes that are designated for the exclusive use of a single movement (see [Figure 3B-27\(VA\)](#) in this Supplement) or to supplement a preferential lane word or symbol marking (see [Section 3D.01](#) of this Supplement).

**Standard:**

- 36 **The ONLY word marking shall not be used in a lane that is shared by more than one movement.**



- 37 **Where a lane-reduction transition occurs on a roadway with a speed limit of 45 mph or more, the lane-reduction arrow markings shown in [Drawing F](#) in [Figure 3B-24\(VA\)](#) in this Supplement shall be used (see [Figure 3B-14](#)).**

*Guidance:*

- 38 *Except for acceleration lanes, where a lane-reduction transition occurs on a roadway with a speed limit of less than 45 mph, the lane-reduction arrow markings shown in [Drawing F](#) in [Figure 3B-24\(VA\)](#) in this Supplement should be used if determined to be appropriate based on engineering judgment.*

**Standard:**

- 39 **Where crossroad channelization or ramp geometrics do not make wrong-way movements difficult, the appropriate lane-use arrow shall be placed in each lane of an exit ramp near the crossroad terminal where it will be clearly visible to a potential wrong-way road user (see [Figure 2B-18\(VA\)](#) in this Supplement).**
- 40 **The wrong-way arrow markings shown in [Drawing D](#) in [Figure 3B-24\(VA\)](#) in this Supplement shall be placed near the downstream terminus of a ramp (see [Figure 2B-18\(VA\)](#) in this Supplement).**

## Option:

- 41 Wrong-way arrow markings may be placed at other locations where lane-use arrows are not appropriate, to indicate the correct direction of traffic flow and to discourage drivers from traveling in the wrong direction.

## Section 3B.21 Speed Measurement Markings

## Support:

- 01 A speed measurement marking is a transverse marking placed on the roadway to assist the enforcement of speed regulations.





- 02 The Virginia General Assembly enacted legislation, effective July 1, 2000, amending § 46.2-882 of the Code of Virginia to allow the use of aircraft for enforcement of the speed limit on interstate highways. Speed measurement markings are used by the Virginia State Police with the Visual Average Speed Computer and Monitor (VASCAR) units within aircraft as a point of reference to determine the speed of vehicles.

**Standard:**

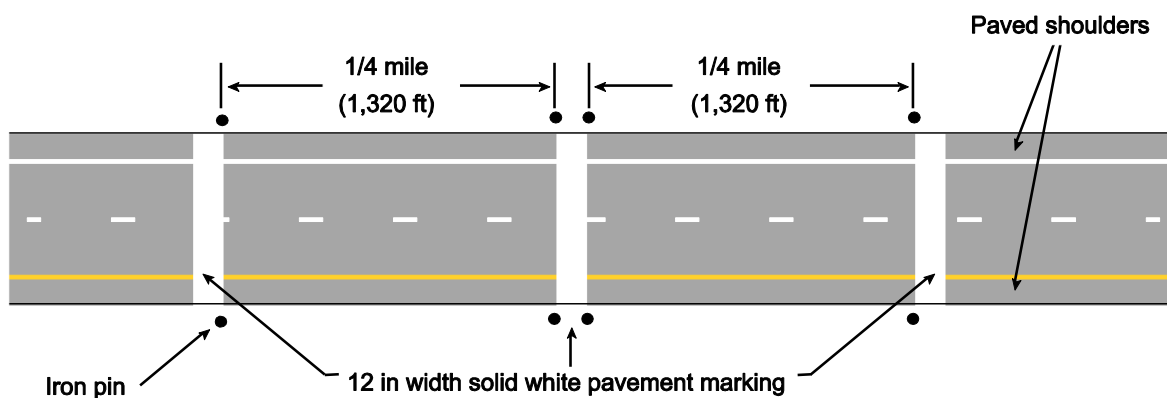
- 03 **Speed measurement markings shall be solid white and shall be 12 inches wide, extending between the edges of the pavement on either side of the roadway. The markings shall be installed according to Figure 3B-V3 in this Supplement at locations on interstate highways determined by the Virginia State Police.**
- 04 **The location of the pavement marking at each site shall be determined using iron pins located as shown in Figure 3B-V3 in this Supplement. The pin locations shall be determined with survey equipment that will provide accuracy within three to five hundredths of a foot for each pin location. Pin locations shall be one foot from the paved shoulder at the locations shown in Figure 3B-V3 in this Supplement. When the paved shoulder continues to a barrier, etc., the pin shall be located as close to the barrier, etc. as possible. The edge of pavement markings shall align with the center of the iron pins on both sides of the roadway**

**Support:**

- 05 See Section 2B-V3 of this Supplement for regulatory signs that are used at or near the State boundary and after major interchanges.



**Figure 3B-V3. Pavement Marking Detail Aerial Speed Enforcement**



## Section 3B.24 Chevron and Diagonal Crosshatch Markings

Option:

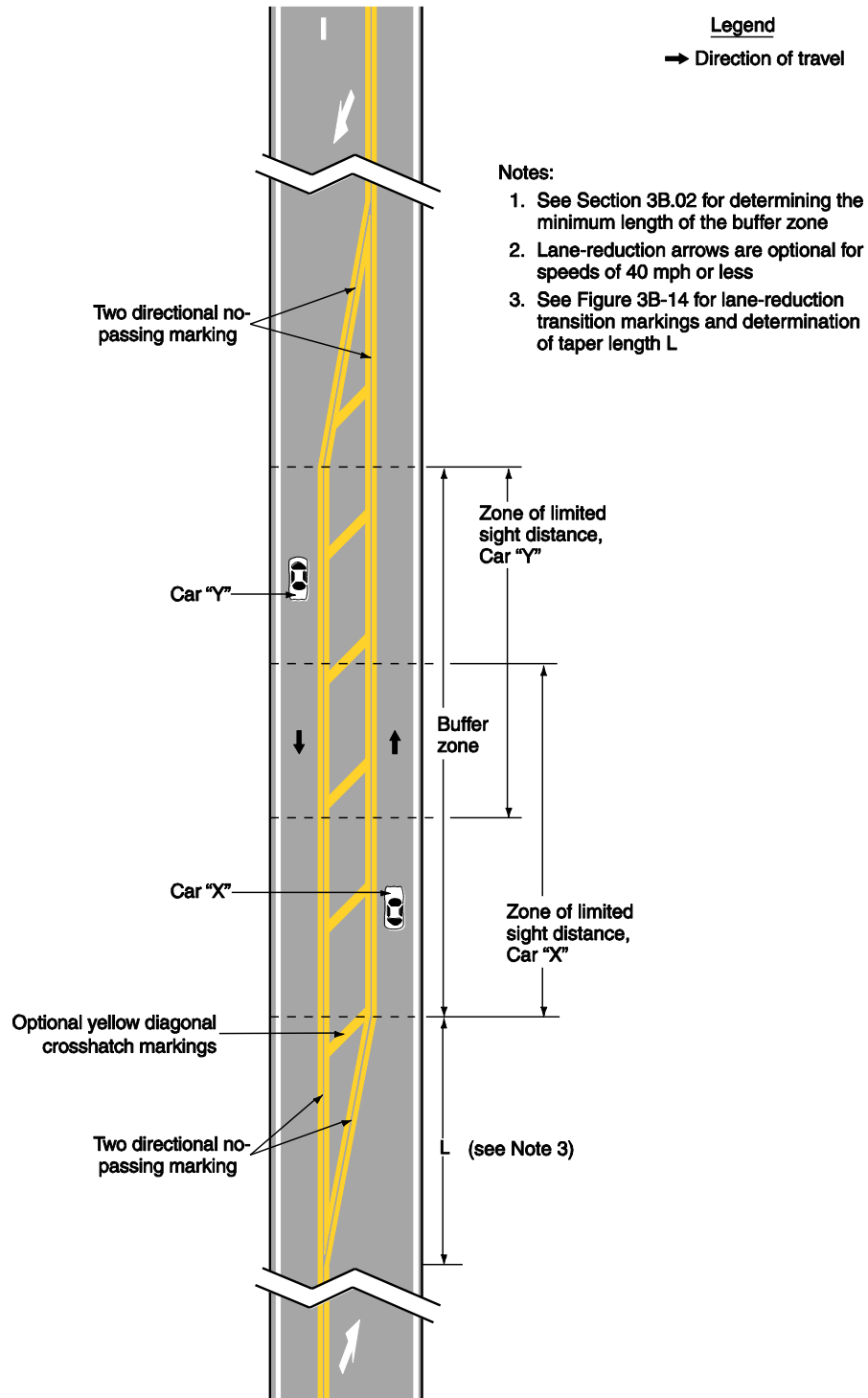
- 01 Chevron and diagonal crosshatch markings may be used to discourage travel on certain paved areas, such as shoulders, gore areas, flush median areas between solid double yellow center line markings or between white channelizing lines approaching obstructions in the roadway (see [Section 3B.10 of the MUTCD](#) and Figure 3B-15), between solid double yellow center line markings forming flush medians or channelized travel paths at intersections (see Figures 3B-2 and 3B-5), buffer spaces between preferential lanes and general-purpose lanes (see [Figures 3D-2\(VA\) in this Supplement](#) and 3D-4), and at grade crossings (see Part 8).

**Standard:**

- 02 **When crosshatch markings are used in paved areas that separate traffic flows in the same general direction, they shall be white and they shall be shaped as chevron markings, with the point of each chevron facing toward approaching traffic, as shown in [Figure 3B-8\(VA\)](#), Drawing A of [Figure 3B-9\(VA\)](#), [Figure 3B-10\(VA\) in this Supplement](#), and Drawing C of Figure 3B-15.**
- 03 **When crosshatch markings are used in paved areas that separate opposing directions of traffic, they shall be yellow diagonal markings that slant away from traffic in the adjacent travel lanes, as shown in Figures 3B-2 and 3B-5 and Drawings A and B of Figure 3B-15.**
- 04 **When crosshatch markings are used on paved shoulders, they shall be diagonal markings that slant away from traffic in the adjacent travel lane. The diagonal markings shall be yellow when used on the left-hand shoulders of the roadways of divided highways and on the left-hand shoulders of one-way streets or ramps. The diagonal markings shall be white when used on right-hand shoulders.**
- 05 **The chevrons and diagonal lines used for crosshatch markings shall be at least 12 inches wide for roadways having a posted or statutory speed limit of 45 mph or greater, and at least 8 inches wide for roadways having posted or statutory speed limit of less than 45 mph. The longitudinal spacing of the chevrons or diagonal lines shall be determined by engineering judgment considering factors such as speeds and desired visual impacts. The chevrons and diagonal lines shall form approximately a 45-degree angle with the longitudinal lines that they intersect.**
- 06 **On limited access highways, the chevrons and diagonal lines used for crosshatch markings shall be at least 24 inches wide. The longitudinal spacing of the chevrons or diagonal lines shall be three times the width of the crosshatch markings (see [Figure 3B-V4 in this Supplement](#)).**

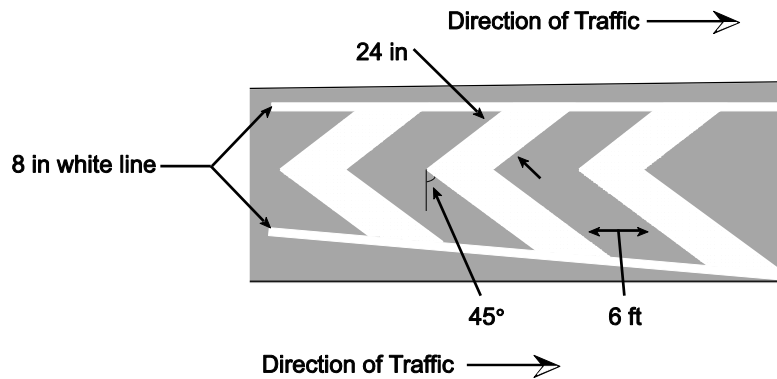


**Figure 3B-5. Example of Application of Three-Lane, Two-Way Marking for Changing Direction of the Center Lane**





## Figure 3B-V4. Chevron Cross Hatch Marking for Limited-Access Highways



## Section 3B.V1 Breaks in Longitudinal Lines at Intersections

**Standard:**\*

Guidance:

- 9901 Breaks in center line markings, lane line markings, edge line markings, and other longitudinal markings **shall should\*** be made only at intersections with public roads. Breaks **shall should\*** be of sufficient length to accommodate traffic entering and leaving the side road.

# CHAPTER 3D: MARKINGS FOR PREFERENTIAL LANES

## Section 3D.01 Preferential Lane Word and Symbol Markings

Support:

- 01 Preferential lanes are established for one or more of a wide variety of special uses, including, but not limited to, high-occupancy vehicle (HOV) lanes, ETC lanes, high-occupancy toll (HOT) lanes, bicycle lanes, bus only lanes, taxi only lanes, and light rail transit only lanes.

Standard:

- 02 When a lane is assigned full or part time to a particular class or classes of vehicles, the preferential lane word and symbol markings described in this Section and the preferential lane longitudinal markings described in [Section 3D.02 of this Supplement](#) shall be used.
- 03 All longitudinal pavement markings, as well as word and symbol pavement markings, associated with a preferential lane shall end where the Preferential Lane Ends (R3-12a or R3-12c) sign (see [Section 2G.07 of the MUTCD](#)) designating the downstream end of the preferential only lane restriction is installed.
- 04 Static or changeable message regulatory signs (see [Sections 2G.03 to 2G.07 of the MUTCD](#)) shall be used with preferential lane word or symbol markings.
- 05 All preferential lane word and symbol markings shall be white and shall be positioned laterally in the center of the preferential lane.
- 06 Where a preferential lane use exists contiguous to a general-purpose lane or is separated from a general purpose lane by a flush buffered space that can be traversed by motor vehicles, the preferential lane shall be marked with one or more of the following symbol or word markings for the preferential lane use specified:
- A. HOV lane—the preferential lane-use marking for high-occupancy vehicle lanes shall consist of white lines formed in a diamond shape symbol ~~or the word message~~ **HOV**. The diamond shall be at least 2.5 feet wide and 12 feet in length. The lines shall be at least 6 inches in width.
  - B. HOT lane or ETC Account-Only lane—except as provided in Paragraph 8, the preferential lane-use marking for a HOT lane or an ETC Account-Only lane shall consist of a word marking using the name of the ETC payment system required for use of the lane, such as E-Z PASS ONLY.
  - C. Bicycle lane—the preferential lane-use marking for a bicycle lane shall consist of a ~~bicycle~~ **helmeted bicyclist\*** symbol ~~or the word marking BIKE LANE~~ (see Chapter 9C and [Figures 9C-1\(VA\) and 9C-3\(VA\) through 9C-6\(VA\) in this Supplement](#)).



- D. **Bus only lane**—the preferential lane-use marking for a bus only lane shall consist of the word marking **BUS ONLY**.
  - E. **Taxi only lane**—the preferential lane-use marking for a taxi only lane shall consist of the word marking **TAXI ONLY**.
  - F. **Light rail transit lane**—the preferential lane-use marking for a light rail transit lane shall consist of the word marking **LRT ONLY**.
  - G. **Other type of preferential lane**—the preferential lane-use markings shall consist of a word marking appropriate to the restriction.
- 07 **If two or more preferential lane uses are permitted in a single lane, the symbol or word marking for each preferential lane use shall be installed.**

**Option:**

- 08 For HOV lanes and bicycle lanes, the word messages may be used to supplement symbol markings on a limited basis if engineering judgment determines a need for them. Such circumstances include new installations of the preferential lane type in a new area of Virginia where drivers may be less familiar with the meaning of the symbols.
- 09 Preferential lane-use symbol or word markings may be omitted at toll plazas where physical conditions preclude the use of the markings (see [Section 3E.01 of the MUTCD](#)).

*Guidance:*

- 10 *The spacing of the markings should be based on engineering judgment that considers the prevailing speed, block lengths, distance from intersections, and other factors that affect clear communication to the road user.*

**Support:**

- 11 Markings spaced as close as 80 feet apart might be appropriate on city streets, while markings spaced as far as 1,000 feet apart might be appropriate for freeways.

*Guidance:*

- 12 *In addition to a regular spacing interval, the preferential lane marking should be placed at strategic locations such as major decision points, direct exit ramp departures from the preferential lane, and along access openings to and from adjacent general-purpose lanes. At decision points, the preferential lane marking should be placed on all applicable lanes and should be visible to approaching traffic for all available departures. At direct exits from preferential lanes where extra emphasis is needed, the use of word markings (such as "EXIT" or "EXIT ONLY") in the deceleration lane for the direct exit and/or on the direct exit ramp itself just beyond the exit gore should be considered.*

**Option:**

- 1413 A numeral indicating the vehicle occupancy requirements established for a high-occupancy vehicle lane may be included in sequence after the diamond symbol or HOV word message.

*Guidance:*

- 1514 *Engineering judgment should determine the need for supplemental devices such as tubular markers, traffic cones, or other channelizing devices (see Chapter 3H).*



## **Section 3D.02 Preferential Lane Longitudinal Markings for Motor Vehicles**

### **Support:**

- 01 Preferential lanes can take many forms depending on the level of usage and the design of the facility. They might be barrier-separated or buffer-separated from the adjacent general-purpose lanes, or they might be contiguous with the adjacent general-purpose lanes. Barrier-separated preferential lanes might be operated in a constant direction or be operated as reversible lanes. Some reversible preferential lanes on a divided highway might be operated counter-flow to the direction of traffic on the immediately adjacent general purpose lanes. See [Section 1A.13 of this Supplement](#) for definitions of terms.
- 02 Preferential lanes might be operated full-time (24 hours per day on all days), for extended periods of the day, part-time (restricted usage during specific hours on specified days), or on a variable basis (such as a strategy for a managed lane).

### **Standard:**

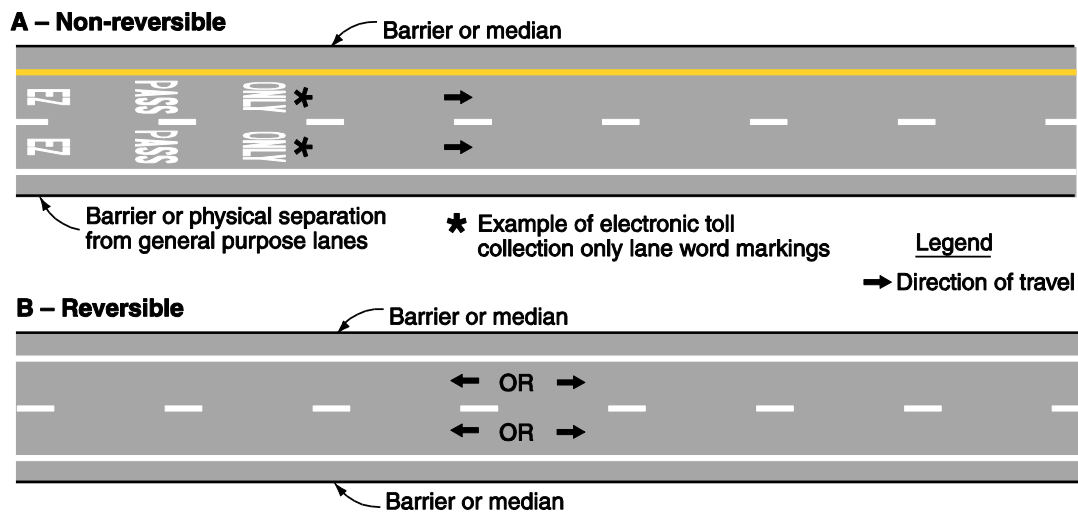
- 03 **Longitudinal pavement markings for preferential lanes shall be as follows (these same requirements are presented in tabular form in Table 3D-1):**
  - A. **Barrier-separated, non-reversible preferential lane—the longitudinal pavement markings for preferential lanes that are physically separated from the other travel lanes by a barrier or median shall consist of a normal solid single yellow line at the left-hand edge of the travel lane(s), and a normal solid single white line at the right-hand edge of the travel lane(s) (see Drawing A in Figure 3D-1).**
  - B. **Barrier-separated, reversible preferential lane—the longitudinal pavement markings for reversible preferential lanes that are physically separated from the other travel lanes by a barrier or median shall consist of a normal solid single white line at both edges of the travel lane(s) (see Drawing B in Figure 3D-1).**
  - C. **Buffer-separated (left-hand side) preferential lane—the longitudinal pavement markings for a full-time or part-time preferential lane on the left-hand side of and separated from the other travel lanes by a neutral buffer space shall consist of a normal solid single yellow line at the left-hand edge of the preferential travel lane(s) and one of the following at the right-hand edge of the preferential travel lane(s):**
    1. **A wide solid double white line along both edges of the buffer space where crossing the buffer space is prohibited (see Drawing A in [Figure 3D-2\(VA\) in this Supplement](#)).**
    2. **A wide solid single white line along both edges of the buffer space where crossing the buffer space is discouraged (see Drawing B in [Figure 3D-2\(VA\) in this Supplement](#)).**
    3. **A wide broken single white line along both edges of the buffer space, or a wide broken single white lane line within the allocated buffer space**

(resulting in wider lanes), where crossing the buffer space is permitted (see Drawing C in [Figure 3D-2\(VA\) in this Supplement](#)).

- D. Buffer-separated (right-hand side) preferential lane—the longitudinal pavement markings for a full-time or part-time preferential lane on the right-hand side of and separated from the other travel lanes by a neutral buffer space shall consist of a normal solid single white line at the right-hand edge of the preferential travel lane(s) if warranted (see [Section 3B.07 in this Supplement](#)) and one of the following at the left-hand edge of the preferential travel lane(s) (see Drawing D in [Figure 3D-2\(VA\) in this Supplement](#)):
1. A wide solid double white line along both edges of the buffer space where crossing the buffer space is prohibited.
  2. A wide solid single white line along both edges of the buffer space where crossing of the buffer space is discouraged.
  3. A wide broken single white line along both edges of the buffer space, or a wide broken single white line within the allocated buffer space (resulting in wider lanes), where crossing the buffer space is permitted.
  4. A wide dotted single white lane line within the allocated buffer space (resulting in wider lanes) where crossing the buffer space is permitted for any vehicle to perform a right-turn maneuver.
- E. Contiguous (left-hand side) preferential lane—the longitudinal pavement markings for a full-time or part-time preferential lane on the left-hand side of and contiguous to the other travel lanes shall consist of a normal solid single yellow line at the left-hand edge of the preferential travel lane(s) and one of the following at the right-hand edge of the preferential travel lane(s):
1. A wide solid double white lane line where crossing is prohibited (see Drawing A in [Figure 3D-3\(VA\) in this Supplement](#))\*.
  2. A wide solid single white lane line where crossing is discouraged (see Drawing B in [Figure 3D-3\(VA\) in this Supplement](#))\*.
  3. A wide solid single white lane line where crossing is permitted (see Drawing C in [Figure 3D-3\(VA\) in this Supplement](#))\*.
- F. Contiguous (right-hand side) preferential lane—the longitudinal pavement markings for a full-time or part-time preferential lane on the right-hand side of and contiguous to the other travel lanes shall consist of a normal solid single white line at the right-hand edge of the preferential travel lane(s) if warranted (see [Section 3B.07 of this Supplement](#)) and one of the following at the left-hand edge of the preferential travel lane(s) (see Drawing D in [Figure 3D-3\(VA\) in this Supplement](#))\*:
1. A wide solid double white lane line where crossing is prohibited.
  2. A wide solid single white lane line where crossing is discouraged.
  3. A wide broken single white lane line where crossing is permitted.
  4. A wide dotted single white lane line where crossing is permitted for any vehicle to perform a right-turn maneuver.



## Figure 3D-1. Markings for Barrier Separated Preferential Lanes



### Guidance:

- 04 Where preferential lanes and other travel lanes are separated by a buffer space, the buffer space should be a minimum of 4 feet wide. Where preferential lanes and other travel lanes are separated by a buffer space wider than 4 feet and crossing the buffer space is prohibited, chevron markings (see Section 3B.24 of this Supplement) should be placed in the buffer area (see Drawing A in Figure 3D-2(VA) in this Supplement). The chevron spacing should be 100 feet or greater.

### Option:

- 05 Tubular markers (see Chapter 3H) may be used in areas where needed to prevent drivers from entering and exiting at unauthorized locations.
- 06 If a full-time or part-time contiguous preferential lane is separated from the other travel lanes by a wide broken single white line (see Drawing C in Figure 3D-3(VA) in this Supplement)\*, the spacing or skip pattern of the line may be reduced and the width of the line may be increased.

### Standard:

- 07 If there are two or more preferential lanes for traffic moving in the same direction, the lane lines between the preferential lanes shall be normal broken white lines.
- 08 Preferential lanes for motor vehicles shall also be marked with the appropriate word or symbol pavement markings in accordance with Section 3D.01 of this Supplement and shall have appropriate regulatory signs in accordance with Sections 2G.03 through 2G.07 of the MUTCD.

### Guidance:

- 09 At direct exits from a preferential lane, dotted white line markings should be used to separate the tapered or parallel deceleration lane for the direct exit (including the taper)

*from the adjacent continuing preferential through lane, to reduce the chance of unintended exit maneuvers.*

**Standard:**

- 10 **On a divided highway, a part-time counter-flow preferential lane that is contiguous to the travel lanes in the opposing direction shall be separated from the opposing direction lanes by the standard reversible lane longitudinal marking, a normal width broken double yellow line (see [Section 3B.03 of the MUTCD](#) and Drawing A of Figure 3D-4). If a buffer space is provided between the part-time counter-flow preferential lane and the opposing direction lanes, a normal width broken double yellow line shall be placed along both edges of the buffer space (see Drawing B of Figure 3D-4). Signs (see [Section 2B.26 of the MUTCD](#)), lane-use control signals (see Chapter 4M), or both shall be used to supplement the reversible lane markings.**
- 11 **On a divided highway, a full-time counter-flow preferential lane that is contiguous to the travel lanes in the opposing direction shall be separated from the opposing direction lanes by a solid double yellow center line marking (see Drawing C of Figure 3D-4). If a buffer space is provided between the full-time counter-flow preferential lane and the opposing direction lanes, a normal width solid double yellow line shall be placed along both edges of the buffer space (see Drawing D of Figure 3D-4).**

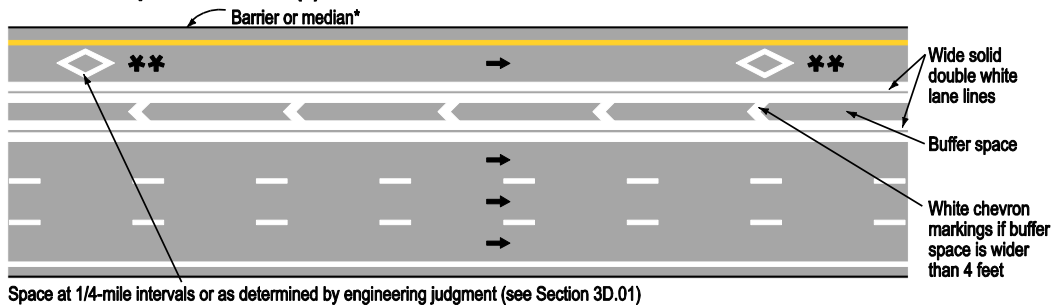
**Option:**

- 12 Cones, tubular markers, or other channelizing devices (see Chapter 3H) may also be used to separate the opposing lanes when a counter-flow preferential lane operation is in effect.

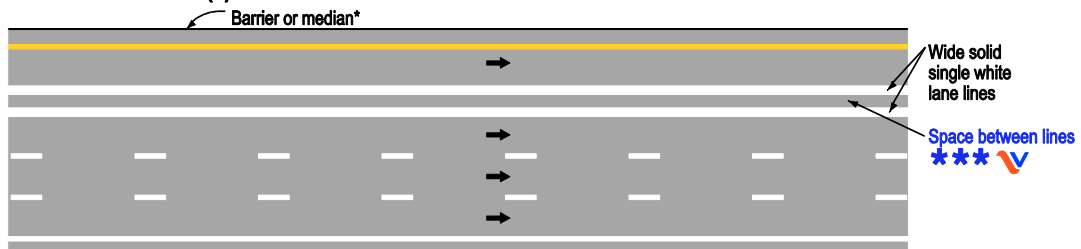
# Figure 3D-2(VA). Markings for Buffer Separated Preferential Lanes (Sheet 1 of 2)

(This Figure has been updated for the Virginia Supplement to the MUTCD – Revision 1.)\*

**A – Full-time preferential lane(s) where enter/exit movements are PROHIBITED**



**B – Preferential lane(s) where enter/exit movements are DISCOURAGED**



- Legend**
- Direction of travel
  - \* If no barrier or median is present and the left-hand side of the lane is the center line of a two-way roadway, use a double yellow center line
  - \*\* Example of HOV only lane symbol markings
  - \*\*\* Space between lines should be a minimum of 4 feet wide V

## Table 3D-1. Standard Edge Line and Lane Line Markings for Preferential Lanes

Type of Preferential Lane	Left-Hand Edge Line	Right-Hand Edge Line
<b>Barrier-Separated, Non-Reversible</b>	A normal solid single yellow line	A normal solid single white line (see Drawing A of Figure 3D-1)
<b>Barrier-Separated, Reversible</b>	A normal solid single white line	A normal solid single white line (see Drawing B of Figure 3D-1)
<b>Buffer-Separated, Left-Hand Side</b>	A normal solid single yellow line	A wide solid double white line along both edges of the buffer space where crossing is prohibited (see Drawing A of <a href="#">Figure 3D-2(VA) in this Supplement</a> ) A wide solid single white line along both edges of the buffer space where crossing is discouraged (see Drawing B of <a href="#">Figure 3D-2(VA) in this Supplement</a> ) A wide broken single white line along both edges of the buffer space, or a wide broken single white line within the buffer space (resulting in wider lanes), where crossing is permitted (see Drawing C of <a href="#">Figure 3D-2(VA) in this Supplement</a> )
<b>Buffer-Separated, Right-Hand Side</b>	A wide solid double white line along both edges of the buffer space where crossing is prohibited (see Drawing D of <a href="#">Figure 3D-2(VA) in this Supplement</a> ) A wide solid single white line along both edges of the buffer space where crossing is discouraged (see Drawing D of <a href="#">Figure 3D-2 (VA) in this Supplement</a> ) A wide broken single white line along both edges of the buffer space, or a wide broken single white line within the buffer space (resulting in wider lanes), where crossing is permitted (see Drawing D of <a href="#">Figure 3D-2(VA) in this Supplement</a> ) A wide dotted single white line within the buffer space (resulting in wider lanes) where crossing is permitted for any vehicle to perform a right-turn maneuver (see Drawing D of <a href="#">Figure 3D-2(VA) in this Supplement</a> )	A normal solid single white line (if warranted)
<b>Contiguous, Left-Hand Side</b>	A normal solid single yellow line	A wide solid double white line where crossing is prohibited (see Drawing A of <a href="#">Figure 3D-3(VA) in this Supplement</a> )* A wide solid single white line where crossing is discouraged (see Drawing B of <a href="#">Figure 3D-3(VA) in this Supplement</a> )* A wide broken single white line where crossing is permitted (see Drawing C of <a href="#">Figure 3D-3(VA) in this Supplement</a> )*
<b>Contiguous, Right-Hand Side</b>	A wide solid double white line where crossing is prohibited (see Drawing D of <a href="#">Figure 3D-3(VA) in this Supplement</a> )* A wide solid single white line where crossing is discouraged (see Drawing D of <a href="#">Figure 3D-3(VA) in this Supplement</a> )* A wide broken single white line where crossing is permitted (see Drawing D of <a href="#">Figure 3D-3(VA) in this Supplement</a> )* A wide dotted single white line where crossing is permitted for any vehicle to perform a right-turn maneuver (see Drawing D of <a href="#">Figure 3D-3(VA) in this Supplement</a> )*	A normal solid single white line

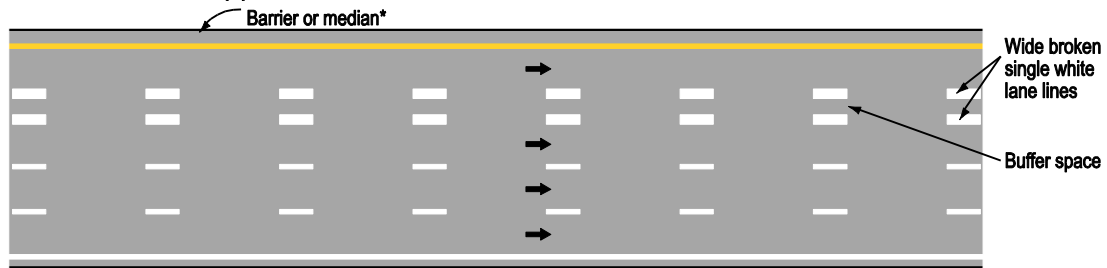
Notes:

1. If there are two or more preferential lanes, the lane lines between the preferential lanes shall be normal broken white lines.
2. The standard lane markings listed in this table are provided in a tabular format for reference.
3. This information is also described in Paragraph 3 of [Section 3D.02 in this Supplement](#).

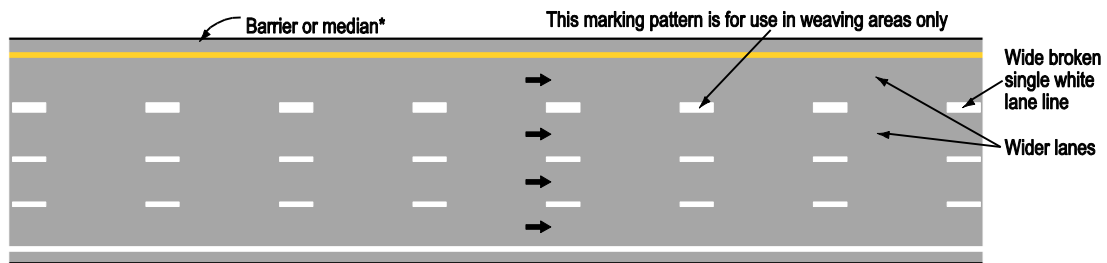
# Figure 3D-2(VA). Markings for Buffer Separated Preferential Lanes (Sheet 2 of 2)

(This Figure has been updated for the Virginia Supplement to the MUTCD – Revision 1.)\*

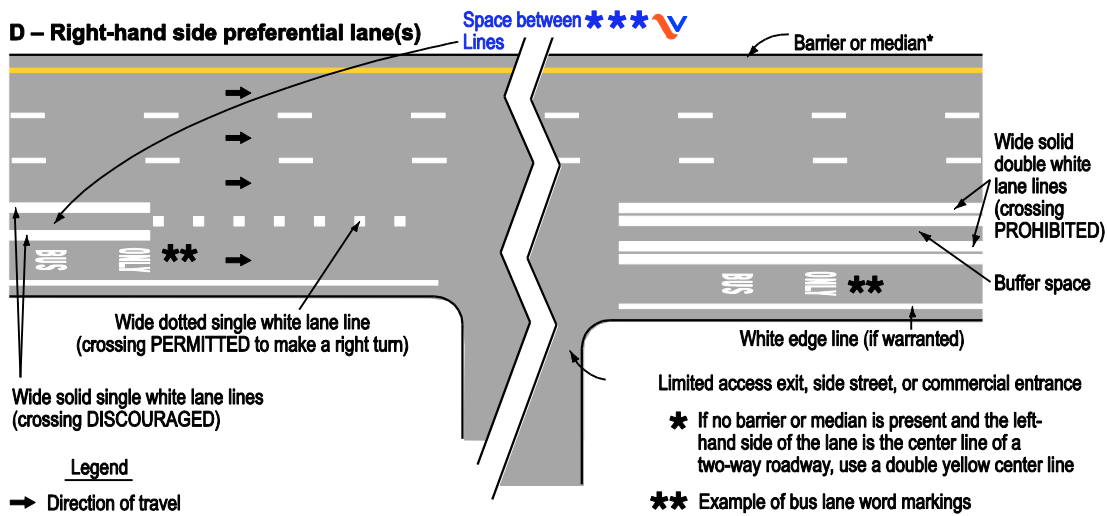
## C – Preferential lane(s) where enter/exit movements are PERMITTED



OR



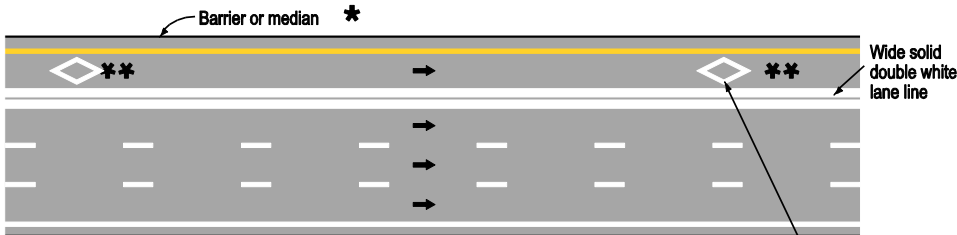
## D – Right-hand side preferential lane(s)



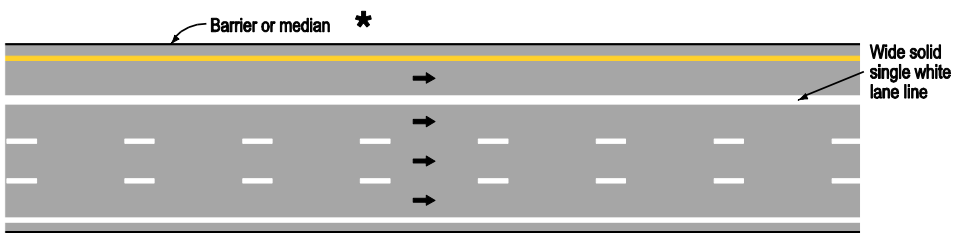
# Figure 3D-3(VA)\*. Markings for Contiguous Preferential Lanes

(This Figure has reverted to Figure 3D-3 from the MUTCD)\*

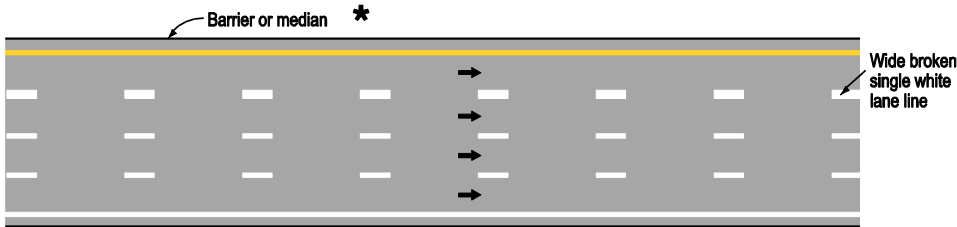
## A – Full-time preferential lane(s) where enter/exit movements are PROHIBITED



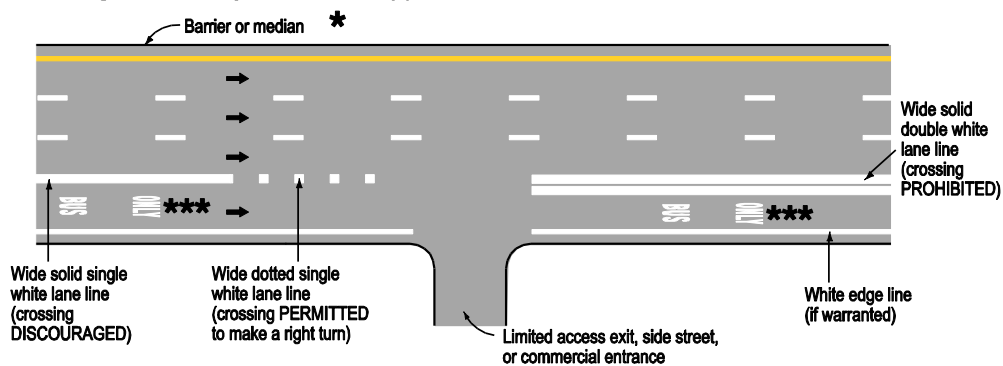
## B – Preferential lane(s) where enter/exit movements are DISCOURAGED



## C – Preferential lane(s) where enter/exit movements are PERMITTED



## D – Right-hand side preferential lane(s)



**Legend**

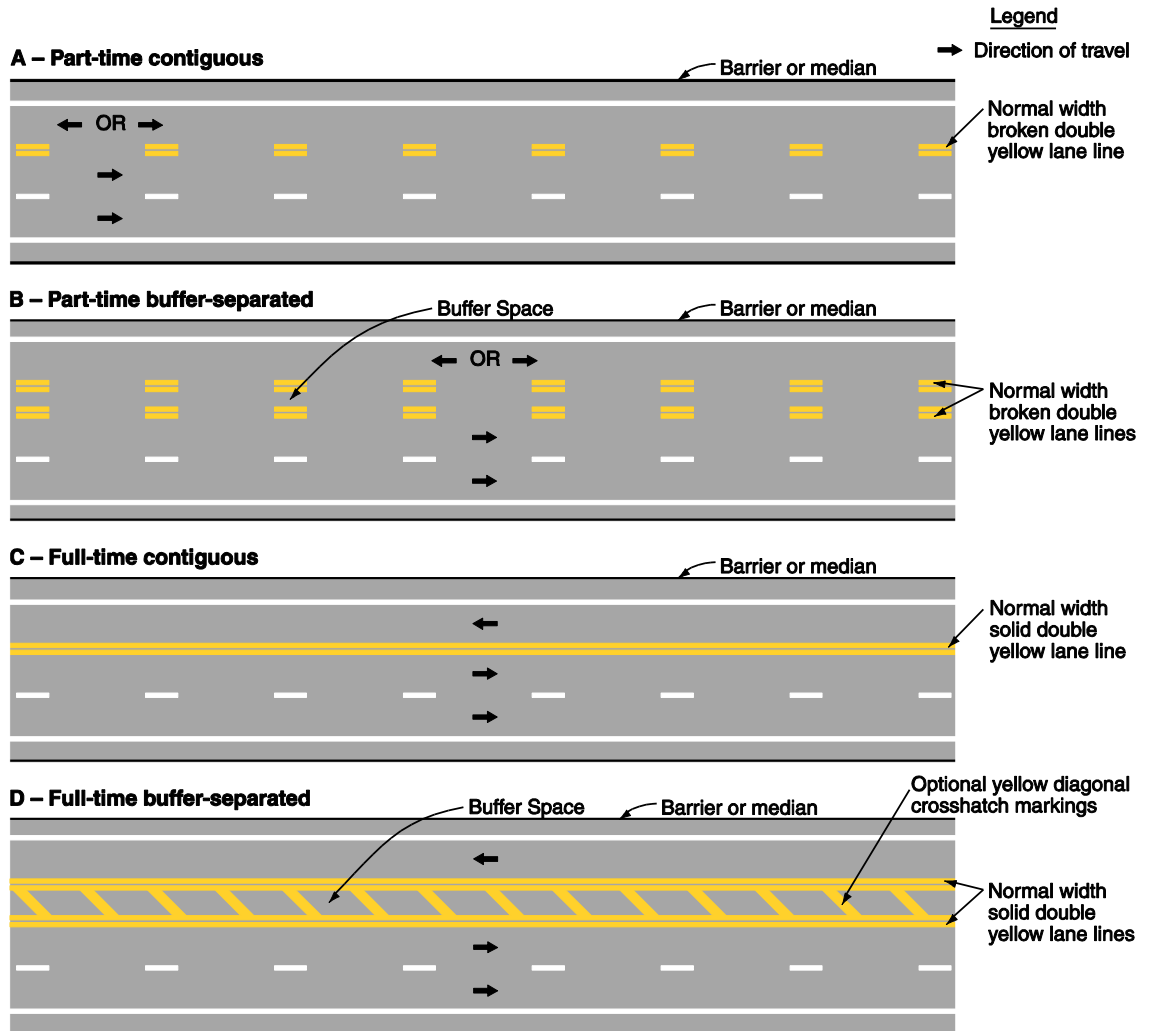
→ Direction of travel

\* If no barrier or median is present and the left-hand side of the lane is the center line of a two-way roadway, use a double yellow center line

\*\* Example of HOV only lane symbol markings

\*\*\* Example of bus lane word markings

### Figure 3D-4. Markings for Counter-Flow Preferential Lanes on Divided Highways



## CHAPTER 3F. DELINEATORS

### Section 3F.02 Delineator Design

**Standard:**

- 01 Delineators shall consist of retroreflective devices that are capable of clearly retroreflecting light under normal atmospheric conditions from a distance of 1,000 feet when illuminated by the high beams of standard automobile lights.



- 02 **Retroreflective elements for delineators shall be Type I or Type II design as described below.**

**Support:**

- 03 Within a series of delineators along a roadway, delineators for a given direction of travel at a specific location are referred to as D-1 delineators if they have one square or circular retroreflective element for that direction. The delineators are referred to as D-2 delineators if they have two identical Type II D-1 retroreflective elements mounted together, or a vertically elongated Type I D-1 delineator such that the vertical dimension is twice that of a Type I D-1 delineator.

### Section 3F.03 Delineator Application

**Standard:**

- 01 The color of delineators shall comply with the color of edge lines stipulated in **Section 3B.06 of this Supplement**.



- 02 A series of **D-1 delineators** shall be provided on the right-hand side of freeways and expressways and on at least one side and on the outside of curve of interchange ramps, except when Condition A, Condition B, or Condition C is met, as follows:

**A. On tangent sections of freeways and expressways when both of the following conditions are met:**

1. Raised pavement markers are used continuously on lane lines throughout all curves and on all tangents to supplement pavement markings, and
2. Roadside delineators are used to lead into all curves.

**B. On sections of roadways where continuous lighting is in operation between interchanges.**

**C. Roadways where delineators are installed on guardrails, parapets, and barriers adjacent to the roadway.**

**Option:**

- 03 Delineators may be provided on other classes of roads. A series of **D-1 delineators** may be provided on the left-hand side of roadways.



**Standard:**

04 **Delineators on the left-hand side of a two-way roadway shall be white (see Figure 3F-1).**

05 **A series of D-1 delineators shall be provided on the outside of curves on interchange ramps.**

06 **Where median crossovers are provided for official or emergency use on divided highways and where these crossovers are to be marked, yellow D-2 delineators shall be placed on the left-hand side of the through roadway on the far side of the crossover for each roadway.**

07 **D-2 delineators shall be installed at 100-foot intervals along acceleration and deceleration lanes.**

08 **Delineators shall be installed on barriers and guardrails that are within 15 feet of the edge of pavement.**

*Guidance:*

09 *A series of delineators should be used wherever guardrail or other longitudinal barriers are present along a roadway or ramp.*

*Option:*

10 Red delineators may be used on the reverse side of any delineator where it would be viewed by a road user traveling in the wrong direction on that particular ramp or roadway.

11 Delineators of the appropriate color may be used to indicate a lane-reduction transition where either an outside or inside lane merges into an adjacent lane.

*Guidance:*

12 *When used for lane-reduction transitions, the delineators should be installed adjacent to the lane or lanes reduced for the full length of the transition and should be so placed and spaced to show the reduction (see Figure 3B-14).*

*Support:*

13 Delineators are not necessary for traffic moving in the direction of a wider pavement or on the side of the roadway where the alignment is not affected by the lane-reduction transition.

*Guidance:*

14 *On a highway with continuous delineation on either or both sides, delineators should be carried through transitions.*

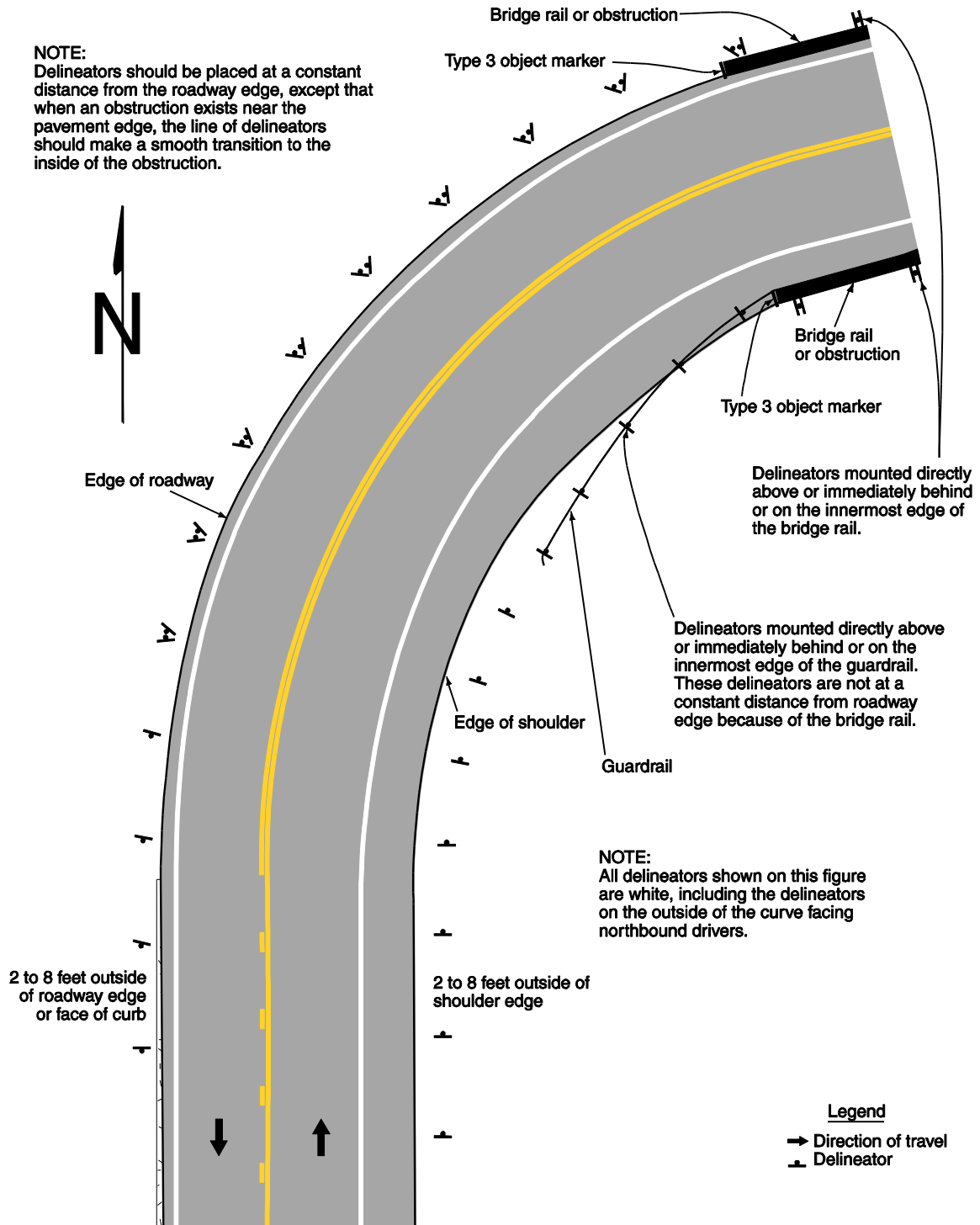
*Option:*

15 On a highway with continuous delineation on either or both sides, the spacing between a series of delineators may be closer.

**Standard:**

16 **When used on a truck escape ramp, delineators shall be red.**

**Figure 3F-1. Examples of Delineator Placement**



*Guidance:*

- 17 *Red delineators should be placed on both sides of truck escape ramps. The delineators should be spaced at 50-foot intervals for a distance sufficient to identify the ramp entrance. Delineator spacing beyond the ramp entrance should be adequate for guidance according to the length and design of the escape ramp.*

**Section 3F.04 Delineator Placement and Spacing***Guidance:*

- 01 *Delineators should be mounted on suitable supports at a mounting height, measured vertically from the bottom of the lowest retroreflective device to the elevation of the near edge of the roadway, of approximately 4 feet.*

*Option:*

- 02 When mounted on the face of or on top of guardrails or other longitudinal barriers, delineators may be mounted at a lower elevation than the normal delineator height recommended in Paragraph 1.

*Guidance:*

- 03 *When used, road edge delineators should be erected two feet beyond the outer edge of the shoulder or the face of un-mountable curb.*
- 04 *Delineators should be placed at a constant distance from the edge of the roadway, except that where an obstruction intrudes into the space between the pavement edge and the extension of the line of the delineators, the delineators should be transitioned to be in line with or inside the innermost edge of the obstruction. If the obstruction is a guardrail or other longitudinal barrier, the delineators should be transitioned to be just behind, directly above (in line with), or on the innermost edge of the guardrail or longitudinal barrier.*

**Standard:**

- 05 **When used, D-1 delineators shall be placed on the right of through roadways at 528 foot spacing. The spacing along interchange ramps shall be at 100 foot intervals except in horizontal curve sections, where the spacing shown in Table 3F-1 shall be used. D-2 delineators shall be placed on acceleration and deceleration lanes at 100 foot spacing.**
- 06 **Spacing for delineators on barrier or guardrail shall be on 80-foot centers unless otherwise indicated. Delineators mounted on guardrail and barriers located in curves on interchange ramps shall be spaced in accordance with the spacing for interstate road-edge delineators as shown in Table 3F-1 except that the maximum spacing shall be 80 feet. Where the center-to-center spacing for delineators on guardrail cannot be obtained due to post spacing, the delineators shall be installed to provide spacing that is not greater than the spacing indicated herein.**

*Support:*

- 07 Examples of delineator installations are shown in Figure 3F-1.

**Option:**

- 08 When uniform spacing is interrupted by such features as driveways and intersections, delineators which would ordinarily be located within the features may be relocated in either direction for a distance not exceeding one quarter of the uniform spacing. Delineators still falling within such features may be eliminated.
- 09 Delineators may be transitioned in advance of a lane transition or obstruction as a guide for oncoming traffic.

**Guidance:**

- 10 *The spacing of delineators should be adjusted on approaches to and throughout horizontal curves so that several delineators are always simultaneously visible to the road user. The approximate spacing shown in Table 3F-1 should be used.*

**Option:**

- 11 When needed for special conditions, delineators of the appropriate color may be mounted in a closely-spaced manner on the face of or on top of guardrails or other longitudinal barriers to form a continuous or nearly continuous "ribbon" of delineation.

**Table 3F-1. Approximate Spacing for Delineators on Horizontal Curves**

Radius (R) of Curve	Approximate Spacing (S) on Curve
50 feet	20 feet
115 feet	25 feet
180 feet	35 feet
250 feet	40 feet
300 feet	50 feet
400 feet	55 feet
500 feet	65 feet
600 feet	70 feet
700 feet	75 feet
800 feet	80 feet
900 feet	85 feet
1,000 feet	90 feet

**Notes:**

- Spacing for specific radii may be interpolated from table.
- The minimum spacing should be 20 feet.
- The spacing on curves should not exceed 300 feet.
- In advance of or beyond a curve, and proceeding away from the end of the curve, the spacing of the first delineator is 2S, the second 3S, and the third 6S, but not to exceed 300 feet.
- S refers to the delineator spacing for specific radii computed from the formula  $S=3\sqrt{R-50}$ .
- The distances for S shown in the table above were rounded to the nearest 5 feet.

## **PART 4. HIGHWAY TRAFFIC SIGNALS**

### **CHAPTER 4A. GENERAL PAGE**

Section 4A.01 Types

Section 4A.02 Definitions Relating to Highway Traffic Signals

### **CHAPTER 4B. TRAFFIC CONTROL SIGNALS—GENERAL PAGE**

Section 4B.01 General

Section 4B.02 Basis of Installation or Removal of Traffic Control Signals

Section 4B.03 Advantages and Disadvantages of Traffic Control Signals

Section 4B.04 Alternatives to Traffic Control Signals

Section 4B.05 Adequate Roadway Capacity

### **CHAPTER 4C. TRAFFIC CONTROL SIGNAL NEEDS STUDIES PAGE**

Section 4C.01 Studies and Factors for Justifying Traffic Control Signals .....4-1

Section 4C.02 Warrant 1, Eight Hour Vehicular Volume.....4-5

Section 4C.03 Warrant 2, Four Hour Vehicular Volume

Section 4C.04 Warrant 3, Peak Hour

Section 4C.05 Warrant 4, Pedestrian Volume

Section 4C.06 Warrant 5, School Crossing

Section 4C.07 Warrant 6, Coordinated Signal System

Section 4C.08 Warrant 7, Crash Experience

Section 4C.09 Warrant 8, Roadway Network

Section 4C.10 Warrant 9, Intersection Near a Grade Crossing

### **CHAPTER 4D. TRAFFIC CONTROL SIGNAL FEATURES PAGE**

Section 4D.01 General

Section 4D.02 Responsibility for Operation and Maintenance

Section 4D.03 Provisions for Pedestrians ..... 4-11

Section 4D.04 Meaning of Vehicular Signal Indications ..... 4-11

Section 4D.05 Application of Steady Signal Indications ..... 4-16

Section 4D.06 Signal Indications – Design, Illumination, Color, and Shape

Section 4D.07 Size of Vehicular Signal Indications

Section 4D.08 Positions of Signal Indications Within a Signal Face – General

Section 4D.09 Positions of Signal Indications Within a Vertical Signal Face

Section 4D.10 Positions of Signal Indications Within a Horizontal Signal Face

Section 4D.11 Number of Signal Faces on an Approach

Section 4D.12 Visibility, Aiming, and Shielding of Signal Faces .....	4-22
Section 4D.13 Lateral Positioning of Signal Faces	
Section 4D.14 Longitudinal Positioning of Signal Faces	
Section 4D.15 Mounting Height of Signal Faces	
Section 4D.16 Lateral Offset (Clearance) of Signal Faces	
Section 4D.17 Signal Indications for Left Turn Movements – General	
Section 4D.18 Signal Indications for Permissive Only Mode Left Turn Movements .....	4-25
Section 4D.19 Signal Indications for Protected Only Mode Left Turn Movements .....	4-28
Section 4D.20 Signal Indications for Protected/Permissive Mode Left Turn Movements	
Section 4D.21 Signal Indications for Right Turn Movements – General	
Section 4D.22 Signal Indications for Permissive Only Mode Right Turn Movements	
Section 4D.23 Signal Indications for Protected Only Mode Right Turn Movements .....	4-32
Section 4D.24 Signal Indications for Protected/Permissive Mode Right Turn Movements	
Section 4D.25 Signal Indications for Approaches With Shared Left Turn/Right Turn Lanes and No Through Movement	
Section 4D.26 Yellow Change and Red Clearance Intervals .....	4-36
Section 4D.27 Preemption and Priority Control of Traffic Control Signals	
Section 4D.28 Flashing Operation of Traffic Control Signals – General .....	4-38
Section 4D.29 Flashing Operation – Transition Into Flashing Mode	
Section 4D.30 Flashing Operation – Signal Indications During Flashing Mode	
Section 4D.31 Flashing Operation – Transition Out of Flashing Mode	
Section 4D.32 Temporary and Portable Traffic Control Signals	
Section 4D.33 Lateral Offset of Signal Supports and Cabinets	
Section 4D.34 Use of Signs at Signalized Locations	
Section 4D.35 Use of Pavement Markings at Signalized Locations	
<b>Section 4D.V1 Traffic Control Signal Housing Color .....</b>	<b>4-40</b>



<b>CHAPTER 4E. PEDESTRIAN CONTROL FEATURES</b>	<b>PAGE</b>
--	-------------

Section 4E.01 Pedestrian Signal Heads	
Section 4E.02 Meaning of Pedestrian Signal Head Indications	
Section 4E.03 Application of Pedestrian Signal Heads	
Section 4E.04 Size, Design, and Illumination of Pedestrian Signal Head Indications	
Section 4E.05 Location and Height of Pedestrian Signal Heads	
Section 4E.06 Pedestrian Intervals and Signal Phases	
Section 4E.07 Countdown Pedestrian Signals	
Section 4E.08 Pedestrian Detectors	
Section 4E.09 Accessible Pedestrian Signals and Detectors – General .....	4-41
Section 4E.10 Accessible Pedestrian Signals and Detectors – Location	

Section 4E.11 Accessible Pedestrian Signals and Detectors – Walk Indications .....	4-43
Section 4E.12 Accessible Pedestrian Signals and Detectors – Tactile Arrows and Locator Tones .....	4-46
Section 4E.13 Accessible Pedestrian Signals and Detectors – Extended Pushbutton Press Features	

<b>CHAPTER 4F. PEDESTRIAN HYBRID BEACONS</b>	<b>PAGE</b>
--	-------------

Section 4F.01 Application of Pedestrian Hybrid Beacons	
Section 4F.02 Design of Pedestrian Hybrid Beacons	
Section 4F.03 Operation of Pedestrian Hybrid Beacons	

<b>CHAPTER 4G. TRAFFIC CONTROL SIGNALS AND HYBRID BEACONS FOR EMERGENCY-VEHICLE ACCESS</b>	<b>PAGE</b>
--	-------------

Section 4G.01 Application of Emergency Vehicle Traffic Control Signals and Hybrid Beacons	
Section 4G.02 Design of Emergency Vehicle Traffic Control Signals	
Section 4G.03 Operation of Emergency Vehicle Traffic Control Signals	
Section 4G.04 Emergency Vehicle Hybrid Beacons	

<b>CHAPTER 4H. TRAFFIC CONTROL SIGNALS FOR ONE-LANE, TWO-WAY FACILITIES</b>	<b>PAGE</b>
---	-------------

Section 4H.01 Application of Traffic Control Signals for One Lane, Two Way Facilities	
Section 4H.02 Design of Traffic Control Signals for One Lane, Two Way Facilities	
Section 4H.03 Operation of Traffic Control Signals for One Lane, Two Way Facilities	

<b>CHAPTER 4I. TRAFFIC CONTROL SIGNALS FOR FREEWAY ENTRANCE RAMPS</b>	<b>PAGE</b>
---	-------------

Section 4I.01 Application of Freeway Entrance Ramp Control Signals	
Section 4I.02 Design of Freeway Entrance Ramp Control Signals	
Section 4I.03 Operation of Freeway Entrance Ramp Control Signals	

<b>CHAPTER 4J. TRAFFIC CONTROL FOR MOVABLE BRIDGES</b>	<b>PAGE</b>
--	-------------

Section 4J.01 Application of Traffic Control for Movable Bridges	
Section 4J.02 Design and Location of Movable Bridge Signals and Gates .....	4-48
Section 4J.03 Operation of Movable Bridge Signals and Gates	

<b>CHAPTER 4K. HIGHWAY TRAFFIC SIGNALS AT TOLL PLAZAS</b>	<b>PAGE</b>
---	-------------

Section 4K.01 Traffic Signals at Toll Plazas	
Section 4K.02 Lane Use Control Signals at or Near Toll Plazas	
Section 4K.03 Warning Beacons at Toll Plazas	

**CHAPTER 4L. FLASHING BEACONS** **PAGE**

---

- Section 4L.01 General Design and Operation of Flashing Beacons
- Section 4L.02 Intersection Control Beacon
- Section 4L.03 Warning Beacon
- Section 4L.04 Speed Limit Sign Beacon
- Section 4L.05 Stop Beacon

**CHAPTER 4M. LANE-USE CONTROL SIGNALS** **PAGE**

---

- Section 4M.01 Application of Lane Use Control Signals
- Section 4M.02 Meaning of Lane Use Control Signal Indications
- Section 4M.03 Design of Lane Use Control Signals
- Section 4M.04 Operation of Lane Use Control Signals

**CHAPTER 4N. IN-ROADWAY LIGHTS** **PAGE**

---

- Section 4N.01 Application of In Roadway Lights ..... 4-52
- Section 4N.02 In Roadway Warning Lights at Crosswalks ..... 4-52



# PART 4

## HIGHWAY TRAFFIC SIGNALS

### CHAPTER 4C. TRAFFIC CONTROL SIGNAL NEEDS STUDIES

#### Section 4C.01 Studies and Factors for Justifying Traffic Control Signals

##### Standard:

- 01 An engineering study of traffic conditions, pedestrian characteristics, and physical characteristics of the location shall be performed to determine whether installation of a traffic control signal is justified at a particular location.
- 02 The investigation of the need for a traffic control signal shall include an analysis of factors related to the existing operation and safety at the study location and the potential to improve these conditions, and the applicable factors contained in the following traffic signal warrants:
  - Warrant 1, Eight-Hour Vehicular Volume
  - Warrant 2, Four-Hour Vehicular Volume
  - Warrant 3, Peak Hour
  - Warrant 4, Pedestrian Volume
  - Warrant 5, School Crossing
  - Warrant 6, Coordinated Signal System
  - Warrant 7, Crash Experience
  - Warrant 8, Roadway Network
  - Warrant 9, Intersection Near a Grade Crossing
- 03 The satisfaction of a traffic signal warrant or warrants shall not in itself require the installation of a traffic control signal.
- 04 In order for a traffic signal to be justified, evidence of the need for right of way assignment beyond that which could be provided by a stop sign shall be demonstrated. Examples of such a need include: excessive delay, congestion, unfavorable approach conditions, or surrounding conditions that cause driver confusion.
- 05 On any roadway corridor designated by the CTB as a Corridor of Statewide Significance, intersections or new access points which meet warrants for traffic signals shall not have a new traffic signal installed until alternatives such as grade separations, parallel service roads, roundabouts, and other possible options have



**been evaluated and determined not to be appropriate for the location. Appendix A of this Supplement contains a link to information about Corridors of Statewide Significance.\***

*Guidance:*

- 06 *Land use planning should also be considered in identifying alternatives to traffic signals along Corridors of Statewide Significance. This could include, but is not limited to, promotion of nodal development patterns in order to minimize strip development and to make the best use of investments in access points.*

*Support:*

- 07 The following laws, regulations, and VDOT standards support the above policy statement:
- A. The Code of Virginia § 15.2-2222.1: Coordination of state and local transportation planning.
  - B. The Code of Virginia § 15.2-2223: Comprehensive plan to be prepared and adopted and shall include a scope and purpose.
  - C. The Code of Virginia § 15.2-2223.1: Comprehensive plan to be prepared and adopted and shall include urban development areas.
  - D. The Code of Virginia § 33.1-198: Connections over shoulders of highways for intersecting commercial establishment entrances.
  - E. The Code of Virginia § 33.1-198.1: Comprehensive highway access management standards.
  - F. The Code of Virginia § 33.1-199: Replacing entrances destroyed by Commissioner.
  - G. House Joint Resolution 594 of 2003: Encouraging the Department of Transportation to construct more roundabouts instead of signalized intersections.
  - H. 24 VAC 30-72 Access Management Regulations: Principal Arterials
    1. Section 60: VDOT is not obligated to permit the most convenient access, VDOT may require the applicant to alter the location or design to obtain the best operational characteristics, and any locality standards stricter than VDOT's shall govern.
    2. Section 70: Sites accessed shall be designed to prevent unsafe and inefficient traffic movements from impacting travel on highway. If a proposed entrance will cause a degradation in safety or capacity or an increase in delay, applicant shall submit and fund plan to mitigate impacts, including:
      - Constructing turn lanes,
      - Removing or relocating crossovers,
      - Modification or removal of traffic signals, or
      - Implementing recommendations from adopted corridor studies.
    3. Section 120: Entrances must be designed in accordance with Appendix F of the Road Design Manual. VDOT will determine the improvements needed to preserve the highway. Spacing of entrances and intersections shall comply with spacing standards in Appendix F (exceptions to the standards set out). Traffic

signals are not allowed for entrances if the spacing is below standards. An exception process for the above items is outlined.

- I. 24 VAC 30-155 Traffic Impact Analysis Regulations (Chapter 527)
    - 1. Section 60: Recommendations for improvements contained in a study shall be in accordance with standards contained in the Road Design Manual.
  - J. Appendix F of Road Design Manual
    - 1. Section 2: Intersection design and intersection, crossover, and entrance spacing standards. Roundabouts are to be considered when constructing or reconstructing a signalized or an unsignalized intersection. Roundabouts are the preferred alternative if a study shows that they are feasible.
    - 2. Section 3: Turn lane design and warrants, and median crossover design, including directional median openings.
- 08 Sections 8C.09 and 8C.10 of the MUTCD contain information regarding the use of traffic control signals instead of gates and/or flashing-light signals at highway-rail grade crossings and highway-light rail transit grade crossings, respectively.
- Guidance:*
- 09 *A traffic control signal should not be installed unless one or more of the factors described in this Chapter are met.*
- 10 *A traffic control signal should not be installed unless an engineering study indicates that installing a traffic control signal will improve the overall safety and/or operation of the intersection.*
- 11 *A traffic control signal should not be installed if it will seriously disrupt progressive traffic flow.*
- 12 *The study should consider the effects of the right-turn vehicles from the minor-street approaches. Engineering judgment should be used to determine what, if any, portion of the right-turn traffic is subtracted from the minor-street traffic count when evaluating the count against the signal warrants listed in Paragraph 2.*
- 13 *Engineering judgment should also be used in applying various traffic signal warrants to cases where approaches consist of one lane plus one left-turn or right-turn lane. The site-specific traffic characteristics should dictate whether an approach is considered as one lane or two lanes. For example, for an approach with one lane for through and right-turning traffic plus a left-turn lane, if engineering judgment indicates that it should be considered a one-lane approach because the traffic using the left-turn lane is minor, the total traffic volume approaching the intersection should be applied against the signal warrants as a one-lane approach. The approach should be considered two lanes if approximately half of the traffic on the approach turns left and the left-turn lane is of sufficient length to accommodate all left-turn vehicles.*
- 14 *Similar engineering judgment and rationale should be applied to a street approach with one through/left-turn lane plus a right-turn lane. In this case, the degree of conflict of minor-street right-turn traffic with traffic on the major street should be considered. Thus, right-turn traffic should not be included in the minor-street volume if the movement*

- enters the major street with minimal conflict. The approach should be evaluated as a one-lane approach with only the traffic volume in the through/left-turn lane considered.*
- 15 *At a location that is under development or construction and where it is not possible to obtain a traffic count that would represent future traffic conditions, hourly volumes should be estimated as part of an engineering study for comparison with traffic signal warrants. Except for locations where the engineering study uses the satisfaction of Warrant 8 to justify a signal, a traffic control signal installed under projected conditions should have an engineering study done within 1 year of putting the signal into stop-and-go operation to determine if the signal is justified. If not justified, the signal should be taken out of stop-and-go operation or removed.*
- 16 *For signal warrant analysis, a location with a wide median, even if the median width is greater than 30 feet, should be considered as one intersection.*

Option:

- 17 At an intersection with a high volume of left-turn traffic from the major street, the signal warrant analysis may be performed in a manner that considers the higher of the major-street left-turn volumes as the "minor-street" volume and the corresponding single direction of opposing traffic on the major street as the "major-street" volume.
- 18 For signal warrants requiring conditions to be present for a certain number of hours in order to be satisfied, any four sequential 15-minute periods may be considered as 1 hour if the separate 1-hour periods used in the warrant analysis do not overlap each other and both the major-street volume and the minor-street volume are for the same specific one-hour periods.
- 19 For signal warrant analysis, bicyclists may be counted as either vehicles or pedestrians.

Support:

- 20 When performing a signal warrant analysis, bicyclists riding in the street with other vehicular traffic are usually counted as vehicles and bicyclists who are clearly using pedestrian facilities are usually counted as pedestrians.

Option:

- 21 Engineering study data may include the following:
- A. The number of vehicles entering the intersection in each hour from each approach during 12 hours of an average day. It is desirable that the hours selected contain the greatest percentage of the 24-hour traffic volume.
  - B. Vehicular volumes for each traffic movement from each approach, classified by vehicle type (heavy trucks, passenger cars and light trucks, public-transit vehicles, and, in some locations, bicycles), during each 15-minute period of the 2 hours in the morning and 2 hours in the afternoon during which total traffic entering the intersection is greatest.
  - C. Pedestrian volume counts on each crosswalk during the same periods as the vehicular counts in Item B and during hours of highest pedestrian volume. Where young, elderly, and/or persons with physical or visual disabilities need special consideration, the pedestrians and their crossing times may be classified by general observation.



- D. Information about nearby facilities and activity centers that serve the young, elderly, and/or persons with disabilities, **such as elementary schools, playgrounds, hospitals, or nursing homes**. This includes requests from persons with disabilities for accessible crossing improvements at the location under study. These persons might not be adequately reflected in the pedestrian volume count if the absence of a signal restrains their mobility.
  - E. The posted or statutory speed limit or the 85th-percentile speed on the uncontrolled approaches to the location.
  - F. A condition diagram showing details of the physical layout, including such features as intersection geometrics, channelization, grades, sight-distance restrictions, transit stops and routes, parking conditions, pavement markings, roadway lighting, driveways, nearby railroad crossings, distance to nearest traffic control signals, utility poles and fixtures, and adjacent land use.
  - G. A collision diagram showing crash experience by type, location, direction of movement, severity, weather, time of day, date, and day of week for at least 1 year.
- 22 The following data, which are desirable for a more precise understanding of the operation of the intersection, may be obtained during the periods described in Item B of Paragraph 21:
- A. Vehicle-hours of stopped time delay determined separately for each approach.
  - B. The number and distribution of acceptable gaps in vehicular traffic on the major street for entrance from the minor street.
  - C. The posted or statutory speed limit or the 85th-percentile speed on controlled approaches at a point near to the intersection but unaffected by the control.
  - D. Pedestrian delay time for at least two 30-minute peak pedestrian delay periods of an average weekday or like periods of a Saturday or Sunday.
  - E. Queue length on stop-controlled approaches.

## **Section 4C.02 Warrant 1, Eight-Hour Vehicular Volume**

### Support:

- 01 The Minimum Vehicular Volume, Condition A, is intended for application at locations where a large volume of intersecting traffic is the principal reason to consider installing a traffic control signal.
- 02 The Interruption of Continuous Traffic, Condition B, is intended for application at locations where Condition A is not satisfied and where the traffic volume on a major street is so heavy that traffic on a minor intersecting street suffers excessive delay or conflict in entering or crossing the major street.
- 03 It is intended that Warrant 1 be treated as a single warrant. If Condition A is satisfied, then Warrant 1 is satisfied and analyses of Condition B and the combination of Conditions A and B are not needed. Similarly, if Condition B is satisfied, then Warrant 1 is satisfied and an analysis of the combination of Conditions A and B is not needed.

**Standard:**

- 04 **The need for a traffic control signal shall be considered if an engineering study finds that one of the following conditions exist for each of any 8 hours of an average day:**
- A. The vehicles per hour given in both of the 100 percent columns of Condition A in Table 4C-1 exist on the major-street and the higher-volume minor-street approaches, respectively, to the intersection; or**
  - B. The vehicles per hour given in both of the 100 percent columns of Condition B in Table 4C-1 exist on the major-street and the higher-volume minor-street approaches, respectively, to the intersection.**

**In applying each condition the major-street and minor-street volumes shall be for the same 8 hours. On the minor street, the higher volume shall not be required to be on the same approach during each of these 8 hours.**

## Option:

- 05 If the posted or statutory speed limit or the 85th-percentile speed on the major street exceeds 40 mph, or if the intersection lies within the built-up area of an isolated community having a population of less than 10,000, the traffic volumes in the 70 percent columns in Table 4C-1 may be used in place of the 100 percent columns.

*Guidance:*

- 06 *The combination of Conditions A and B is intended for application at locations where Condition A is not satisfied and Condition B is not satisfied and should be applied only after an adequate trial of other alternatives that could cause less delay and inconvenience to traffic has failed to solve the traffic problems.*

**Standard:**

- 07 **The need for a traffic control signal shall be considered if an engineering study finds that both of the following conditions exist for each of any 8 hours of an average day:**
- A. The vehicles per hour given in both of the 80 percent columns of Condition A in Table 4C-1 exist on the major-street and the higher-volume minor-street approaches, respectively, to the intersection; and**
  - B. The vehicles per hour given in both of the 80 percent columns of Condition B in Table 4C-1 exist on the major-street and the higher-volume minor-street approaches, respectively, to the intersection.**

**These major-street and minor-street volumes shall be for the same 8 hours for each condition; however, the 8 hours satisfied in Condition A shall not be required to be the same 8 hours satisfied in Condition B. On the minor street, the higher volume shall not be required to be on the same approach during each of the 8 hours.**

## Option:

- 08 If the posted or statutory speed limit or the 85th-percentile speed on the major street exceeds 40 mph, or if the intersection lies within the built-up area of an isolated community having a population of less than 10,000, the traffic volumes in the 56 percent columns in Table 4C-1 may be used in place of the 80 percent columns.

## Table 4C-1. Warrant 1, Eight-Hour Vehicle Volume

### Condition A—Minimum Vehicular Volume

Number of lanes for moving traffic on each approach		Vehicles per hour on major street (total of both approaches)				Vehicles per hour on higher-volume minor-street approach (one direction only)			
Major Street	Minor Street	100% <sup>a</sup>	80% <sup>b</sup>	70% <sup>c</sup>	56% <sup>d</sup>	100% <sup>a</sup>	80% <sup>b</sup>	70% <sup>c</sup>	56% <sup>d</sup>
1	1	500	400	350	280	150	120	105	84
2 or more	1	600	480	420	336	150	120	105	84
2 or more	2 or more	600	480	420	336	200	160	140	112
1	2 or more	500	400	350	280	200	160	140	112

### Condition B—Interruption of Continuous Traffic

Number of lanes for moving traffic on each approach		Vehicles per hour on major street (total of both approaches)				Vehicles per hour on higher-volume minor-street approach (one direction only)			
Major Street	Minor Street	100% <sup>a</sup>	80% <sup>b</sup>	70% <sup>c</sup>	56% <sup>d</sup>	100% <sup>a</sup>	80% <sup>b</sup>	70% <sup>c</sup>	56% <sup>d</sup>
1	1	750	600	525	420	75	60	53	42
2 or more	1	900	720	630	504	75	60	53	42
2 or more	2 or more	900	720	630	504	100	80	70	56
1	2 or more	750	600	525	420	100	80	70	56

<sup>a</sup> Basic minimum hourly volume

<sup>b</sup> Used for combination of Conditions A and B after adequate trial of other remedial measures

<sup>c</sup> May be used when the major-street speed exceeds 40 mph or in an isolated community with a population of less than 10,000

<sup>d</sup> May be used for combination of Conditions A and B after adequate trial of other remedial measures when the major-street speed exceeds

40 mph or in an isolated community with a population of less than 10,000



- 09 If it is not reasonable or feasible to count actual traffic volumes, such as at a proposed intersection in the preliminary engineering phase and therefore not yet open to traffic, ADT projections may be utilized to satisfy Warrant 1. The ADT values are shown in Table 4C-V1.

#### Standard:

- 10 If used, ADT projections shall be developed utilizing the latest edition of ITE's Trip Generation Manual.



## Table 4C-V1. Traffic Signal Warrant Using Average Daily Traffic Estimate

(To be used only when traffic counts are not available, such as at a future intersection)

### Condition A—Minimum Vehicular Volume

Number of lanes for moving traffic on each approach		Vehicles per day on major street (total of both approaches)				Vehicles per day on higher-volume minor-street approach (one direction only)			
Major Street	Minor Street	100% <sup>a</sup>	80% <sup>b</sup>	70% <sup>c</sup>	56% <sup>d</sup>	100% <sup>a</sup>	80% <sup>b</sup>	70% <sup>c</sup>	56% <sup>d</sup>
1	1	8,000	6,400	5,600	4,480	2,400	1,920	1,680	1,344
2 or more	1	9,600	7,680	6,720	5,376	2,400	1,920	1,680	1,344
2 or more	2 or more	9,600	7,680	6,720	5,376	3,200	2,560	2,240	1,792
1	2 or more	8,000	6,400	5,600	4,480	3,200	2,560	2,240	1,792

### Condition B—Interruption of Continuous Traffic

Number of lanes for moving traffic on each approach		Vehicles per day on major street (total of both approaches)				Vehicles per day on higher-volume minor-street approach (one direction only)			
Major Street	Minor Street	100% <sup>a</sup>	80% <sup>b</sup>	70% <sup>c</sup>	56% <sup>d</sup>	100% <sup>a</sup>	80% <sup>b</sup>	70% <sup>c</sup>	56% <sup>d</sup>
1	1	12,000	9,600	8,400	6,720	1,200	960	850	680
2 or more	1	14,400	11,520	10,080	8,064	1,200	960	850	680
2 or more	2 or more	14,400	11,520	10,080	8,064	1,600	1,280	1,120	896
1	2 or more	12,000	9,600	8,400	6,720	1,600	1,280	1,120	896

<sup>a</sup> Basic minimum hourly volume for urban areas

<sup>b</sup> Used for combination of Conditions A and B after adequate consideration of other remedial measures in urban areas

<sup>c</sup> May be used when the major-street speed exceeds 40 mph or in an isolated community with a population of less than 10,000

<sup>d</sup> May be used for combination of Conditions A and B after adequate consideration of other remedial measures when the major-street speed exceeds 40 mph or in an isolated community with a population of less than 10,000



- 11 **The need for a traffic control signal shall be considered using ADT projections if an engineering study finds that one of the following conditions exist for an average day:**
- A. The vehicles per day given in both of the 100 percent columns of Condition A in Table 4C-V1 exist on the major-street and the higher-volume minor-street approaches, respectively, to the intersection; or**
  - B. The vehicles per day given in both of the 100 percent columns of Condition B in Table 4C-V1 exist on the major-street and the higher-volume minor-street approaches, respectively, to the intersection.**

Option:

- 12 If the posted or statutory speed limit or the 85th-percentile speed on the major street exceeds 40 mph, or if the intersection lies within the built-up area of an isolated community having a population of less than 10,000, the traffic volumes in the 70 percent columns in Table 4C-V1 in this Supplement may be used in place of the 100 percent columns.

*Guidance:*

- 13 *The combination of Conditions A and B is intended for application at locations where Condition A is not satisfied and Condition B is not satisfied and should be applied only after an adequate trial of other alternatives that could cause less delay and inconvenience to traffic has failed to solve the traffic problems.*

**Standard:**

- 14 **The need for a traffic control signal shall be considered using ADT projections if an engineering study finds that both of the following conditions exist for an average day:**
- A. The vehicles per day given in both of the 80 percent columns of Condition A in Table 4C-V1 exist on the major-street and the higher-volume minor-street approaches, respectively, to the intersection; and**
  - B. The vehicles per day given in both of the 80 percent columns of Condition B in Table 4C-V1 exist on the major-street and the higher-volume minor-street approaches, respectively, to the intersection.**

Option:

- 15 If the posted or statutory speed limit or the 85th-percentile speed on the major street exceeds 40 mph, or if the intersection lies within the built-up area of an isolated community having a population of less than 10,000, the traffic volumes in the 56 percent columns in Table 4C-V1 in this Supplement may be used in place of the 80 percent columns.

**Standard:**

- 16 **Warrant 1, Eight-Hour Vehicular Volume, is included in this Supplement. The other warrants in the MUTCD that are not contained in this Supplement are still in effect. In addition to Warrant 1, the investigation of the need for a traffic control signal shall include an analysis of factors related to the existing operation and safety at the study location, and the applicable factors contained in the other eight traffic signal warrants in the MUTCD:**

- **Warrant 2, Four-Hour Vehicular Volume**
- **Warrant 3, Peak Hour**
- **Warrant 4, Pedestrian Volume**
- **Warrant 5, School Crossing**
- **Warrant 6, Coordinated Signal System**
- **Warrant 7, Crash Experience**
- **Warrant 8, Roadway Network**
- **Warrant 9, Intersection Near a Grade Crossing**

# CHAPTER 4D. TRAFFIC CONTROL SIGNAL FEATURES

## Section 4D.03 Provisions for Pedestrians

Support:

- 01 Chapter 4E contains additional information regarding pedestrian signals and Chapter 4F contains additional information regarding pedestrian hybrid beacons.

**Standard:**

- 02 **The design and operation of traffic control signals shall take into consideration the needs of pedestrian as well as vehicular traffic.**
- 03 **If engineering judgment indicates the need for provisions for a given pedestrian movement, signal faces conveniently visible to pedestrians shall be provided by pedestrian signal heads (see Chapter 4E) or a vehicular signal face(s) for a concurrent vehicular movement.**

*Guidance:*

- 04 *Accessible pedestrian signals (see Sections 4E.09, 4E.11 and Section 4E.12 of this Supplement and Sections 4E.10 and 4E.13 of the MUTCD) that provide information in non-visual formats (such as audible tones, speech messages, and/or vibrating surfaces) should be provided where determined appropriate by engineering judgment.*

Support:



- 05 For more information regarding the evaluation of locations for accessible pedestrian signals, refer to the Virginia Center for Transportation Innovation and Research report, "Guidelines for the Retrofit Installation of Accessible Pedestrian Signals by the Virginia Department of Transportation."
- 06 Where pedestrian movements regularly occur, pedestrians should be provided with sufficient time to cross the roadway by adjusting the traffic control signal operation and timing to provide sufficient crossing time every cycle or by providing pedestrian detectors.
- 07 If it is necessary or desirable to prohibit certain pedestrian movements at a traffic control signal location, No Pedestrian Crossing (R9-3) signs (see Section 2B.51 of the MUTCD) should be used if it is not practical to provide a barrier or other physical feature to physically prevent the pedestrian movements.

## Section 4D.04 Meaning of Vehicular Signal Indications

Support:

- 01 The "Uniform Vehicle Code" (see Section 1A.11 of this Supplement) is the primary source for the standards for the meaning of vehicular signal indications to both vehicle

operators and pedestrians as provided in this Section, and the standards for the meaning of separate pedestrian signal head indications as provided in [Section 4E.02 of the MUTCD](#).

- 02 The physical area that is defined as being "within the intersection" is dependent upon the conditions that are described in the definition of intersection in [Section 1A.13 of this Supplement](#).

**Standard:**

- 03 **The following meanings shall be given to highway traffic signal indications for vehicles and pedestrians:**

**A. Steady green signal indications shall have the following meanings:**

1. **Vehicular traffic facing a CIRCULAR GREEN signal indication is permitted to proceed straight through or turn right or left or make a U-turn movement except as such movement is modified by lane-use signs, turn prohibition signs, lane markings, roadway design, separate turn signal indications, or other traffic control devices.**

**Such vehicular traffic, including vehicles turning right or left or making a U-turn movement, shall yield the right-of-way to:**

- a. **Pedestrians lawfully within an associated crosswalk, and**
- b. **Other vehicles lawfully within the intersection.**

**In addition, vehicular traffic turning left or making a U-turn movement to the left shall yield the right-of-way to other vehicles approaching from the opposite direction so closely as to constitute an immediate hazard during the time when such turning vehicle is moving across or within the intersection.**

2. **Vehicular traffic facing a GREEN ARROW signal indication, displayed alone or in combination with another signal indication, is permitted to cautiously enter the intersection only to make the movement indicated by such arrow, or such other movement as is permitted by other signal indications displayed at the same time.**

**Such vehicular traffic, including vehicles turning right or left or making a U-turn movement, shall yield the right-of-way to:**

- a. **Pedestrians lawfully within an associated crosswalk, and**
- b. **Other vehicles lawfully within the intersection.**

3. **Pedestrians facing a CIRCULAR GREEN signal indication, unless otherwise directed by a pedestrian signal indication or other traffic control device, are permitted to proceed across the roadway within any marked or unmarked associated crosswalk. The pedestrian shall yield the right-of-way to vehicles lawfully within the intersection or so close as to create an immediate hazard at the time that the green signal indication is first displayed.**

4. Pedestrians facing a GREEN ARROW signal indication, unless otherwise directed by a pedestrian signal indication or other traffic control device, shall not cross the roadway.

B. Steady yellow signal indications shall have the following meanings:

1. Vehicular traffic facing a steady CIRCULAR YELLOW signal indication is thereby warned that the related green movement or the related flashing arrow movement is being terminated or that a steady red signal indication will be displayed immediately thereafter when vehicular traffic shall not enter the intersection. The rules set forth concerning vehicular operation under the movement(s) being terminated shall continue to apply while the steady CIRCULAR YELLOW signal indication is displayed.
2. Vehicular traffic facing a steady YELLOW ARROW signal indication is thereby warned that the related GREEN ARROW movement or the related flashing arrow movement is being terminated. The rules set forth concerning vehicular operation under the movement(s) being terminated shall continue to apply while the steady YELLOW ARROW signal indication is displayed.
3. Pedestrians facing a steady CIRCULAR YELLOW or YELLOW ARROW signal indication, unless otherwise directed by a pedestrian signal indication or other traffic control device shall not start to cross the roadway.

C. Steady red signal indications shall have the following meanings:

1. Vehicular traffic facing a steady CIRCULAR RED ~~or steady right turn RED~~ **ARROW\*** signal indication, unless entering the intersection to make another movement permitted by another signal indication, shall stop at a clearly marked stop line; but if there is no stop line, traffic shall stop before entering the crosswalk on the near side of the intersection; or if there is no crosswalk, then before entering the intersection; and shall remain stopped until a signal indication to proceed is displayed, or as provided below.  
 Except when a traffic control device is in place prohibiting a turn on red or a steady ~~left turn\*~~ RED ARROW signal indication is displayed, vehicular traffic facing a steady CIRCULAR RED signal indication is permitted to enter the intersection to turn right, or to turn left from a one-way street into a one-way street, after stopping. The right to proceed with the turn shall be subject to the rules applicable after making a stop at a STOP sign.
2. Vehicular traffic facing a steady ~~left turn\*~~ RED ARROW signal indication shall not enter the intersection to make the movement indicated by the arrow and, unless entering the intersection to make another movement permitted by another signal indication, shall stop at a clearly marked stop line; but if there is no stop line, before entering the crosswalk on the near side of the intersection; or if there is no crosswalk, then before entering the intersection; and shall remain stopped until a signal indication or other traffic control device permitting the movement indicated by such ~~left turn\*~~ RED ARROW is displayed.



When a traffic control device is in place permitting a turn on a steady ~~left-turn~~\* RED ARROW signal indication, vehicular traffic facing a steady ~~left-turn~~\* RED ARROW signal indication is permitted to enter the intersection to make the movement indicated by the arrow signal indication, after stopping. The right to proceed with the turn shall be limited to the direction indicated by the arrow and shall be subject to the rules applicable after making a stop at a STOP sign.

3. Unless otherwise directed by a pedestrian signal indication or other traffic control device, pedestrians facing a steady CIRCULAR RED or steady RED ARROW signal indication shall not enter the roadway.
- D. A flashing green signal indication has no meaning and shall not be used.
- E. Flashing yellow signal indications shall have the following meanings:

1. Vehicular traffic, on an approach to an intersection, facing a flashing CIRCULAR YELLOW signal indication is permitted to cautiously enter the intersection to proceed straight through or turn right or left or make a U-turn except as such movement is modified by lane-use signs, turn prohibition signs, lane markings, roadway design, separate turn signal indications, or other traffic control devices.

Such vehicular traffic, including vehicles turning right or left or making a U-turn, shall yield the right-of-way to:

- a. Pedestrians lawfully within an associated crosswalk, and
- b. Other vehicles lawfully within the intersection.

In addition, vehicular traffic turning left or making a U-turn to the left shall yield the right-of-way to other vehicles approaching from the opposite direction so closely as to constitute an immediate hazard during the time when such turning vehicle is moving across or within the intersection.

2. Vehicular traffic, on an approach to an intersection, facing a flashing YELLOW ARROW signal indication, displayed alone or in combination with another signal indication, is permitted to cautiously enter the intersection only to make the movement indicated by such arrow, or other such movement as is permitted by other signal indications displayed at the same time.

Such vehicular traffic, including vehicles turning right or left or making a U-turn, shall yield the right-of-way to:

- a. (a) Pedestrians lawfully within an associated crosswalk, and
- b. (b) Other vehicles lawfully within the intersection.

In addition, vehicular traffic turning left or making a U-turn to the left shall yield the right-of-way to other vehicles approaching from the opposite direction so closely as to constitute an immediate hazard during the time when such turning vehicle is moving across or within the intersection.

3. Pedestrians facing any flashing yellow signal indication at an intersection, unless otherwise directed by a pedestrian signal indication or other traffic control device, are permitted to proceed across the roadway within any

marked or unmarked associated crosswalk. Pedestrians shall yield the right-of-way to vehicles lawfully within the intersection at the time that the flashing yellow signal indication is first displayed.

4. When a flashing CIRCULAR YELLOW signal indication(s) is displayed as a beacon (see Chapter 4L) to supplement another traffic control device, road users are notified that there is a need to pay extra attention to the message contained thereon or that the regulatory or warning requirements of the other traffic control device, which might not be applicable at all times, are currently applicable.
- F. Flashing red signal indications shall have the following meanings:
1. Vehicular traffic, on an approach to an intersection, facing a flashing CIRCULAR RED signal indication shall stop at a clearly marked stop line; but if there is no stop line, before entering the crosswalk on the near side of the intersection; or if there is no crosswalk, at the point nearest the intersecting roadway where the driver has a view of approaching traffic on the intersecting roadway before entering the intersection. The right to proceed shall be subject to the rules applicable after making a stop at a STOP sign.
  2. Vehicular traffic, on an approach to an intersection, facing a flashing RED ARROW signal indication if intending to turn in the direction indicated by the arrow shall stop at a clearly marked stop line; but if there is no stop line, before entering the crosswalk on the near side of the intersection; or if there is no crosswalk, at the point nearest the intersecting roadway where the driver has a view of approaching traffic on the intersecting roadway before entering the intersection. The right to proceed with the turn shall be limited to the direction indicated by the arrow and shall be subject to the rules applicable after making a stop at a STOP sign.
  3. Pedestrians facing any flashing red signal indication at an intersection, unless otherwise directed by a pedestrian signal indication or other traffic control device, are permitted to proceed across the roadway within any marked or unmarked associated crosswalk. Pedestrians shall yield the right-of-way to vehicles lawfully within the intersection at the time that the flashing red signal indication is first displayed.
  4. When a flashing CIRCULAR RED signal indication(s) is displayed as a beacon (see Chapter 4L) to supplement another traffic control device, road users are notified that there is a need to pay extra attention to the message contained thereon or that the regulatory requirements of the other traffic control device, which might not be applicable at all times, are currently applicable. Use of this signal indication shall be limited to supplementing STOP (R1-1), DO NOT ENTER (R5-1), or WRONG WAY (R5-1a) signs, and to applications where compliance with the supplemented traffic control device requires a stop at a designated point.



04 **The color amber as referenced in the Code of Virginia § 46.2-833 shall be equivalent to the color yellow as referenced in the MUTCD and the Supplement.**

**Support:**

05—Unless a sign indicates otherwise, the MUTCD allows right turn on red in the presence of a steady CIRCULAR RED indication and prohibits right turn on red in the presence of a steady right turn RED ARROW. The Code of Virginia § 46.2-835, however, allows right turn on red for both steady CIRCULAR RED and steady right turn RED ARROW. Specifically, the code states “except where signs are placed prohibiting turns on steady red, vehicular traffic facing a steady red signal, after coming to a full stop, may cautiously enter the intersection and make a right turn.” Although not specifically defined by the statutes, a red signal is implied to be either a steady CIRCULAR RED or RED ARROW.\*

**Guidance:**

06—Steady right turn RED ARROW signal indications should only be displayed at locations where right turn on red is prohibited. A NO TURN ON RED sign (see Section 2B.54 of the MUTCD) should be installed in conjunction with the steady right turn RED ARROW.\*

**Support:**

07—To reduce potential motorist confusion and misinterpretation of the meaning of signal indications, and to keep the meaning of the steady right turn RED ARROW indication consistent with the MUTCD definition, steady right turn RED ARROW signal indications are not desirable at locations where right turn on red is permitted. The NO TURN ON RED sign is needed to supplement the steady right turn RED ARROW in order to make the right turn on red prohibition legally binding according to The Code of Virginia § 46.2-835.\*

## **Section 4D.05 Application of Steady Signal Indications**

**Standard:**

- 01 **When a traffic control signal is being operated in a steady (stop-and-go) mode, at least one indication in each signal face shall be displayed at any given time.**
- 02 **A signal face(s) that controls a particular vehicular movement during any interval of a cycle shall control that same movement during all intervals of the cycle.**
- 03 **Steady signal indications shall be applied as follows:**
  - A. A steady CIRCULAR RED signal indication:**
    1. **Shall be displayed when it is intended to prohibit traffic, except pedestrians directed by a pedestrian signal head, from entering the intersection or other controlled area. Turning after stopping is permitted as stated in Item C.1 in Paragraph 3 of [Section 4D.04 of this Supplement](#).**
    2. **Shall be displayed with the appropriate GREEN ARROW signal indications when it is intended to permit traffic to make a specified turn or turns, and to prohibit traffic from proceeding straight ahead through the intersection or other controlled area, except in protected only mode operation (see [Sections 4D.19 and 4D.23 of this Supplement](#)), or in protected/permissive**



mode operation with separate turn signal faces (see [Sections 4D.20 and 4D.24 of the MUTCD](#)).

- B. A steady CIRCULAR YELLOW signal indication:**
1. Shall be displayed following a CIRCULAR GREEN or straight-through GREEN ARROW signal indication in the same signal face.
  2. Shall not be displayed in conjunction with the change from the CIRCULAR RED signal indication to the CIRCULAR GREEN signal indication.
  3. Shall be followed by a CIRCULAR RED signal indication except that, when entering preemption operation, the return to the previous CIRCULAR GREEN signal indication shall be permitted following a steady CIRCULAR YELLOW signal indication (see [Section 4D.27 of the MUTCD](#)).
  4. Shall not be displayed to an approach from which drivers are turning left permissively or making a U-turn to the left permissively unless one of the following conditions exists:
    - a. A steady CIRCULAR YELLOW signal indication is also simultaneously being displayed to the opposing approach;
    - b. An engineering study has determined that, because of unique intersection conditions, the condition described in Item (a) cannot reasonably be implemented without causing significant operational or safety problems and that the volume of impacted left-turning or U-turning traffic is relatively low, and those left-turning or U-turning drivers are advised that a steady CIRCULAR YELLOW signal indication is not simultaneously being displayed to the opposing traffic if this operation occurs continuously by the installation near the left-most signal head of a W25-1 sign (see [Section 2C.48 of the MUTCD](#)) with the legend ONCOMING TRAFFIC HAS EXTENDED GREEN; or
    - c. Drivers are advised of the operation if it occurs only occasionally, such as during a preemption sequence, by the installation near the left-most signal head of a W25-2 sign (see [Section 2C.48 of the MUTCD](#)) with the legend ONCOMING TRAFFIC MAY HAVE EXTENDED GREEN.
- C. A steady CIRCULAR GREEN signal indication shall be displayed only when it is intended to permit traffic to proceed in any direction that is lawful and practical.**
- D. A steady RED ARROW signal indication shall be displayed when it is intended to prohibit traffic, except pedestrians directed by a pedestrian signal head, from entering the intersection or other controlled area to make the indicated turn. Except as described in Item C.2 in Paragraph 3 of [Section 4D.04 of this Supplement](#), turning on a steady RED ARROW signal indication shall not be permitted.**
- E. A steady YELLOW ARROW signal indication:**
1. Shall be displayed in the same direction as a GREEN ARROW signal indication following a GREEN ARROW signal indication in the same signal face, unless:

- a. The GREEN ARROW signal indication and a CIRCULAR GREEN (or straight-through GREEN ARROW) signal indication terminate simultaneously in the same signal face, or
  - b. The green arrow is a straight-through GREEN ARROW (see Item B.1).
2. Shall be displayed in the same direction as a flashing YELLOW ARROW signal indication or flashing RED ARROW signal indication following a flashing YELLOW ARROW signal indication or flashing RED ARROW signal indication in the same signal face, when the flashing arrow indication is displayed as part of a steady mode operation, if the signal face will subsequently display a steady red signal indication.
3. Shall not be displayed in conjunction with the change from a steady RED ARROW, flashing RED ARROW, or flashing YELLOW ARROW signal indication to a GREEN ARROW signal indication, except when entering preemption operation as provided in Item 5(a).
4. Shall not be displayed when any conflicting vehicular movement has a green or yellow signal indication (except for the situation regarding U-turns to the left provided in Paragraph 4) or any conflicting pedestrian movement has a WALKING PERSON (symbolizing WALK) or flashing UPRAISED HAND (symbolizing DONT WALK) signal indication, except that a steady left-turn (or U-turn to the left) YELLOW ARROW signal indication used to terminate a flashing left-turn (or U-turn to the left) YELLOW ARROW or a flashing left-turn (or U-turn to the left) RED ARROW signal indication in a signal face controlling a permissive left-turn (or U-turn to the left) movement as described in [Section 4D.18 of this Supplement and Section 4D.20 of the MUTCD](#) shall be permitted to be displayed when a CIRCULAR YELLOW signal indication is displayed for the opposing through movement. Vehicles departing in the same direction shall not be considered in conflict if, for each turn lane with moving traffic, there is a separate departing lane, and pavement markings or raised channelization clearly indicate which departure lane to use.
5. Shall not be displayed to terminate a flashing arrow signal indication on an approach from which drivers are turning left permissively or making a U-turn to the left permissively unless one of the following conditions exists:
  - a. A steady CIRCULAR YELLOW signal indication is also simultaneously being displayed to the opposing approach;
  - b. An engineering study has determined that, because of unique intersection conditions, the condition described in Item (a) cannot reasonably be implemented without causing significant operational or safety problems and that the volume of impacted left-turning or U-turning traffic is relatively low, and those left-turning or U-turning drivers are advised that a steady CIRCULAR YELLOW signal indication is not simultaneously being displayed to the opposing traffic if this operation occurs continuously by the installation near

- the left-most signal head of a W25-1 sign (see Section 2C.48 of the MUTCD) with the legend ONCOMING TRAFFIC HAS EXTENDED GREEN; or
- c. Drivers are advised of the operation if it occurs only occasionally, such as during a preemption sequence, by the installation near the left-most signal head of a W25-2 sign (see Section 2C.48 of the MUTCD) with the legend ONCOMING TRAFFIC MAY HAVE EXTENDED GREEN.
6. Shall be terminated by a RED ARROW signal indication for the same direction or a CIRCULAR RED signal indication except:
- a. When entering preemption operation, the display of a GREEN ARROW signal indication or a flashing arrow signal indication shall be permitted following a steady YELLOW ARROW signal indication.
  - b. When the movement controlled by the arrow is to continue on a permissive mode basis during an immediately following CIRCULAR GREEN or flashing YELLOW ARROW signal indication.
- F. A steady GREEN ARROW signal indication:
1. Shall be displayed only to allow vehicular movements, in the direction indicated, that are not in conflict with other vehicles moving on a green or yellow signal indication and are not in conflict with pedestrians crossing in compliance with a WALKING PERSON (symbolizing WALK) or flashing UPRaised HAND (symbolizing DONT WALK) signal indication. Vehicles departing in the same direction shall not be considered in conflict if, for each turn lane with moving traffic, there is a separate departing lane, and pavement markings or raised channelization clearly indicate which departure lane to use.
  2. Shall be displayed on a signal face that controls a left-turn movement when said movement is not in conflict with other vehicles moving on a green or yellow signal indication (except for the situation regarding U-turns provided in Paragraph 7) and is not in conflict with pedestrians crossing in compliance with a WALKING PERSON (symbolizing WALK) or flashing UPRaised HAND (symbolizing DONT WALK) signal indication. Vehicles departing in the same direction shall not be considered in conflict if, for each turn lane with moving traffic, there is a separate departing lane, and pavement markings or raised channelization clearly indicate which departure lane to use.
  3. Shall not be required on the stem of a T-intersection or for turns from a one-way street.

**Support:**

04—Unless a sign indicates otherwise, the MUTCD allows right turn on red in the presence of a steady CIRCULAR RED indication and prohibits right turn on red in the presence of a steady right turn RED ARROW. The Code of Virginia § 46.2-835, however, allows right turn on red for both steady CIRCULAR RED and steady right turn RED ARROW.\*

Specifically, the code states “except where signs are placed prohibiting turns on steady red, vehicular traffic facing a steady red signal, after coming to a full stop, may cautiously enter the intersection and make a right turn.” Although not specifically defined by the statutes, a red signal is implied to be either a steady CIRCULAR RED or RED ARROW. \*

**Guidance:**

05—Steady right turn RED ARROW signal indications should only be displayed at locations where right turn on red is prohibited. A NO TURN ON RED sign (see Section 2B.54 of the MUTCD) should be installed in conjunction with the steady right turn RED ARROW.\*

**Support:**

06—To reduce potential motorist confusion and misinterpretation of the meaning of signal indications, and to keep the meaning of the steady right turn RED ARROW indication consistent with the MUTCD definition, steady right turn RED ARROW signal indications are not desirable at locations where right turn on red is permitted. The NO TURN ON RED sign is needed to supplement the steady right turn RED ARROW in order to make the right turn on red prohibition legally binding according to the Code of Virginia § 46.2-835.\*

**Option:**

0704 If U-turns are permitted from the approach and a right-turn GREEN ARROW signal indication is simultaneously being displayed to road users making a right turn from the conflicting approach to the left, road users making a U-turn may be advised of the operation by the installation near the left-turn signal face of a U-TURN YIELD TO RIGHT TURN (R10-16) sign (see Section 2B.53 of this Supplement).

0805 If not otherwise prohibited, a steady straight-through green arrow signal indication may be used instead of a circular green signal indication in a signal face on an approach intersecting a one-way street to discourage wrong-way turns.

0906 If not otherwise prohibited, steady red, yellow, and green turn arrow signal indications may be used instead of steady circular red, yellow, and green signal indications in a signal face on an approach where all traffic is required to turn or where the straight-through movement is not physically possible.

**Support:**

1007 Section 4D.25 of the MUTCD contains information regarding the signalization of approaches that have a shared left-turn/right-turn lane and no through movement.

**Standard:**

1108 If supplemental signal faces are used, the following limitations shall apply:

- A. Left-turn arrows and U-turn arrows to the left shall not be used in near-right signal faces.
- B. Right-turn arrows and U-turn arrows to the right shall not be used in far-left signal faces. A far-side median-mounted signal face shall be considered a far-left signal for this application.

**4209** A straight-through RED ARROW signal indication or a straight-through YELLOW ARROW signal indication shall not be displayed on any signal face, either alone or in combination with any other signal indication.

**4310** The following combinations of signal indications shall not be simultaneously displayed on any one signal face:

- A. CIRCULAR RED with CIRCULAR YELLOW;
- B. CIRCULAR GREEN with CIRCULAR RED; or
- C. Straight-through GREEN ARROW with CIRCULAR RED;

**4411** Additionally, the above combinations shall not be simultaneously displayed on an approach as a result of the combination of displays from multiple signal faces unless the display is created by a signal face(s) devoted exclusively to the control of a right-turning movement and:

- A. The signal face(s) controlling the right-turning movement is visibility-limited from the adjacent through movement or positioned to minimize potential confusion to approaching road users, or
- B. A RIGHT TURN SIGNAL (R10-10) sign (see Sections 4D.21, 4D.22, and 4D.24 of the MUTCD and Section 4D.23 in this Supplement) is mounted adjacent to the signal face(s) controlling the right-turning movement.

Option:

**4512** A right-turn GREEN ARROW may be considered if the right-turning volume exceeds 200 vehicles per hour.

Support:

**4613** The Code of Virginia, § 46.2-825 requires that U-turns yield to right-turns when a conflict exists. Such conflicts could be avoided for turning vehicles entering the same receiving lanes, by installing either a right-turn GREEN ARROW or allowing a U-turn movement, but not both at the same time entering the same receiving lanes.

Guidance:

**4714** *When a right-turn GREEN ARROW controls the right-turn movement, a conflicting U-turn movement to the same receiving lanes should be prohibited. If the U-turn movement is necessary or deserves priority based on engineering judgment, then the right-turn GREEN ARROW should not be displayed during the U-turn movement.*

Standard:

**4815** The following combinations of signal indications shall not be simultaneously displayed on any one signal face or as a result of the combination of displays from multiple signal faces on an approach:

- A. CIRCULAR GREEN with CIRCULAR YELLOW;
- B. Straight-through GREEN ARROW with CIRCULAR YELLOW;
- C. GREEN ARROW with YELLOW ARROW pointing in the same direction;
- D. RED ARROW with YELLOW ARROW pointing in the same direction; or
- E. GREEN ARROW with RED ARROW pointing in the same direction.



**1916** Except as otherwise provided in **Sections 4F.03 and 4G.04 of the MUTCD**, the same signal section shall not be used to display both a flashing yellow and a steady yellow indication during steady mode operation. Except as otherwise provided in **Section 4D.18 of this Supplement and Sections 4D.20, 4D.22, and 4D.24 of the MUTCD**, the same signal section shall not be used to display both a flashing red and a steady red indication during steady mode operation.

*Guidance:*

**2017** *No movement that creates an unexpected crossing of pathways of moving vehicles or pedestrians should be allowed during any green or yellow interval, except when all three of the following conditions are met:*

- A. *The movement involves only slight conflict, and*
- B. *Serious traffic delays are substantially reduced by permitting the conflicting movement, and*
- C. *Drivers and pedestrians subjected to the unexpected conflict are effectively warned thereof by a sign.*

## **Section 4D.12 Visibility, Aiming, and Shielding of Signal Faces**

**Standard:**

- 01** The primary consideration in signal face placement, aiming, and adjustment shall be to optimize the visibility of signal indications to approaching traffic.
- 02** Road users approaching a signalized intersection or other signalized area, such as a midblock crosswalk, shall be given a clear and unmistakable indication of their right-of-way assignment.
- 03** The geometry of each intersection to be signalized, including vertical grades, horizontal curves, and obstructions as well as the lateral and vertical angles of sight toward a signal face, as determined by typical driver-eye position, shall be considered in determining the vertical, longitudinal, and lateral position of the signal face.

*Guidance:*

- 04** *The two primary signal faces required as a minimum for each approach should be continuously visible to traffic approaching the traffic control signal, from a point at least the minimum sight distance provided in Table 4D-2 in advance of and measured to the stop line. This range of continuous visibility should be provided unless precluded by a physical obstruction or unless another signalized location is within this range.*
- 05** *There should be legal authority to prohibit the display of any unauthorized sign, signal, marking, or device that interferes with the effectiveness of any official traffic control device (see Section 11-205 of the "Uniform Vehicle Code").*
- 06** *At signalized midblock crosswalks, at least one of the signal faces should be over the traveled way for each approach.*

**Table 4D-2. Minimum Sight Distance for Signal Visibility**

85th-Percentile Speed	Minimum Sight Distance
20 mph	175 feet
25 mph	215 feet
30 mph	270 feet
35 mph	325 feet
40 mph	390 feet
45 mph	460 feet
50 mph	540 feet
55 mph	625 feet
60 mph	715 feet

Note: Distances in this table are derived from stopping sight distance plus an assumed queue length for shorter cycle lengths (60 to 75 seconds).

**Standard:**

- 07 **If approaching traffic does not have a continuous view of at least two signal faces for at least the minimum sight distance shown in Table 4D-2, a sign (see Section 2C.36 of the MUTCD) shall be installed to warn approaching traffic of the traffic control signal.**

**Option:**

- 08 If a sign is installed to warn approaching road users of the traffic control signal, the sign may be supplemented by a Warning Beacon (see Section 4L.03 of the MUTCD).
- 09 A Warning Beacon used in this manner may be interconnected with the traffic signal controller assembly in such a manner as to flash yellow during the period when road users passing this beacon at the legal speed for the roadway might encounter a red signal indication (or a queue resulting from the display of the red signal indication) upon arrival at the signalized location.
- 10 If the sight distance to the signal faces for an approach is limited by horizontal or vertical alignment, supplemental signal faces aimed at a point on the approach at which the signal indications first become visible may be used.

**Guidance:**

- 11 *Supplemental signal faces should be used if engineering judgment has shown that they are needed to achieve intersection visibility both in advance and immediately before the signalized location.*
- 12 *If supplemental signal faces are used, they should be located to provide optimum visibility for the movement to be controlled.*



**Standard:**

- 13 **In cases where irregular street design necessitates placing signal faces for different street approaches with a comparatively small angle between their respective signal indications, each signal indication shall, to the extent practical, be visibility-limited by signal visors, signal louvers, or other means so that an approaching road user's view of the signal indication(s) controlling movements on other approaches is minimized.**
- 14 **Signal visors exceeding 12 inches in length shall not be used on free-swinging signal faces.**

*Guidance:*

- 15 *Signal visors should be used on signal faces to aid in directing the signal indication specifically to approaching traffic, as well as to reduce "sun phantom," which can result when external light enters the lens.*
- 16 *The use of signal visors, or the use of signal faces or devices that direct the light without a reduction in intensity, should be considered as an alternative to signal louvers because of the reduction in light output caused by signal louvers.*

**Option:**

- 17 Special signal faces, such as visibility-limited signal faces, may be used such that the road user does not see signal indications intended for other approaches before seeing the signal indications for their own approach, if simultaneous viewing of both signal indications could cause the road user to be misdirected.

*Guidance:*

- 18 *Signal backplates should be installed on all signal faces.*

**Standard:**

- 19 **Backplates shall be installed on signal faces if at least one of the following is true: the posted or statutory speed limit or the 85th-percentile speed on an approach to a signalized location is 45 mph or higher, sun glare or bright sky is frequent, or where complex or confusing backgrounds indicate a need for enhanced signal face target value.**

**Support:**

- 20 The use of backplates enhances the contrast between the traffic signal indications and their surroundings for both day and night conditions, which is also helpful to older drivers.

**Standard:**

- 21 **The inside of signal visors (hoods), the entire surface of louvers and fins, and the front surface of backplates shall have a dull black finish to minimize light reflection and to increase contrast between the signal indication and its background.**

**Option:**

- 22 A yellow retroreflective strip with a minimum width of 1 inch and a maximum width of 3 inches may be placed along the perimeter of the face of a signal backplate to project a rectangular appearance at night.



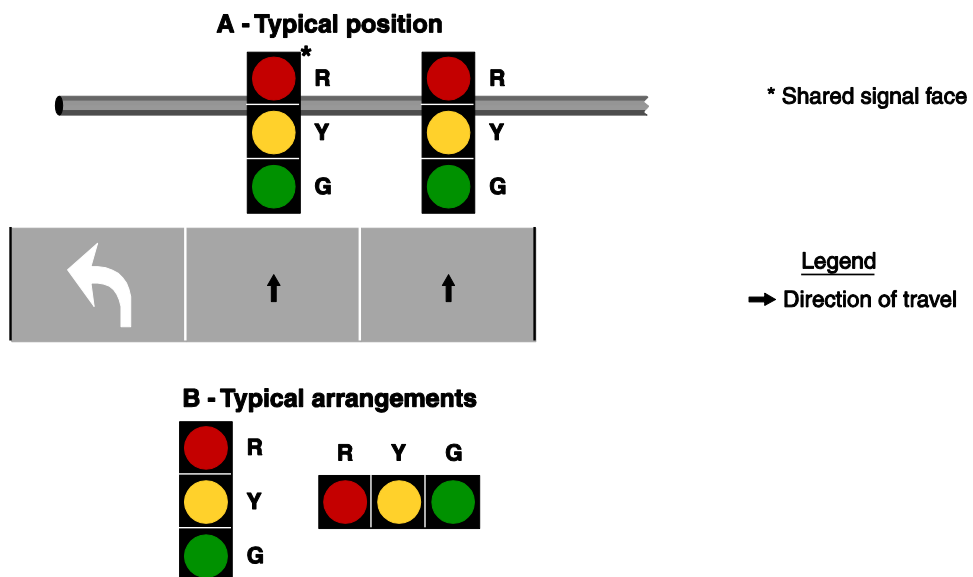


## Section 4D.18 Signal Indications for Permissive Only Mode Left-Turn Movements

**Standard:**

- 01 If a shared signal face is provided for a permissive only mode left turn, it shall meet the following requirements (see Figure 4D-6):
  - A. It shall be capable of displaying the following signal indications: steady CIRCULAR RED, steady CIRCULAR YELLOW, and CIRCULAR GREEN. Only one of the three indications shall be displayed at any given time.
  - B. During the permissive left-turn movement, a CIRCULAR GREEN signal indication shall be displayed.
  - C. A permissive only shared signal face, regardless of where it is positioned and regardless of how many adjacent through signal faces are provided, shall always simultaneously display the same color of circular indication that the adjacent through signal face or faces display.
  - D. If the permissive only mode is not the only left-turn mode used for the approach, the signal face shall be the same shared signal face that is used for the protected/permissive mode (see [Section 4D.20 of the MUTCD](#)) except that the left-turn GREEN ARROW and left-turn YELLOW ARROW signal indications shall not be displayed when operating in the permissive only mode.
- 02 If a separate left-turn signal face is being operated in a permissive only left-turns mode, a CIRCULAR GREEN signal indication shall not be used in that face.

**Figure 4D-6. Typical Position and Arrangements of Shared Signal Faces for Permissive Only Mode Left Turns**



- 03 **If a separate left-turn signal face is being operated in a permissive only left-turn mode and a flashing left-turn YELLOW ARROW signal indication is provided, it shall meet the following requirements (see [Figure 4D-7\(VA\)](#) in this Supplement):**
- A. It shall be capable of displaying the following signal indications: steady left-turn RED ARROW, steady left-turn YELLOW ARROW, and flashing left-turn YELLOW ARROW. Only one of the three indications shall be displayed at any given time.**
  - B. During the permissive left-turn movement, a flashing left-turn YELLOW ARROW signal indication shall be displayed.**
  - C. A steady left-turn YELLOW ARROW signal indication shall be displayed following the flashing left-turn YELLOW ARROW signal indication.**
  - D. It shall be permitted to display a flashing left-turn YELLOW ARROW signal indication for a permissive left-turn movement while the signal faces for the adjacent through movement display steady CIRCULAR RED signal indications and the opposing left-turn signal faces display left-turn GREEN ARROW signal indications for a protected left-turn movement.**
  - E. During steady mode (stop-and-go) operation, the signal section that displays the steady left-turn YELLOW ARROW signal indication during change intervals shall not be used to display the flashing left-turn YELLOW ARROW signal indication for permissive left turns.**
  - F. During flashing mode operation (see [Section 4D.30 of the MUTCD](#)), the display of a flashing left-turn YELLOW ARROW signal indication shall be only from the signal section that displays a steady left-turn YELLOW ARROW signal indication during steady mode (stop-and-go) operation.**
  - G. If the permissive only mode is not the only left-turn mode used for the approach, the signal face shall be the same separate left-turn signal face with a flashing YELLOW ARROW signal indication that is used for the protected/permissive mode (see [Section 4D.20 of the MUTCD](#)) except that the left-turn GREEN ARROW signal indication shall not be displayed when operating in the permissive only mode.**

*Guidance:*

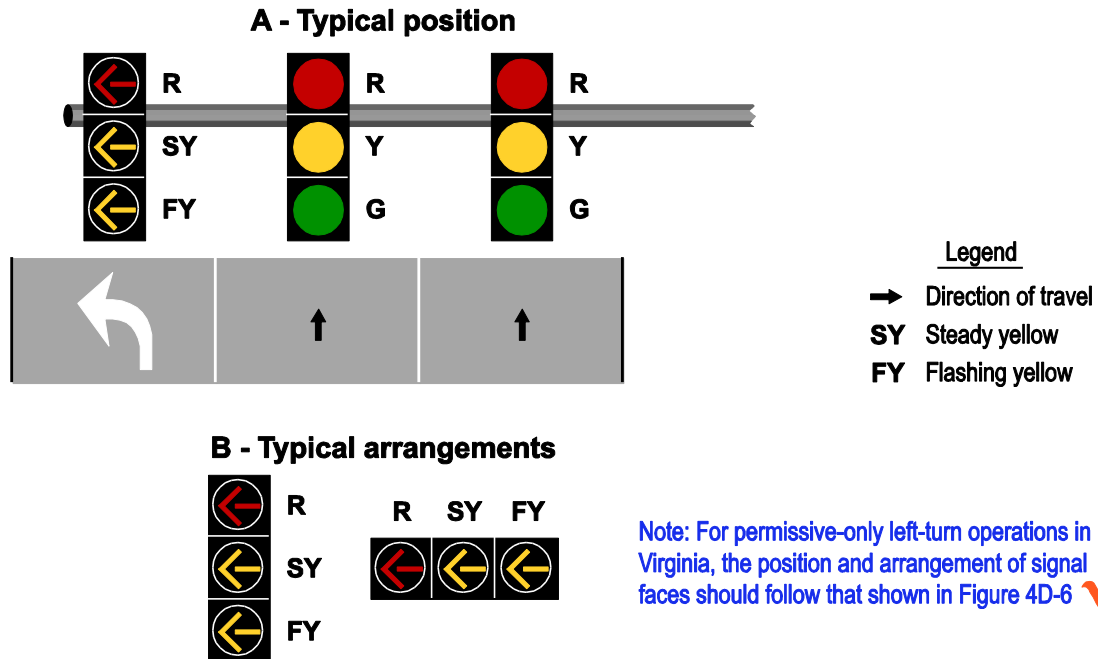
- 04 *If a left-turn movement is operated in a permissive only mode at all times, a shared signal face with a steady CIRCULAR GREEN signal indication should be used instead of a separate left-turn signal face with a flashing YELLOW ARROW indication.*

*Support:*

- 05 NCHRP studies are inconclusive regarding the benefits of flashing YELLOW ARROW for permissive only left-turn situations. In order to maintain uniformity, consistency, and driver expectations, the use of the flashing YELLOW ARROW at permissive only left-turns is discouraged in favor of the steady CIRCULAR GREEN indication. The flashing YELLOW ARROW can still be utilized at protected/permissive mode left-turns (see [Section 4D.20 of the MUTCD](#)).



## Figure 4D-7(VA). Typical Position and Arrangements of Separate Signal Faces with Flashing Yellow Arrow for Permissive Only Mode Left Turns



Option:

- 06 A separate left-turn signal face with a flashing left-turn RED ARROW signal indication during the permissive left-turn movement may be used for unusual geometric conditions, such as wide medians with offset left-turn lanes, but only when an engineering study determines that each and every vehicle must successively come to a full stop before making a permissive left turn.

**Standard:**

- 07 If a separate left-turn signal face is being operated in a permissive only left-turn mode and a flashing left-turn RED ARROW signal indication is provided, it shall meet the following requirements (see Figure 4D-8):
- A. It shall be capable of displaying the following signal indications: steady or flashing left-turn RED ARROW, steady left-turn YELLOW ARROW, and left-turn GREEN ARROW. Only one of the three indications shall be displayed at any given time. The GREEN ARROW indication is required in order to provide a three-section signal face, but shall not be displayed during the permissive only mode.
  - B. During the permissive left-turn movement, a flashing left-turn RED ARROW signal indication shall be displayed, thus indicating that each and every vehicle must successively come to a full stop before making a permissive left turn.

- C. A steady left-turn YELLOW ARROW signal indication shall be displayed following the flashing left-turn RED ARROW signal indication.
- D. It shall be permitted to display a flashing left-turn RED ARROW signal indication for a permissive left-turn movement while the signal faces for the adjacent through movement display steady CIRCULAR RED signal indications and the opposing left-turn signal faces display left-turn GREEN ARROW signal indications for a protected left-turn movement.
- E. A supplementary sign shall not be required. If used, it shall be a LEFT TURN YIELD ON FLASHING RED ARROW AFTER STOP (R10-27) sign (see [Figure 2B-27\(VA\) in this Supplement](#)).

Option:

- 08 The requirements of Item A in [Paragraph 7](#) may be met by a vertically-arranged signal face with a horizontal cluster of two left-turn RED ARROW signal indications, the left-most of which displays a steady indication and the right-most of which displays a flashing indication (see [Figure 4D-8](#)).

## **Section 4D.19 Signal Indications for Protected Only Mode Left-Turn Movements**

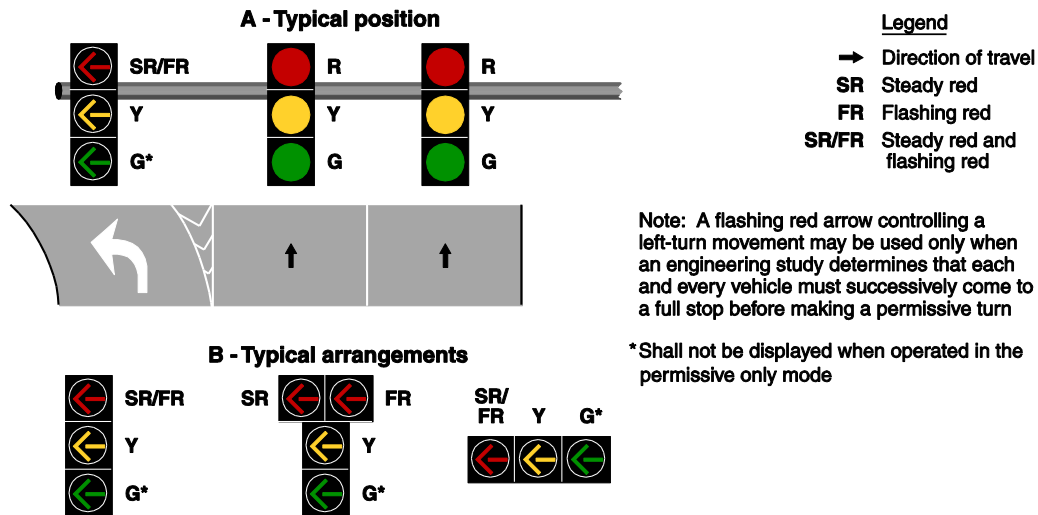
Standard:

- 01 A shared signal face shall not be used for protected only mode left turns unless the CIRCULAR GREEN and left-turn GREEN ARROW signal indications always begin and terminate together. If a shared signal face is provided for a protected only mode left turn, it shall meet the following requirements (see [Figure 4D-9](#)):
  - A. It shall be capable of displaying the following signal indications: steady CIRCULAR RED, steady CIRCULAR YELLOW, CIRCULAR GREEN, and left-turn GREEN ARROW. Only one of the three colors shall be displayed at any given time.
  - B. During the protected left-turn movement, the shared signal face shall simultaneously display both a CIRCULAR GREEN signal indication and a left-turn GREEN ARROW signal indication.
  - C. The shared signal face shall always simultaneously display the same color of circular indication that the adjacent through signal face or faces display.
  - D. If the protected only mode is not the only left-turn mode used for the approach, the signal face shall be the same shared signal face that is used for the protected/permissive mode (see [Section 4D.20 of the MUTCD](#)).

Option:

- 02 A straight-through GREEN ARROW signal indication may be used instead of the CIRCULAR GREEN signal indication in Items A and B in [Paragraph 1](#) on an approach where right turns are prohibited and a straight-through GREEN ARROW signal indication is also used instead of a CIRCULAR GREEN signal indication in the other signal face(s) for through traffic.

## Figure 4D-8. Typical Position and Arrangements of Separate Signal Faces with Flashing Red Arrow for Permissive Only Mode and Protected/Permissive Mode Left Turns



### Standard:

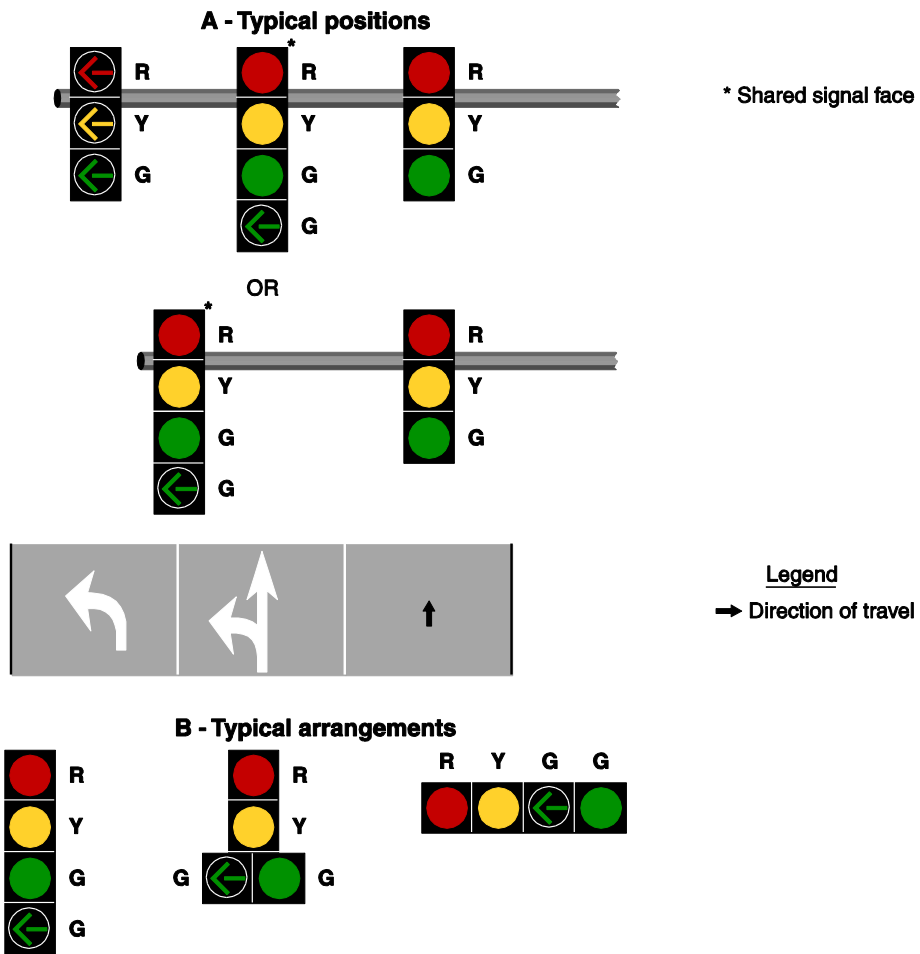
- 03 If a separate left-turn signal face is provided for a protected only mode left turn, it shall meet the following requirements (see Figure 4D-10):
- A. It shall be capable of displaying, the following signal indications: steady left-turn RED ARROW, steady left-turn YELLOW ARROW, and left-turn GREEN ARROW. Only one of the three indications shall be displayed at any given time. A signal instruction sign shall not be required with this set of signal indications. If used, it shall be a LEFT ON GREEN ARROW ONLY (R10-5) sign (see [Figure 2B-27\(VA\) in this Supplement](#)).
  - B. During the protected left-turn movement, a left-turn GREEN ARROW signal indication shall be displayed.
  - C. A steady left-turn YELLOW ARROW signal indication shall be displayed following the left-turn GREEN ARROW signal indication.
  - D. If the protected only mode is not the only left-turn mode used for the approach, the signal face shall be the same separate left-turn signal face that is used for the protected/permissive mode (see [Section 4D.20 of the MUTCD](#) and Figures 4D-8 and 4D-12) except that the flashing left-turn YELLOW ARROW or flashing left-turn RED ARROW signal indication shall not be displayed when operating in the protected only mode.

### Guidance:

- 04 *The LEFT ON GREEN ARROW ONLY sign (R10-5) should be used only after engineering judgment reveals a problem that could be mitigated by the sign.*

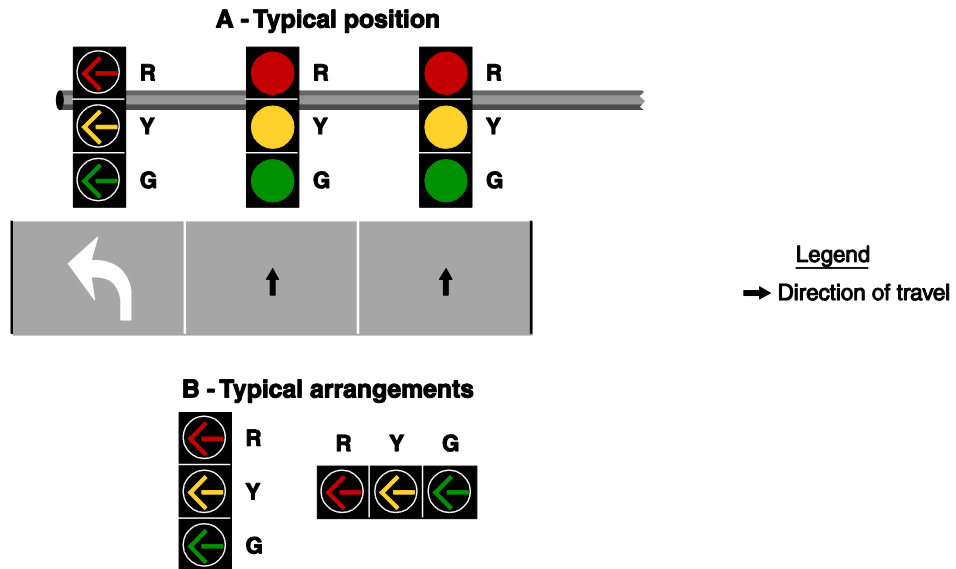


**Figure 4D-9 Typical Positions and Arrangements of Shared Signal Faces for Protected Only Mode Left Turns**

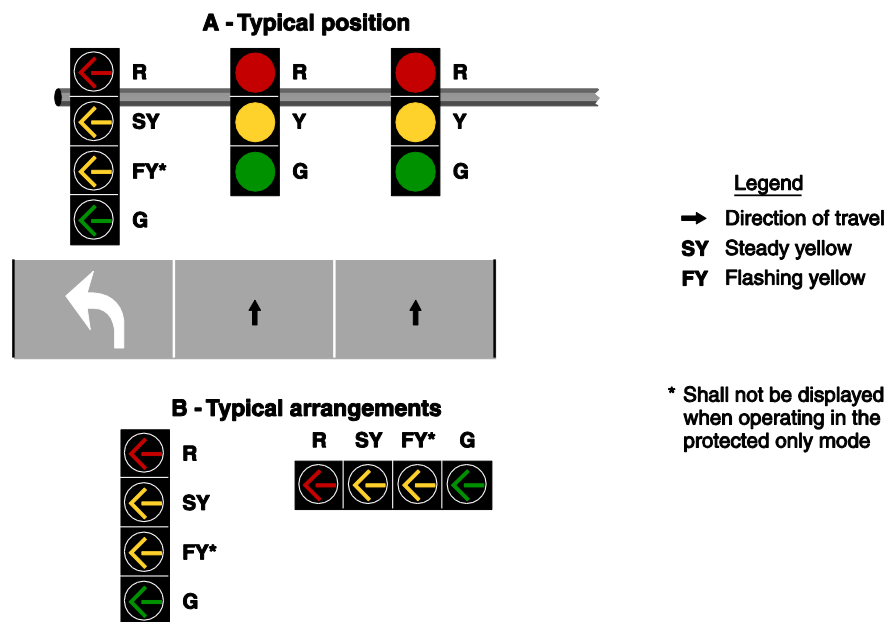


Note: Shared signal faces shall only be used for a protected-only mode left turn if the circular green and green left-turn arrow indications always begin and terminate together

**Figure 4D-10 Typical Position and Arrangements of Separate Signal Faces for Protected Only Mode Left Turns**



**Figure 4D-12. Typical Position and Arrangements of Separate Signal Faces with Yellow Arrow for Protected/Permissive Mode and Protected Only Mode Left Turns**



## **Section 4D.23 Signal Indications for Protected Only Mode**

### **Right-Turn Movements**

#### **Standard:**

- 01 A shared signal face shall not be used for protected only mode right turns unless the CIRCULAR GREEN and right-turn GREEN ARROW signal indications always begin and terminate together. If a shared signal face is provided for a protected only right turn, it shall meet the following requirements (see Figure 4D-16):
- A. It shall be capable of displaying the following signal indications: steady CIRCULAR RED, steady CIRCULAR YELLOW, CIRCULAR GREEN, and right-turn GREEN ARROW. Only one of the three colors shall be displayed at any given time.
  - B. During the protected right-turn movement, the shared signal face shall simultaneously display both a CIRCULAR GREEN signal indication and a right-turn GREEN ARROW signal indication.
  - C. The shared signal face shall always simultaneously display the same color of circular indication that the adjacent through signal face or faces display.
  - D. If the protected only mode is not the only right-turn mode used for the approach, the signal face shall be the same shared signal face that is used for the protected/permissive mode (see [Section 4D.24 of the MUTCD](#)).

#### **Option:**

- 02 A straight-through GREEN ARROW signal indication may be used instead of the CIRCULAR GREEN signal indication in Items A and B in Paragraph 1 on an approach where left turns are prohibited and a straight-through GREEN ARROW signal indication is also used instead of a CIRCULAR GREEN signal indication in the other signal face(s) for through traffic.

#### **Standard:**

- 03 If a separate right-turn signal face is provided for a protected only mode right turn, it shall meet the following requirements (see Figure 4D-17):

#### **A. It shall be capable of displaying one of the following sets of signal indications:**

1. Steady right-turn RED ARROW, steady right-turn YELLOW ARROW, and right-turn GREEN ARROW. Only one of the three indications shall be displayed at any given time. A signal instruction sign shall not be required with this set of signal indications. If used, it shall be a RIGHT ON GREEN ARROW ONLY (R10-5a) sign (see [Figure 2B-27\(VA\) in this Supplement](#)).
2. **(The following section has been added as its own subparagraph to the Virginia Supplement to the MUTCD in Revision 1. The text, as written, is not new.)\*** Steady CIRCULAR RED, steady right-turn YELLOW ARROW, and right-turn GREEN ARROW. Only one of three indications shall be displayed at any given time. If the CIRCULAR RED signal indication is sometimes displayed when the signal faces for the adjacent through lane(s) are not displaying a CIRCULAR RED signal indication, a RIGHT TURN SIGNAL (R10-





10R) sign (see Figure 2B-27(VA) in this Supplement) shall be used unless the CIRCULAR RED signal indication is shielded, hooded, louvered, positioned, or designed such that it is not readily visible to drivers in the through lane(s). Full tunnel visors alone do not meet the requirement for a signal indication that is shielded, hooded, louvered, positioned, or designed such that it is not readily visible to drivers in the through lane(s).\*

- B. During the protected right-turn movement, a right-turn GREEN ARROW signal indication shall be displayed.
- C. A steady right-turn YELLOW ARROW signal indication shall be displayed following the right-turn GREEN ARROW signal indication.
- D. When the separate signal face is providing a message to stop and remain stopped, a steady right-turn RED ARROW signal indication, ~~along with the NO TURN ON RED (R10-11a) sign,~~\* shall be displayed if it is intended that right turns on red not be permitted ~~(the following parenthetical text from the MUTCD, which formerly appeared as struck-through in the Supplement, has been restored)~~ (except when a traffic control device is in place permitting a turn on a steady RED ARROW signal indication)\* or a steady CIRCULAR RED signal indication shall be displayed if it is intended that right turns on red be permitted.
- E. If the protected only mode is not the only right-turn mode used for the approach, the signal face shall be the same separate right-turn signal face that is used for the protected/permissive mode (see Section 4D.24 of the MUTCD and Figure 4D-19) except that a flashing right-turn YELLOW ARROW or flashing right-turn RED ARROW signal indication shall not be displayed when operating in the protected only mode.

**Support:**

04—Unless a sign indicates otherwise, the MUTCD allows right turn on red in the presence of a steady CIRCULAR RED indication and prohibits right turn on red in the presence of a steady right turn RED ARROW. The Code of Virginia § 46.2-835, however, allows right turn on red for both steady CIRCULAR RED and steady right turn RED ARROW. Specifically, the code states “except where signs are placed prohibiting turns on steady red, vehicular traffic facing a steady red signal, after coming to a full stop, may cautiously enter the intersection and make a right turn.” Although not specifically defined by the statutes, a red signal is implied to be either a steady CIRCULAR RED or RED ARROW.\*

**Guidance:**

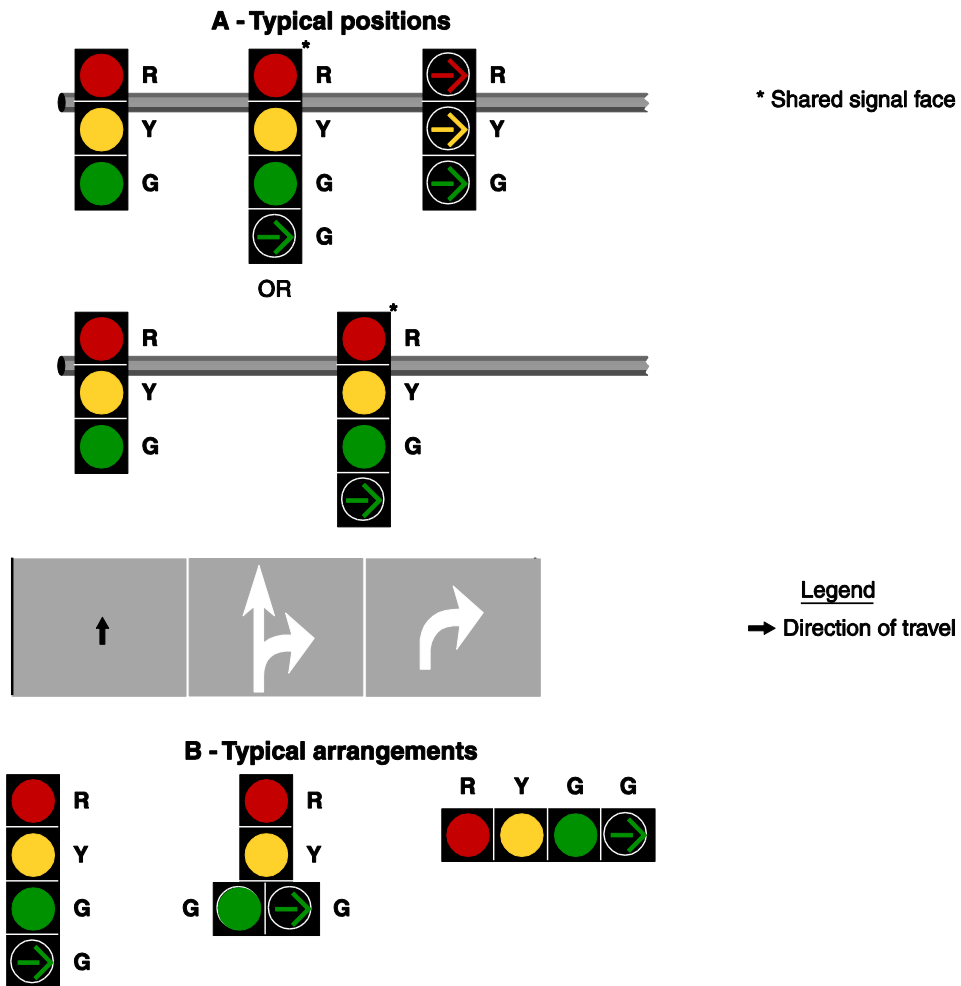
05—Steady right turn RED ARROW signal indications should only be displayed at locations where right turn on red is prohibited. A NO TURN ON RED sign (see Section 2B.54 of the MUTCD) should be installed in conjunction with the steady right turn RED ARROW.\*

**Support:**

06—To reduce potential motorist confusion and misinterpretation of the meaning of signal indications, and to keep the meaning of the steady right turn RED ARROW indication consistent with the MUTCD definition, steady right turn RED ARROW signal indications are not desirable at locations where right turn on red is permitted. The NO TURN ON

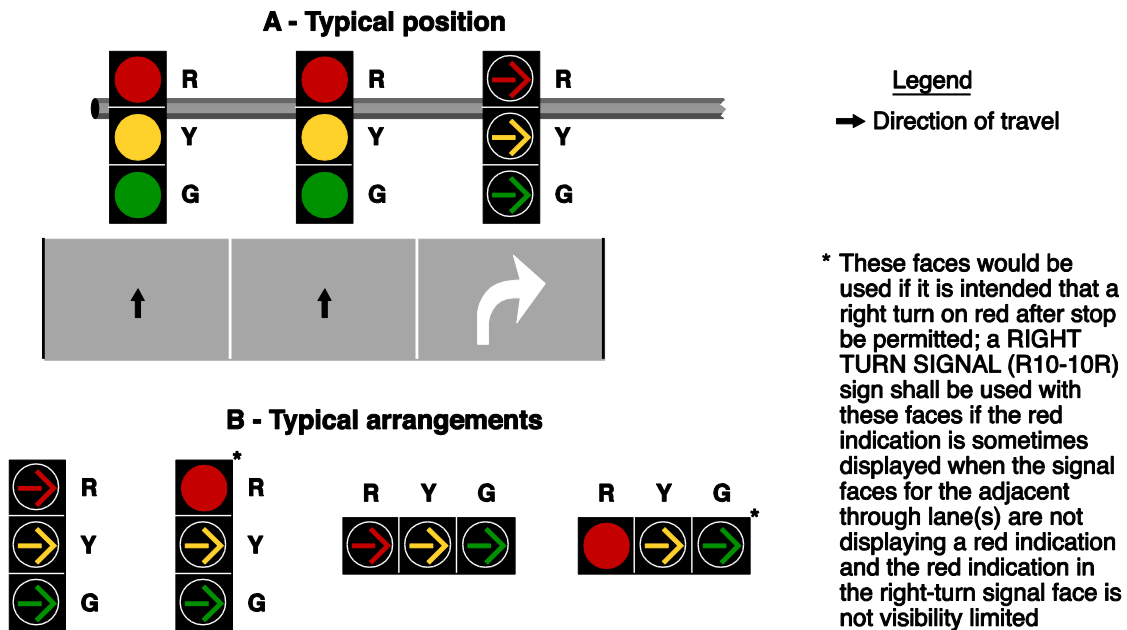
RED sign is needed to supplement the steady right turn RED ARROW in order to make the right turn on red prohibition legally binding according to the Code of Virginia § 46.2-835.\*

**Figure 4D-16 Typical Positions and Arrangements of Shared Signal Faces for Protected Only Mode Right Turns**

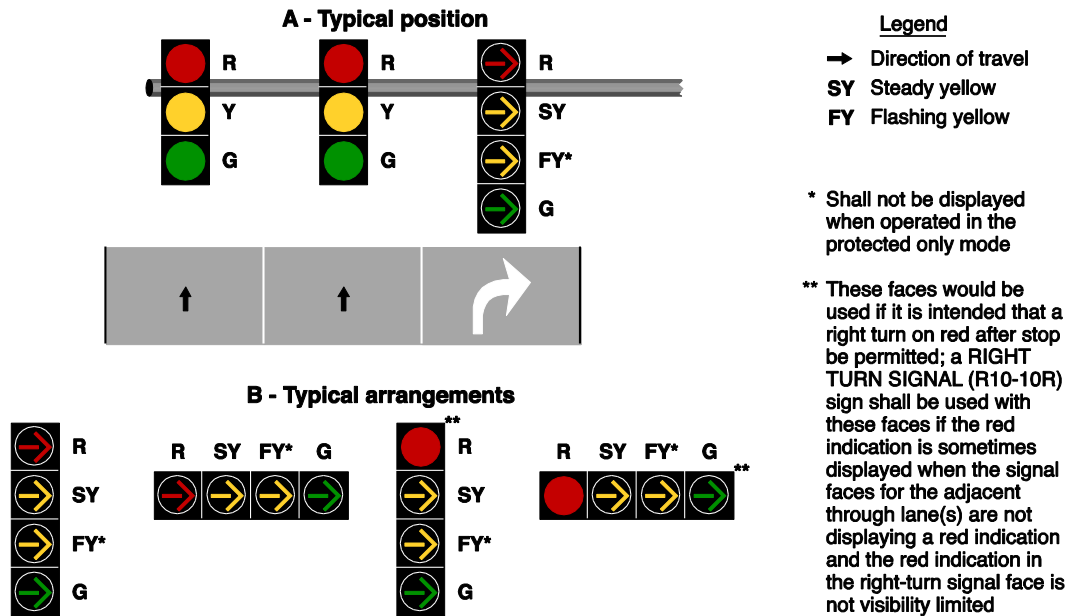


Note: Shared signal faces shall only be used for a protected-only mode right turn if the circular green and green right-turn arrow indications always begin and terminate together

### Figure 4D-17 Typical Positions and Arrangements of Separate Signal Faces for Protected Only Mode Right Turns



## Figure 4D-19 Typical Positions and Arrangements of Separate Signal Faces with Flashing Yellow Arrow for Protected/Permissive Mode and Protected Only Mode Right Turns



### Section 4D.26 Yellow Change and Red Clearance Intervals

#### Standard:

- 01 A steady yellow signal indication shall be displayed following every CIRCULAR GREEN or GREEN ARROW signal indication and following every flashing YELLOW ARROW or flashing RED ARROW signal indication displayed as a part of a steady mode operation. This requirement shall not apply when a CIRCULAR GREEN, a flashing YELLOW ARROW, or a flashing RED ARROW signal indication is followed immediately by a GREEN ARROW signal indication.
- 02 The exclusive function of the yellow change interval shall be to warn traffic of an impending change in the right-of-way assignment.
- 03 The duration of the yellow change interval shall be determined using engineering practices.

#### Support:

- 04 [Section 4D.05 of this Supplement](#) contains provisions regarding the display of steady CIRCULAR YELLOW signal indications to approaches from which drivers are allowed to make permissive left turns.

*Guidance:*

- 05 *When indicated by the application of engineering practices, the yellow change interval should be followed by a red clearance interval to provide additional time before conflicting traffic movements, including pedestrians, are released.*

**Standard:**

- 06 **When used, the duration of the red clearance interval shall be determined using engineering practices.**

## Support:

- 07 Engineering practices for determining the duration of yellow change and red clearance intervals can be found in ITE's "Traffic Control Devices Handbook", in ITE's "Manual of Traffic Signal Design" (see [Section 1A.11 of this Supplement](#)).

*Guidance:*

- 08 *Clearance intervals should be calculated using guidance in the latest edition of VDOT's Traffic Engineering Memo TE-306 (with the approved Addendum to TE-306 for the Northern Virginia District) (with the approved Northern Region Traffic Engineering Practice document 406.1 "Yellow Change and Red Clearance Intervals for the Northern Virginia District").\* A link to ~~TE-306~~ all TE Memoranda\* is provided in Appendix A of this Supplement.*

**Standard:**

- 09 **The durations of yellow change intervals and red clearance intervals shall be consistent with the determined values within the technical capabilities of the controller unit.**
- 10 **The duration of a yellow change interval shall not vary on a cycle-by-cycle basis within the same signal timing plan.**
- 11 **Except as provided in Paragraph 13, the duration of a red clearance interval shall not be decreased or omitted on a cycle-by-cycle basis within the same signal timing plan.**

## Option:

- 12 The duration of a red clearance interval may be extended from its predetermined value for a given cycle based upon the detection of a vehicle that is predicted to violate the red signal indication.
- 13 When an actuated signal sequence includes a signal phase for permissive/protected (lagging) left-turn movements in both directions, the red clearance interval may be shown during those cycles when the lagging left-turn signal phase is skipped and may be omitted during those cycles when the lagging left-turn signal phase is shown.
- 14 The duration of a yellow change interval or a red clearance interval may be different in different signal timing plans for the same controller unit.

*Guidance:*

- 15 *A yellow change interval should have a minimum duration of 3 seconds and a maximum duration of 6 seconds. The longer intervals should be reserved for use on approaches with higher speeds.*



- 16 *Except when clearing a one-lane, two-way facility (see [Section 4H.02 of the MUTCD](#)) or when clearing an exceptionally wide intersection, a red clearance interval should have a duration not exceeding 6 seconds.*

**Standard:**

- 17 **Except for warning beacons mounted on advance warning signs on the approach to a signalized location (see [Section 2C.36 of the MUTCD](#)), signal displays that are intended to provide a "pre-yellow warning" interval, such as flashing green signal indications, vehicular countdown displays, or other similar displays, shall not be used at a signalized location.**

**Support:**

- 18 The use of signal displays (other than warning beacons mounted on advance warning signs) that convey a "pre-yellow warning" have been found by research to increase the frequency of crashes.

## **Section 4D.28 Flashing Operation of Traffic Control Signals – General**

**Standard:**

- 01 **The light source of a flashing signal indication shall be flashed continuously at a rate of not less than 50 or more than 60 times per minute.**
- 02 **The displayed period of each flash shall be a minimum of 1/2 and a maximum of 2/3 of the total flash cycle.**
- 03 **Flashing signal indications shall comply with the requirements of other Sections of ~~this Manual~~ **(The text was changed to correspond to include the Supplement and the MUTCD.) the MUTCD and this Supplement\*** regarding visibility-limiting or positioning of conflicting signal indications, except that flashing yellow signal indications for through traffic shall not be required to be visibility-limited or positioned to minimize visual conflict for road users in separately controlled turn lanes.**
- 04 **Each traffic control signal shall be provided with an independent flasher mechanism that operates in compliance with this Section.**
- 05 **The flashing operation shall not be terminated by removal or turn off of the controller unit or of the conflict monitor (malfunction management unit) or both.**
- 06 **A manual switch, a conflict monitor (malfunction management unit) circuit, and, if appropriate, automatic means shall be provided to initiate the flashing mode.**

**Option:**

- 07 Based on engineering study or engineering judgment, traffic control signals may be operated in the flashing mode on a scheduled basis during one or more periods of the day rather than operated continuously in the steady (stop-and-go) mode.

**Support:**

- 08 Section 4E.06 of the MUTCD and Section 4E.09 of this Supplement contain information regarding the operation of pedestrian signal heads and accessible pedestrian signal detector pushbutton locator tones, respectively, during flashing operation.

**Option:**

- 09 Flashing of traffic signals during periods of low volumes in lieu of normal stop-and-go operations may be considered at non-actuated (fixed time) traffic signal installations as a method to reduce delay times during late night periods.

**Standard:**

- 10 **if used for this purpose, the following conditions shall be met:**
- A. Configuration of the intersection shall be a 4 leg or T intersection.
  - B. Motorists on the minor street(s) shall have an unrestricted view of approaching major street traffic.
  - C. Volumes on the major street shall be less than 200 vph for both directions combined during time periods for flashing operation.
  - D. Ratio of major street to minor street hourly traffic volumes shall be equal to or greater than 3:1 during time periods for flashing operation. No arterial-to-arterial roadway intersections shall be operated in the flashing mode.
- 11 **Planned/scheduled flashing operations shall not occur at actuated (semi and fully) traffic signal installations.**

**Support:**

- 12 Late night periods are considered to be one hour after the closing times of nighttime establishments in the area until one hour prior to the morning peak hour.
- 13 While flashing during low volume times might reduce delay times, angle accident potential increases during those times.

**Standard:**

- 14 **Any non-actuated traffic signal installations which utilize a flashing condition during late night periods of low volumes shall have the volume and accident data monitored yearly to determine if it would be beneficial to place the signal in full-color operation during all or part of the flashing period.**
- 15 **Changing a late night flashing operation back to full-color operation based on accident data shall be considered when any of the following conditions are observed:**
- A. 3 right angle accidents a year during periods of flashing operation.
  - B. 2 right angle accidents per million vehicles entering during periods of flashing operation.
  - C. Severity of the accidents increase during periods of flashing operation.





## **Section 4D.V1 Traffic Control Signal Housing Color**

### **Standard:**

- 01 **The color of traffic control signal and beacon housings maintained by VDOT shall be Federal Yellow, except for emergency traffic signals, for which the color of the housing shall be red.**



## CHAPTER 4E. PEDESTRIAN CONTROL FEATURES

### Section 4E.09 Accessible Pedestrian Signals and Detectors – General

#### Support:

- 01 Accessible pedestrian signals and detectors provide information in non-visual formats (such as audible tones, speech messages, and/or vibrating surfaces).
- 02 The primary technique that pedestrians who have visual disabilities use to cross streets at signalized locations is to initiate their crossing when they hear the traffic in front of them stop and the traffic alongside them begin to move, which often corresponds to the onset of the green interval. The existing environment is often not sufficient to provide the information that pedestrians who have visual disabilities need to cross a roadway at a signalized location.
- 03 Additional information relating to accessible pedestrian signals can be found in a report by the Virginia Center for Transportation Innovation and Research called, “Guidelines for the Retrofit Installation of Accessible Pedestrian Signals by the Virginia Department of Transportation.”

#### Standard:

- 04 **If a particular signalized location presents difficulties for pedestrians who have visual disabilities to cross the roadway, an engineering study shall be conducted that evaluates the needs of pedestrians in general, as well as the information needs of pedestrians with visual disabilities. The engineering study shall evaluate the following factors:**
  - A. Potential demand for accessible pedestrian signals;
  - B. A request for accessible pedestrian signals;
  - C. Traffic volumes during times when pedestrians might be present, including periods of low traffic volumes or high turn-on-red volumes;
  - D. The complexity of traffic signal phasing (such as split phases, protected turn phases, leading pedestrian intervals, and exclusive pedestrian phases); and
  - E. The complexity of intersection geometry.

#### Guidance:

- 05 *Once a request is received for an accessible pedestrian signal and it is determined that the intersection meets the basic requirements and needs to be evaluated, an evaluation team should be assembled to visit the intersection and conduct the evaluation described in Paragraphs 8 and 9 in order to derive a priority score. This evaluation should be conducted within one month of the date the written request was received.*
- 06 *Team members should include the requesting blind or visually impaired person, an orientation and mobility specialist (possibly from the Virginia Department of Blind and*



*Visually Impaired), a representative from the local city, town, or county and the VDOT Regional Traffic Engineer or designated representative.*

Option:

- 07 The requesting blind or visually impaired individual may, at his or her discretion, invite others to participate in the evaluation as a member of the evaluation team.

*Guidance:*

- 08 *During the intersection visit, members of the evaluation team should discuss all possible solutions to address the crossing needs of the requesting blind or visually impaired person. The conditions shown in Table 4E-V1 in this Supplement should be evaluated:*
- 09 *The VDOT Regional Traffic Engineer should ensure the request for the accessible pedestrian signal is still valid, if a significant amount of time elapses between the intersection's evaluation and the installation of the accessible pedestrian signal.*

Support:

- 10 The factors that make crossing at a signalized location difficult for pedestrians who have visual disabilities include: increasingly quiet cars, right turn on red (which masks the beginning of the through phase), continuous right-turn movements, complex signal operations, traffic circles, and wide streets. Furthermore, low traffic volumes might make it difficult for pedestrians who have visual disabilities to discern signal phase changes.
- 11 Local organizations, providing support services to pedestrians who have visual and/or hearing disabilities, can often act as important advisors to the traffic engineer when consideration is being given to the installation of devices to assist such pedestrians. Additionally, orientation and mobility specialists or similar staff also might be able to provide a wide range of advice. The U.S. Access Board ([www.access-board.gov](http://www.access-board.gov)) provides technical assistance for making pedestrian signal information available to persons with visual disabilities (see Page i for the address for the U.S. Access Board).

**Standard:**

- 12 **When used, accessible pedestrian signals shall be used in combination with pedestrian signal timing. The information provided by an accessible pedestrian signal shall clearly indicate which pedestrian crossing is served by each device.**
- 13 **Under stop-and-go operation, accessible pedestrian signals shall not be limited in operation by the time of day or day of week.**

Option:

- 14 Accessible pedestrian signal detectors may be pushbuttons or passive detection devices.
- 15 At locations with pretimed traffic control signals or non-actuated approaches, pedestrian pushbuttons may be used to activate the accessible pedestrian signals.

Support:

- 16 Accessible pedestrian signals are typically integrated into the pedestrian detector (pushbutton), so the audible tones and/or messages come from the pushbutton housing. They have a pushbutton locator tone and tactile arrow, and can include audible beaconing and other special features.



## Table 4E-V1 Accessible Pedestrian Signal Evaluation Factors

Evaluation Factor	Brief Description
1. Configuration of Intersection	Skewed, offset, lacking particular straight through movements
2. Width of Crossing	Width of approach used by requesting party
3. Maximum Posted Speed Limit on Street to Be Crossed	Maximum posted speed limit on street to be used by requesting party
4. Special Traffic Conditions I	Heavy right-turn volumes and right-turn signals or arrows
5. Special Traffic Conditions II	Free flow right-turn lane (with or without a right-turn island)
6. Special Pedestrian Signal Conditions	Lead or exclusive pedestrian phases, mid-block exclusive pedestrian signals
7. Proximity of Intersection to Key Facilities	Distance to pedestrian generators or attractors
8. Need to Cross by Visually Impaired	Work- or school-related trip purpose by requesting party
9. Other Special Traffic and Mobility Conditions	Catchall to account for other concerns, especially if low volumes are a problem

### Option:

- 17 The name of the street to be crossed may also be provided in accessible format, such as Braille or raised print. Tactile maps of crosswalks may also be provided.

### Support:

- 18 Specifications regarding the use of Braille or raised print for traffic control devices can be found in the "Americans with Disabilities Act Accessibility Guidelines for Buildings and Facilities (ADAAG)" (see [Section 1A.11 of this Supplement](#)).

### Standard:

- 19 **At accessible pedestrian signal locations where pedestrian pushbuttons are used, each pushbutton shall activate both the walk interval and the accessible pedestrian signals.**

## **Section 4E.11 Accessible Pedestrian Signals and Detectors – Walk Indications**

### Support:

- 01 Technology that provides different sounds for each non-concurrent signal phase has frequently been found to provide ambiguous information. Research indicates that a rapid tick tone for each crossing coming from accessible pedestrian signal devices on separated poles located close to each crosswalk provides unambiguous information to pedestrians who are blind or visually impaired. Vibrotactile indications provide information to pedestrians who are blind and deaf and are also used by pedestrians who are blind or who have low vision to confirm the walk signal in noisy situations.

### Standard:

- 02 **Accessible pedestrian signals shall have both audible and vibrotactile walk indications.**

03 **Vibrotactile walk indications shall be provided by a tactile arrow on the pushbutton (see Section 4E.12 of this Supplement) that vibrates during the walk interval.**

04 **Accessible pedestrian signals shall have an audible walk indication during the walk interval only. The audible walk indication shall be audible from the beginning of the associated crosswalk.**



05 **The walk interval tone shall be a percussive tone similar to the locator tone (Section 4E.12 of this Supplement) except repeat at a faster rate. Specifically, the duration of the tone shall repeat 8 to 10 times per second. Walk interval tones shall consist of multiple frequencies with a dominant component of 880 Hz.**

06 **The accessible walk indication shall have the same duration as the pedestrian walk signal except when the pedestrian signal rests in walk.**

*Guidance:*

07 *If the pedestrian signal rests in walk, the accessible walk indication should be limited to the first 7 seconds of the walk interval. The accessible walk indication should be recalled by a button press during the walk interval provided that the crossing time remaining is greater than the pedestrian change interval.*

**Standard:**

08 **Where two accessible pedestrian signals are separated by a distance of at least 10 feet, the audible walk indication shall be a percussive tone. Where two accessible pedestrian signals on one corner are not separated by a distance of at least 10 feet, the audible walk indication shall be a speech walk message.**

09 **Audible tone walk indications shall repeat at eight to ten ticks per second. Audible tones used as walk indications shall consist of multiple frequencies with a dominant component at 880 Hz.**

*Guidance:*

10 *The volume of audible walk indications and pushbutton locator tones (see Section 4E.12 of this Supplement) should be set to be a maximum of 5 dBA louder than ambient sound, except when audible beaconing is provided in response to an extended pushbutton press.*

**Standard:**



11 **The automatic volume adjustment in response to ambient traffic sound level shall be 2 dBA minimum and 5 dBA maximum above ambient noise level and shall provide up to a maximum volume of 100 dBA.**

*Guidance:*

12 *The sound level of audible walk indications and pushbutton locator tones should be adjusted to be low enough to avoid misleading pedestrians who have visual disabilities when the following conditions exist:*

- A. *Where there is an island that allows unsignalized right turns across a crosswalk between the island and the sidewalk.*
- B. *Where multi-leg approaches or complex signal phasing require more than two pedestrian phases, such that it might be unclear which crosswalk is served by each audible tone.*

*C. At intersections where a diagonal pedestrian crossing is allowed, or where one street receives a WALKING PERSON (symbolizing WALK) signal indication simultaneously with another street.*

**Option:**

- 13 An alert tone, which is a very brief burst of high-frequency sound at the beginning of the audible walk indication that rapidly decays to the frequency of the walk tone, may be used to alert pedestrians to the beginning of the walk interval.

**Support:**

- 14 An alert tone can be particularly useful if the walk tone is not easily audible in some traffic conditions.
- 15 Speech walk messages communicate to pedestrians which street has the walk interval. Speech messages might be either directly audible or transmitted, requiring a personal receiver to hear the message. To be a useful system, the words and their meaning need to be correctly understood by all users in the context of the street environment where they are used. Because of this, tones are the preferred means of providing audible walk indications except where two accessible pedestrian signals on one corner are not separated by a distance of at least 10 feet.
- 16 If speech walk messages are used, pedestrians have to know the names of the streets that they are crossing in order for the speech walk messages to be unambiguous. In getting directions to travel to a new location, pedestrians with visual disabilities do not always get the name of each street to be crossed. Therefore, it is desirable to give users of accessible pedestrian signals the name of the street controlled by the pushbutton. This can be done by means of a speech pushbutton information message (see [Section 4D.13 of the MUTCD](#)) during the flashing or steady UPRAISED HAND intervals, or by raised print and Braille labels on the pushbutton housing.
- 17 By combining the information from the pushbutton message or Braille label, the tactile arrow aligned in the direction of travel on the relevant crosswalk, and the speech walk message, pedestrians with visual disabilities are able to correctly respond to speech walk messages even if there are two pushbuttons on the same pole.

**Standard:**

- 18 **If speech walk messages are used to communicate the walk interval, they shall provide a clear message that the walk interval is in effect, as well as to which crossing it applies. Speech walk messages shall be used only at intersections where it is technically infeasible to install two accessible pedestrian signals at one corner separated by a distance of at least 10 feet.**
- 19 **Speech walk messages that are used at intersections having pedestrian phasing that is concurrent with vehicular phasing shall be patterned after the model: "Broadway. Walk sign is on to cross Broadway."**
- 20 **Speech walk messages that are used at intersections having exclusive pedestrian phasing shall be patterned after the model: "Walk sign is on for all crossings."**

- 21 **Speech walk messages shall not contain any additional information, except they shall include designations such as "Street" or "Avenue" where this information is necessary to avoid ambiguity at a particular location.**

*Guidance:*

- 22 *Speech walk messages should not state or imply a command to the pedestrian, such as "Cross Broadway now." Speech walk messages should not tell pedestrians that it is "safe to cross," because it is always the pedestrian's responsibility to check actual traffic conditions.*

**Standard:**

- 23 **A speech walk message is not required at times when the walk interval is not timing, but, if provided:**
- A. **It shall begin with the term "wait."**
  - B. **It need not be repeated for the entire time that the walk interval is not timing.**
- 24 **If a pilot light (see [Section 4E.08 of the MUTCD](#)) is used at an accessible pedestrian signal location, each actuation shall be accompanied by the speech message "wait."**

*Option:*

- 25 Accessible pedestrian signals that provide speech walk messages may provide similar messages in languages other than English, if needed, except for the terms "walk sign" and "wait."

**Standard:**

- 26 **Following the audible walk indication, accessible pedestrian signals shall revert to the pushbutton locator tone (see [Section 4E.12 of this Supplement](#)) during the pedestrian change interval.**

## **Section 4E.12 Accessible Pedestrian Signals and Detectors – Tactile Arrows and Locator Tones**

**Standard:**

- 01 **To enable pedestrians who have visual disabilities to distinguish and locate the appropriate pushbutton at an accessible pedestrian signal location, pushbuttons shall clearly indicate by means of tactile arrows which crosswalk signal is actuated by each pushbutton. Tactile arrows shall be located on the pushbutton, have high visual contrast (light on dark or dark on light), and shall be aligned parallel to the direction of travel on the associated crosswalk.**

- 02 **An accessible pedestrian pushbutton shall incorporate a locator tone.**

*Support:*

- 03 **A pushbutton locator tone is a repeating sound that informs approaching pedestrians that a pushbutton to actuate pedestrian timing or receive additional information exists, and that enables pedestrians with visual disabilities to locate the pushbutton.**

**Standard:**

- 04 **Pushbutton locator tones shall be a percussive tone similar to the interval tone (see Section 4E.11 of this Supplement) except that it shall be at a slower rate and have a duration of 0.15 seconds or less, and shall repeat at 1-second intervals. Locator tones shall consist of multiple frequencies with a dominant component at 880 Hz.**
- 05 **Pushbutton locator tones shall be deactivated when the traffic control signal is operating in a flashing mode. This requirement shall not apply to traffic control signals or pedestrian hybrid beacons that are activated from a flashing or dark mode to a stop-and-go mode by pedestrian actuations.**
- 06 **Pushbutton locator tones shall have automatic volume adjustment in response to ambient traffic sound levels. The tones shall be 2 dBA minimum and 5 dBA maximum above ambient noise level and shall provide up to a maximum volume of 100 dBA. The tone shall be audible 6 to 12 feet from the pushbutton, or to the building line, whichever is less.**
- 07 **Pedestrian activation tones shall be a beep, tick, or other percussive tone and begin immediately following the initial button press to confirm that pedestrian signal timing has been activated.**



- Support:
- 08 **Section 4E.11 of this Supplement contains additional provisions regarding the volume and sound level of pushbutton locator tones.**

# CHAPTER 4J. TRAFFIC CONTROL FOR MOVABLE BRIDGES

## Section 4J.02 Design and Location of Movable Bridge Signals and Gates

### Standard:

- 01 The signal faces and mountings of movable bridge signals shall comply with the provisions of Chapter 4D except as provided in this Section.
- 02 Signal faces with 12-inch diameter signal indications shall be used for all new movable bridge signals.

### Option:

- 03 Existing signal faces with 8-inch diameter lenses may be retained for the remainder of their useful service life.

### Standard:

- 04 Since movable bridge operations cover a variable range of time periods between openings, the signal faces shall be one of the following types:
  - A. Three-section signal faces with red, yellow, and green signal indications; or
  - B. Two one-section signal faces with red signal indications in a vertical array separated by a STOP HERE ON RED (R10-6) sign (see [Section 2B.53 of this Supplement](#)).
- 05 Regardless of which signal type is selected, at least two signal faces shall be provided for each approach to the movable span and a stop line (see [Section 3B.16 of this Supplement](#)) shall be installed to indicate the point behind which vehicles are required to stop.

### Guidance:

- 06 *If movable bridge operation is frequent, the use of three-section signal faces should be considered.*
- 07 *Insofar as practical, the height and lateral placement of signal faces should comply with the requirements for other traffic control signals in accordance with Chapter 4D. They should be located no more than 50 feet in advance of the movable bridge warning gate.*

### Option:

- 08 Movable bridge signals may be supplemented with audible warning devices to provide additional warning to drivers and pedestrians.

### Standard:

- 09 A DRAW BRIDGE (W3-6) sign (see [Section 2C.39 of the MUTCD](#)) shall be used in advance of movable bridge signals and gates to give warning to road users, except in urban conditions where such signing would not be practical.





10 **If physical conditions prevent a road user from having a continuous view of at least two signal indications for the distance specified in Table 4D-2, an auxiliary device (either a supplemental signal face or the mandatory DRAW BRIDGE (W3-6) sign to which has been added a warning beacon that is interconnected with the movable bridge controller unit) shall be provided in advance of movable bridge signals and gates.**

11 **A BE PREPARED TO STOP (W3-4) sign (see Section 2C.36 of the MUTCD) and WHEN FLASHING (W16-13P) plaque shall be used in advance of movable bridge signals and gates to give warning to road users, except in urban conditions where such signing would not be practical. When used, the BE PREPARED TO STOP sign and WHEN FLASHING plaque shall be supplemented by a crossing bell and two Warning Beacons (see Section 4L.03 of the MUTCD).**

Option:

12 The DRAW BRIDGE (W3-6) sign may be supplemented by a Warning Beacon (see [Section 4L.03 of the MUTCD](#)).

**Standard:**

13 **If two sets of gates (both a warning and a resistance gate) are used for a single direction, highway traffic signals shall not be required to accompany the resistance gate nearest the span opening.**

14 **Movable bridge warning gates, if used, shall be at least standard railroad size, striped with 16-inch alternate vertical, fully reflectorized red and white stripes. Flashing red lights in accordance with the Standards for those on railroad gates (see [Section 8C.04 of the MUTCD](#)) shall be included on the gate arm and they shall only be operated if the gate is closed or in the process of being opened or closed. In the horizontal position, the top of the gate shall be approximately 4 feet above the pavement.**

*Guidance:*

15 *Movable bridge warning gates should be of lightweight construction. In its normal upright position, the gate arm should provide adequate lateral clearance.*

Option:

16 The movable bridge resistance gates may be delineated, if practical, in a manner similar to the movable bridge warning gate.

**Standard:**

17 **Movable bridge warning gates, if used, shall extend at least across the full width of the approach lanes if movable bridge resistance gates are used. On divided highways in which the roadways are separated by a barrier median, movable bridge warning gates, if used, shall extend across all roadway lanes approaching the span openings.**

*Guidance:*

18 *If movable bridge resistance gates are not used on undivided highways, movable bridge warning gates, if used, should extend across the full width of the roadway.*

Option:

19 A single full-width gate or two half-width gates may be used.

**Support:**

- 20 The locations of movable bridge signals and gates are determined by the location of the movable bridge resistance gate (if used) rather than by the location of the movable spans. The movable bridge resistance gates for high-speed highways are preferably located 50 feet or more from the span opening except for bascule and lift bridges, where they are often attached to, or are a part of, the structure.

**Standard:**

- 21 **Except where physical conditions make it impractical, movable bridge warning gates shall be located 100 feet or more from the movable bridge resistance gates or, if movable bridge resistance gates are not used, 100 feet or more from the movable span.**

*Guidance:*

- 22 *On bridges or causeways that cross a long reach of water and that might be hit by large marine vessels, within the limits of practicality, traffic should not be halted on a section of the bridge or causeway that is subject to impact.*
- 23 *In cases where it is not practical to halt traffic on a span that is not subject to impact, traffic should be halted at least one span from the opening. If traffic is halted by signals and gates more than 330 feet from the movable bridge warning gates (or from the span opening if movable bridge warning gates are not used), a second set of gates should be installed approximately 100 feet from the gate or span opening.*
- 24 *If the movable bridge is close to a grade crossing and traffic might possibly be stopped on the crossing as a result of the bridge opening, a traffic control device should notify the road users to not stop on the railroad tracks.*

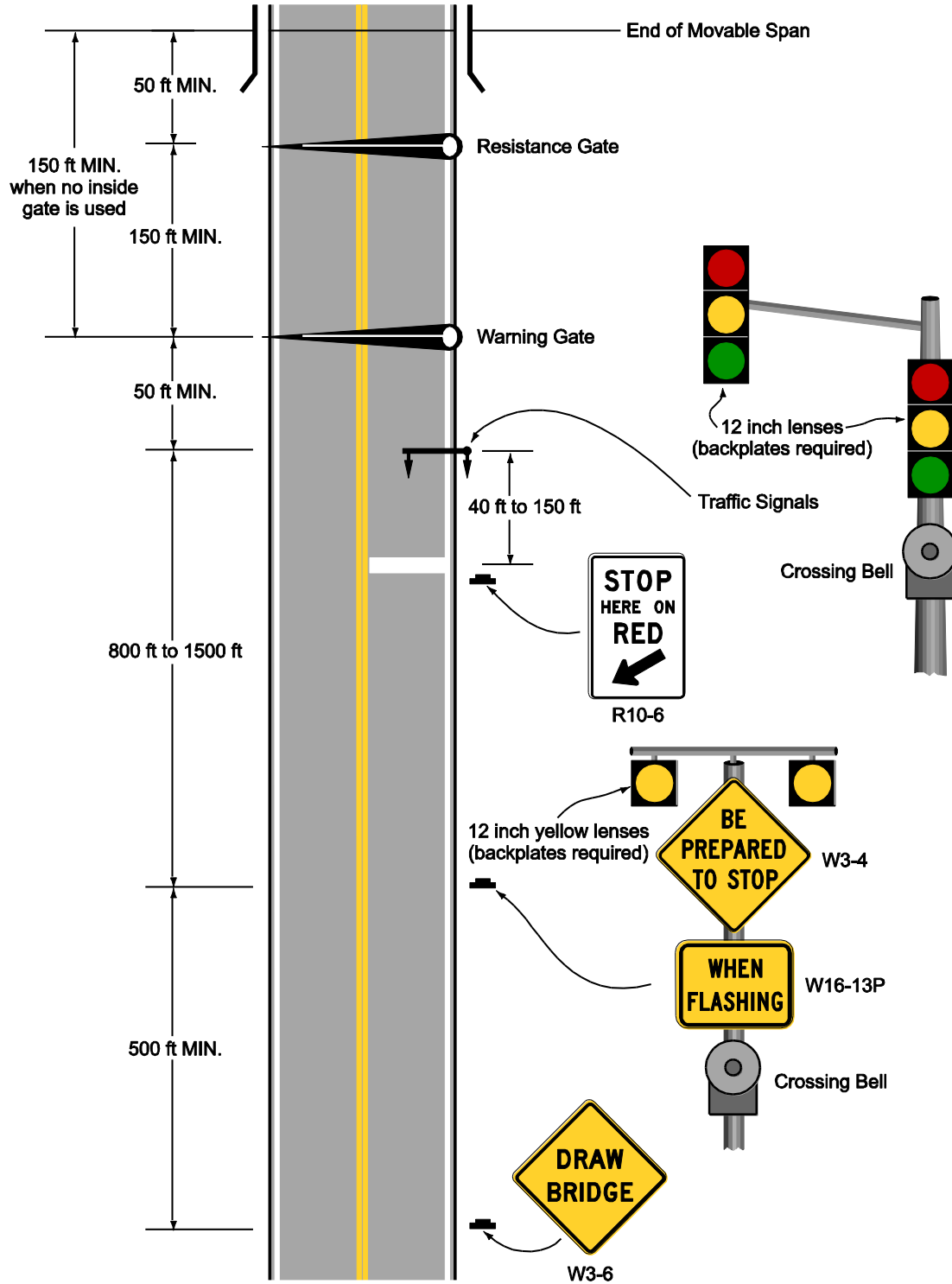
**Support:**

- 25 [Figure 4J-V1 in this Supplement provides drawbridge protection details for undivided roadways.](#)





### Figure 4J-V1. Typical Drawbridge Protection Details Undivided Roadway



## CHAPTER 4N. IN-ROADWAY LIGHTS

### Section 4N.01 Application of In-Roadway Lights

Support:

- 01 In-Roadway Lights are special types of highway traffic signals installed in the roadway surface to warn road users that they are approaching a condition on or adjacent to the roadway that might not be readily apparent and might require the road users to slow down and/or come to a stop. This includes situations warning of marked school crosswalks, marked midblock crosswalks, marked crosswalks on uncontrolled approaches, marked crosswalks in advance of roundabouts as described in Chapter 3C, and other roadway situations involving pedestrian crossings.

**Standard:**

- 02 **In-Roadway Lights shall not be used for any application that is not described in this Chapter.**
- 03 **If used, In-Roadway Lights shall not exceed a height of 3/4 inch above the roadway surface.**
- 04 **When used, In-Roadway Lights shall be flashed and shall not be steadily illuminated.**

Support:

- 05 Steadily illuminated lights installed in the roadway surface are considered to be internally illuminated raised pavement markers (see [Section 3B.11 of this Supplement](#)).

Option:

- 06 In-Roadway Lights may be flashed in a manner that includes a continuous flash of varying intensity and time duration that is repeated to provide a flickering effect (see [Section 4N.02 of this Supplement](#)).

Support:

- 07 [In-Roadway Lights and guidelines for their installation are discussed in the VDOT document Guidelines for the Installation of In-Roadway Warning Lights. A link to this document can be found in Appendix A of this Supplement.](#)



### Section 4N.02 In-Roadway Warning Lights at Crosswalks

Option:

- 01 In-roadway lights may be installed at certain marked crosswalks, based on an engineering study or engineering judgment, to provide additional warning to road users.

*Guidance:*

- 02 *Prior to the installation of in-roadway warning lights at crosswalks, other countermeasures should be carefully considered.*



**Standard:**

- 03 **If used, In-Roadway Warning Lights at crosswalks shall be installed only at marked crosswalks with applicable warning signs. They shall not be used at crosswalks controlled by YIELD signs, STOP signs, or traffic control signals.**
- 04 **If In-Roadway Warning Lights are used at a crosswalk, the following requirements shall apply:**
- A. **Except as provided in Paragraphs 9 and 10, they shall be installed along both sides of the crosswalk and shall span its entire length.**
  - B. **They shall initiate operation based on pedestrian actuation and shall cease operation at a predetermined time after the pedestrian actuation or, with passive detection, after the pedestrian clears the crosswalk.**
  - C. **They shall display a flashing yellow light when actuated. The flash rate shall be at least 50, but no more than 60, flash periods per minute. If they are flashed in a manner that includes a continuous flash of varying intensity and time duration that is repeated to provide a flickering effect, the flickers or pulses shall not repeat at a rate that is between 5 and 30 per second to avoid frequencies that might cause seizures.**
  - D. **They shall be installed in the area between the outside edge of the crosswalk line and 10 feet from the outside edge of the crosswalk.**
  - E. **They shall face away from the crosswalk if unidirectional, or shall face away from and across the crosswalk if bidirectional.**
- 05 **If used on one-lane, one-way roadways, a minimum of two In-Roadway Warning Lights shall be installed on the approach side of the crosswalk. If used on two-lane roadways, a minimum of three In-Roadway Warning Lights shall be installed along both sides of the crosswalk. If used on roadways with more than two lanes, a minimum of one In-Roadway Warning Light per lane shall be installed along both sides of the crosswalk.**

*Guidance:*

- 06 *If used, In-Roadway Warning Lights should be installed in the center of each travel lane, at the center line of the roadway, at each edge of the roadway or parking lanes, or at other suitable locations away from the normal tire track paths.*
- 07 *The location of the In-Roadway Warning Lights within the lanes should be based on engineering judgment.*

*Option:*

- 08 On one-way streets, In-Roadway Warning Lights may be omitted on the departure side of the crosswalk.
- 09 Based on engineering judgment, the In-Roadway Warning Lights on the departure side of the crosswalk on the left side of a median may be omitted.
- 10 Unidirectional In-Roadway Warning Lights installed at crosswalk locations may have an optional, additional yellow light indication in each unit that is visible to pedestrians in the crosswalk to indicate to pedestrians in the crosswalk that the In-Roadway Warning

Lights are in fact flashing as they cross the street. These yellow lights may flash with and at the same flash rate as the light module in which each is installed.

*Guidance:*

- 11 *If used, the period of operation of the In-Roadway Warning Lights following each actuation should be sufficient to allow a pedestrian crossing in the crosswalk to leave the curb or shoulder and travel at a walking speed of 3.5 feet per second to at least the far side of the traveled way or to a median of sufficient width for pedestrians to wait. Where pedestrians who walk slower than 3.5 feet per second, or pedestrians who use wheelchairs, routinely use the crosswalk, a walking speed of less than 3.5 feet per second should be considered in determining the period of operation.*

**Standard:**

- 12 **If pedestrian pushbuttons are used to actuate the in-roadway lights, a Push Button To Turn On Warning Lights (with pushbutton symbol) (R10-25) sign (see Figure 2B-26) shall be mounted adjacent to or integral with each pedestrian pushbutton.**
- 13 **Where the period of operation is sufficient only for crossing from a curb or shoulder to a median of sufficient width for pedestrians to wait, median-mounted pedestrian actuators shall be provided.**

## **PART 7. TRAFFIC CONTROL FOR SCHOOL AREAS**

### **CHAPTER 7A. GENERAL** **PAGE**

Section 7A.01	Need for Standards	
Section 7A.02	School Routes and Established School Crossings	
Section 7A.03	School Crossing Control Criteria	
Section 7A.04	Scope	

### **CHAPTER 7B. SIGNS** **PAGE**

Section 7B.01	Size of School Signs	
Section 7B.02	Illumination and Reflectorization.....	7-1
Section 7B.03	Position of Signs	
Section 7B.04	Height of Signs	
Section 7B.05	Installation of Signs	
Section 7B.06	Lettering	
Section 7B.07	Sign Color for School Warning Signs	
Section 7B.08	School Sign (S1-1) and Plaques	
Section 7B.09	School Zone Sign (S1-1) and Plaques (S4-3P, S4-7P) and END SCHOOL ZONE Sign (S5-2)	
Section 7B.10	Higher Fines Zone Signs (R2-10, R2-11) and Plaques	
Section 7B.11	School Advance Crossing Assembly .....	7-1
Section 7B.12	School Crossing Assembly .....	7-6
Section 7B.13	School Bus Stop Ahead Sign (S3-1)	
Section 7B.14	SCHOOL BUS TURN AHEAD Sign (S3-2)	
Section 7B.15	School Speed Limit Assembly (S4-1P, S4-2P, S4-3P, S4-4P, S4-6P, S5-1) and END SCHOOL SPEED LIMIT Sign (S5-3)	
Section 7B.16	Reduced School Speed Limit Ahead Sign (S4-5, S4-5a).....	7-8
Section 7B.17	Parking and Stopping Signs (R7 and R8 Series) .....	7-9

### **CHAPTER 7C. MARKINGS** **PAGE**

Section 7C.01	Functions and Limitations	
Section 7C.02	Crosswalk Markings	
Section 7C.03	Pavement Word, Symbol, and Arrow Markings	

### **CHAPTER 7D. CROSSING SUPERVISION** **PAGE**

Section 7D.01	Types of Crossing Supervision	
Section 7D.02	Adult Crossing Guards	
Section 7D.03	Qualifications of Adult Crossing Guards	

Section 7D.04 Uniform of Adult Crossing Guards

Section 7D.05 Operating Procedures for Adult Crossing Guards



# PART 7

## TRAFFIC CONTROL FOR SCHOOL AREAS

### CHAPTER 7B. SIGNS

#### Section 7B.01 Size of School Signs

**Standard:**

- 01 Except as provided in [Section 2A.11 of this Supplement](#), the sizes of signs and plaques to be used on conventional roadways in school areas shall be as shown in [Table 7B-1\(VA\) in this Supplement](#).
- 02 The sizes in the Conventional Road column shall be used unless engineering judgment determines that a minimum or oversized sign size would be more appropriate.
- 03 The sizes in the Minimum column shall be used only where traffic volumes are low and speeds are 30 mph or lower, as determined by engineering judgment.
- 04 The sizes in the Oversized column shall be used on expressways.

*Guidance:*

- 05 *The sizes in the Oversized column should be used on roadways that have four or more lanes with posted speed limits of 40 mph or higher.*

**Option:**

- 06 The sizes in the Oversized column may also be used at other locations that require increased emphasis, improved recognition, or increased legibility.
- 07 Signs and plaques larger than those shown in [Table 7B-1\(VA\) in this Supplement](#) may be used (see [Section 2A.11 of this Supplement](#)).


#### Section 7B.11 School Advance Crossing Assembly

**Standard:**

- 01 The School Advance Crossing assembly (see [Figure 7B-1\(VA\) in this Supplement](#)) shall consist of a School (S1-1) sign supplemented with an AHEAD (W16-9P) plaque or an XX FEET (W16-2P or W16-2aP) plaque.
- 02 Except as provided in Paragraph 3, a School Advance Crossing assembly shall be used in advance (see Table 2C-4 for advance placement guidelines) of the first School Crossing assembly (see [Section 7B.12 of this Supplement](#)) that is encountered in each direction as traffic approaches a school crosswalk (see Figure 7B-4).

**Table 7B-1 (VA). School Area Sign and Plaque Sizes**

Sign	Sign Designation	Section	Conventional Road	Minimum	Oversized
School	S1-1	7B.08	36 x 36	30 x 30	48 x 48
School Bus Stop Ahead	S3-1	7B.13	36 x 36	30 x 30	48 x 48
School Bus Turn Ahead	S3-2	7B.14	36 x 36	30 x 30	48 x 48
Reduced School Speed Limit Ahead	S4-5, <del>S4-5a</del>	7B.16	36 x 36	30 x 30	48 x 48
School Speed Limit XX When Flashing	S5-1	7B.15	24 x 48	—	36 x 72
End School Zone	S5-2	7B.09	24 x 30	—	36 x 48
End School Speed Limit	S5-3	7B.15	24 x 30	—	36 x 48
In-Street Ped Crossing	R1-6, <del>R1-6a</del> , R1-6b, <del>R1-6c</del>	7B.11, 7B.12	12 x 36	—	—
Speed Limit (School Use)	R2-1	7B.15	24 x 30	—	36 x 48
Begin Higher Fines Zone	R2-10	7B.10	24 x 30	—	36 x 48
End Higher Fines Zone	R2-11	7B.10	24 x 30	—	36 x 48
X:XX to X:XX AM X:XX to X:XX PM	S4-1P	7B.15	24 x 10	—	36 x 18
When Children Are Present	S4-2P	7B.15	24 x 10	—	36 x 18
School	S4-3P	7B.09, 7B.15	24 x 8	—	36 x 12
When Flashing	S4-4P	7B.15	24 x 10	—	36 x 18
Mon-Fri	S4-6P	7B.15	24 x 10	—	36 x 18
All Year	S4-7P	7B.09	24 x 12	—	30 x 18
Fines Higher	R2-6P	7B.10	24 x 18	—	36 x 24
XX Feet	W16-2P	7B.08	24 x 18	—	30 x 24
XX Ft	W16-2aP	7B.08	24 x 12	—	30 x 18
Turn Arrow	W16-5P	7B.08, 7B.09, 7B.11	24 x 12	—	30 x 18
Advance Turn Arrow	W16-6P	7B.08, 7B.09, 7B.11	24 x 12	—	30 x 18
Diagonal Arrow	W16-7P	7B.12	24 x 12	—	30 x 18

Sign	Sign Designation	Section	Conventional Road	Minimum	Oversized
Diagonal Arrow (optional size)	W16-7P	7B.12	21 x 15	—	—
Ahead	W16-9P	7B.11	24 x 12	—	30 x 18
 <b>Virginia Specific Signs</b>					
STATE LAW STOP FOR SCHOOL BUS LOADING OR UNLOADING CHILDREN	S0-V1	7B.17	48 x 48	—	—

Note: 1. Larger sizes may be used when appropriate  
 2. Dimensions are shown in inches and are shown as width x height  
 3. Minimum sign sizes for multi-lane conventional roads shall be as shown in the Conventional Road column

#### Option:

- 03 The School Advance Crossing assembly may be omitted (see Figure 7B-5) where a School Zone (S1-1) sign (see [Section 7B.09 of the MUTCD](#)) is installed to identify the beginning of a school zone in advance of the School Crossing assembly.
- 04 If a school crosswalk is located on a cross street in close proximity to an intersection, a School Advance Crossing assembly with a supplemental arrow (W16-5P or W16-6P) plaque may be installed on each approach of the street or highway to warn road users making a turn onto the cross street that they will encounter a school crosswalk soon after making the turn.
- 05 A 12-inch reduced size in-street School (S1-1) sign (see [Figure 7B-6\(VA\) in this Supplement](#)), installed in compliance with the mounting height and special mounting support requirements for In-Street Pedestrian Crossing (R1-6) signs (see [Section 2B.12 of this Supplement](#)), may be used in advance of a school crossing to supplement the post-mounted school warning signs. A 12 x 6-inch reduced size AHEAD (W16-9P) plaque may be mounted below the reduced size in-street School (S1-1) sign.

#### Support:

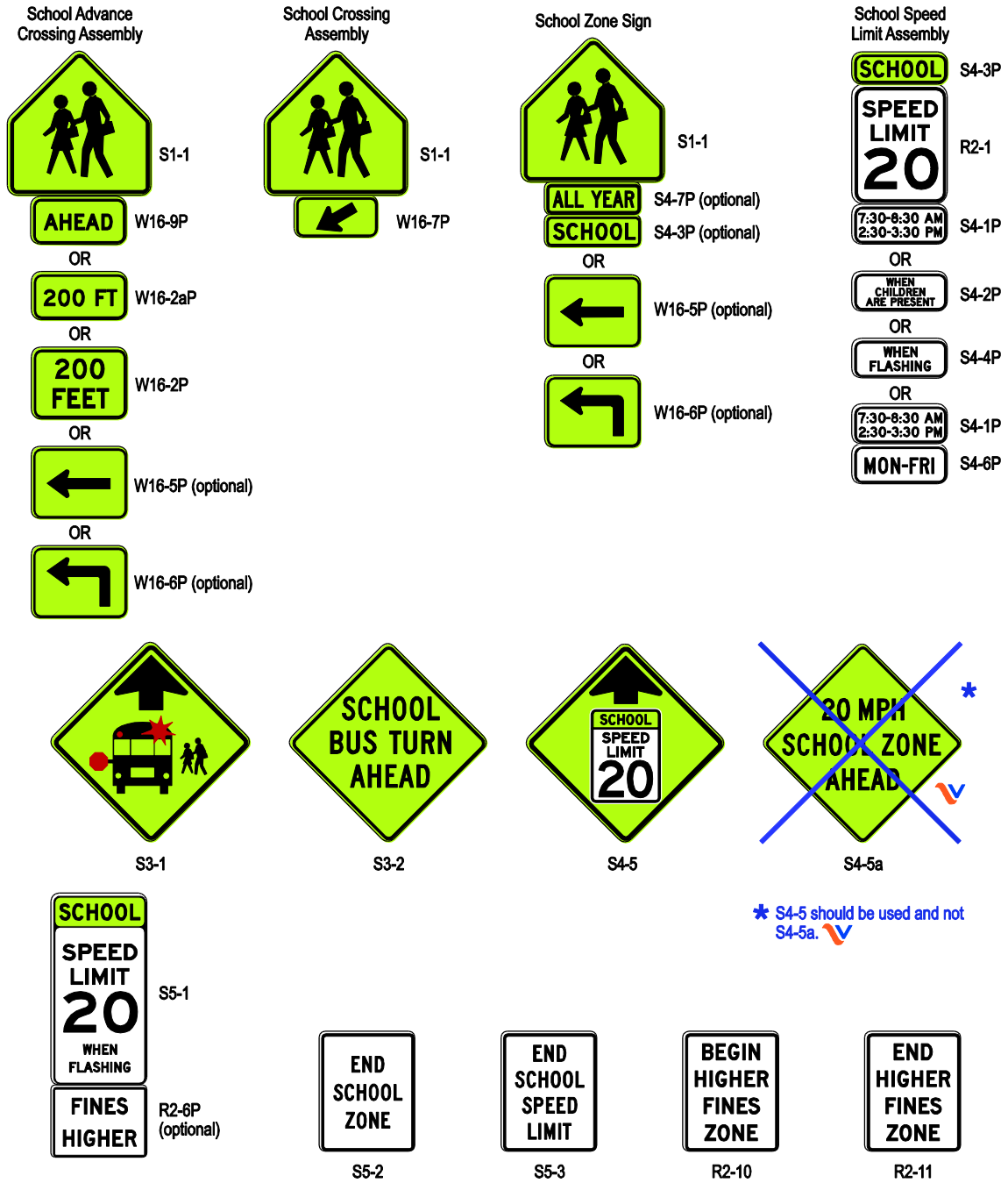
- 06 The Code of Virginia § 46.2-924 requires that drivers at crosswalks yield the right-of-way to pedestrians crossing the highway. The Standard statement in Section 2B.12 of the National MUTCD permits the use of the Stop for Pedestrians (R1-6a and R1-9a) signs only if state law specifically requires the driver to stop for a pedestrian in a crosswalk. As The Code of Virginia does not require a driver to stop, the R1-6a and R1-9a signs cannot be utilized.

#### Standard:

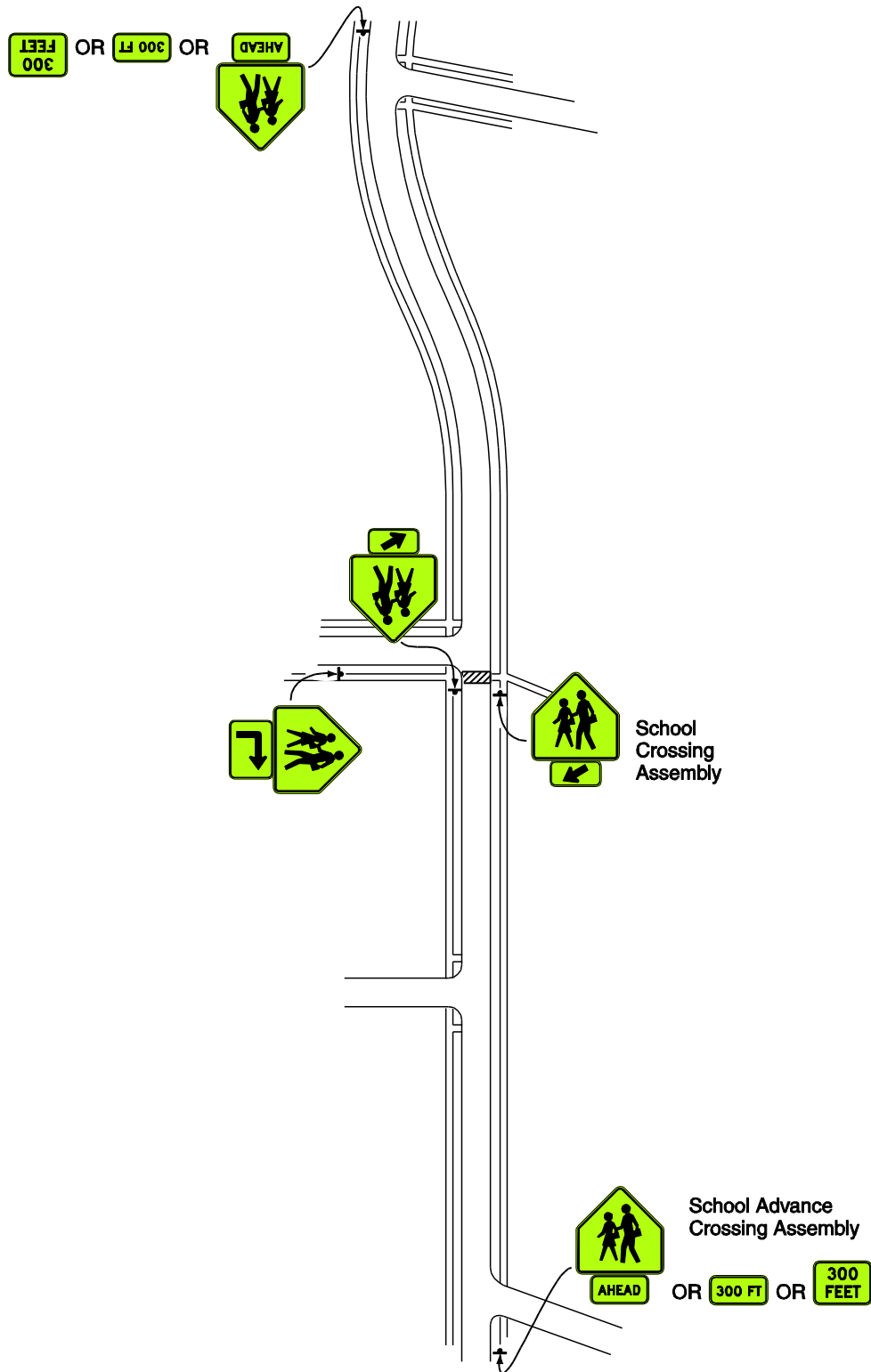
- 07 **The R1-6a In Street Pedestrian Crossing sign shall not be used (see Section 2B.12 of this Supplement).**

- Option:  
 08 If used, the R1-6 In Street Pedestrian Crossing sign may omit the legend STATE LAW (see Section 2B.12 of this Supplement).

**Figure 7B-1(VA). School Area Signs**



### Figure 7B-4. Example of Signing for a School Crossing Outside of a School Zone



## Section 7B.12 School Crossing Assembly

### Standard:

- 01 If used, the School Crossing assembly (see [Figure 7B-1\(VA\) in this Supplement](#)) shall be installed at the school crossing (see [Figures 7B-4 and 7B-5](#)), or as close to it as possible, and shall consist of a School (S1-1) sign supplemented with a diagonal downward pointing arrow (W16-7P) plaque to show the location of the crossing.
- 02 The School Crossing assembly shall not be used at crossings other than those adjacent to schools and those on established school pedestrian routes.
- 03 The School Crossing assembly shall not be installed on approaches controlled by a STOP or YIELD sign.

### Option:

- 04 The In-Street Pedestrian Crossing (R1-6) sign (see [Section 2B.12 of this Supplement](#) and [Figure 7B-6\(VA\) in this Supplement](#)) or the In-Street Schoolchildren Crossing (R1-6b) sign (see [Figure 7B-6\(VA\) in this Supplement](#)) may be used at unsignalized school crossings. If used at a school crossing, a 12 x 4-inch SCHOOL (S4-3P) plaque (see [Figure 7B-6\(VA\) in this Supplement](#)) may be mounted above the sign. The STATE LAW legend on the R1-6 and R1-6b signs may be omitted.

### Support:

- 05 The Code of Virginia § 46.2-924 requires that drivers at crosswalks yield the right-of-way to pedestrians crossing the highway. The Standard statement in Section 2B.12 of the National MUTCD permits the use of the Stop for Pedestrians (R1-6a) sign only if state law specifically requires the driver to stop for a pedestrian in a crosswalk. As the Code of Virginia does not require a driver to stop, the R1-6a, and by extension, R1-6c signs, cannot be utilized.

### Standard:

- 06 **The R1-6a In Street Pedestrian Crossing and R1-6c In-Street Schoolchildren Crossing signs shall not be used (see Section 2B.12 of this Supplement).**

### Option:

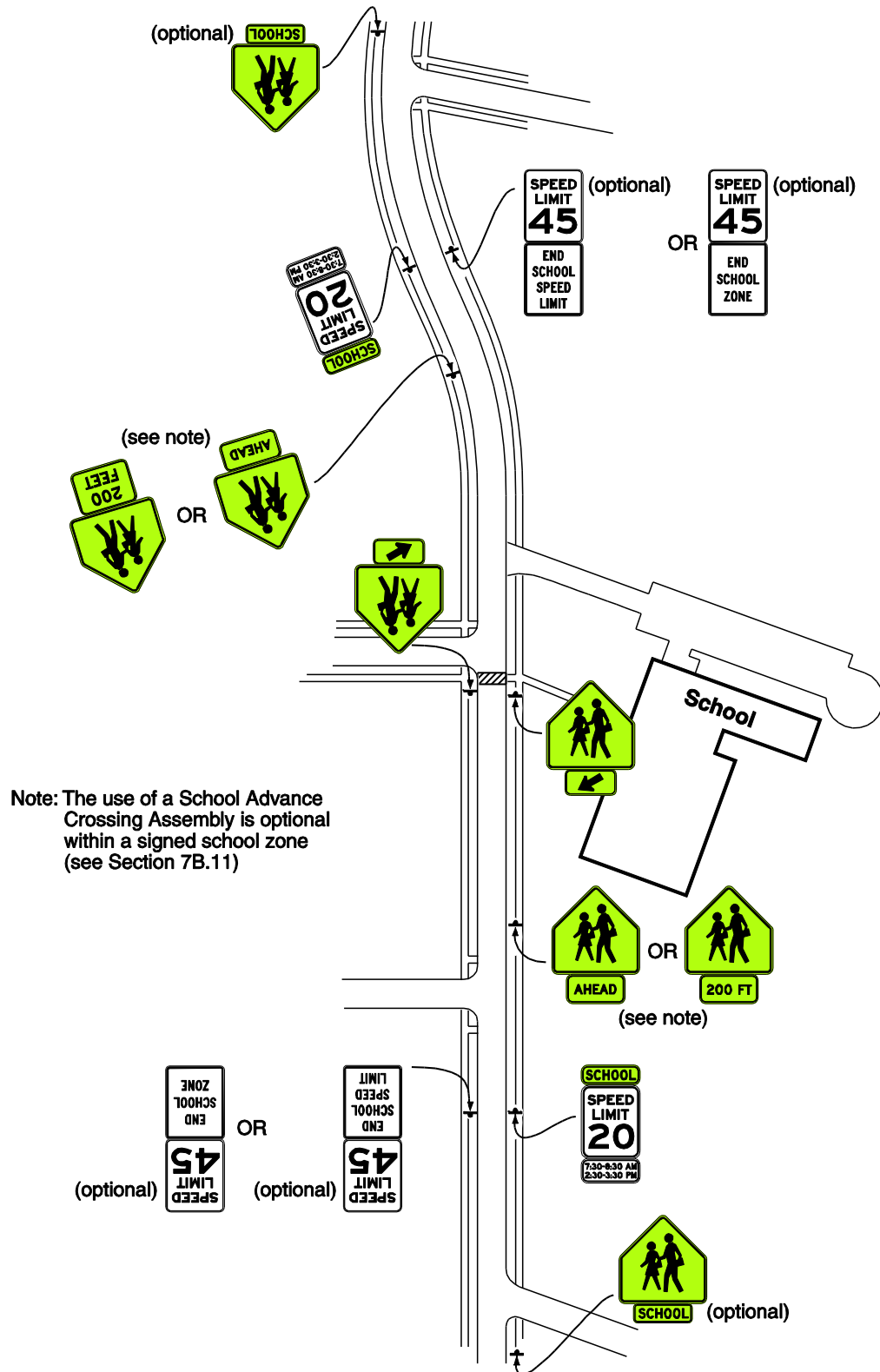
- 07 A 12-inch reduced size in-street School (S1-1) sign (see [Figure 7B-6\(VA\) in this Supplement](#)) may be used at an unsignalized school crossing instead of the In-Street Pedestrian Crossing (R1-6) or the In-Street Schoolchildren Crossing (R1-6b) sign. A 12 x 6-inch reduced size diagonal downward pointing arrow (W16-7P) plaque may be mounted below the reduced size in-street School (S1-1) sign.

### Standard:

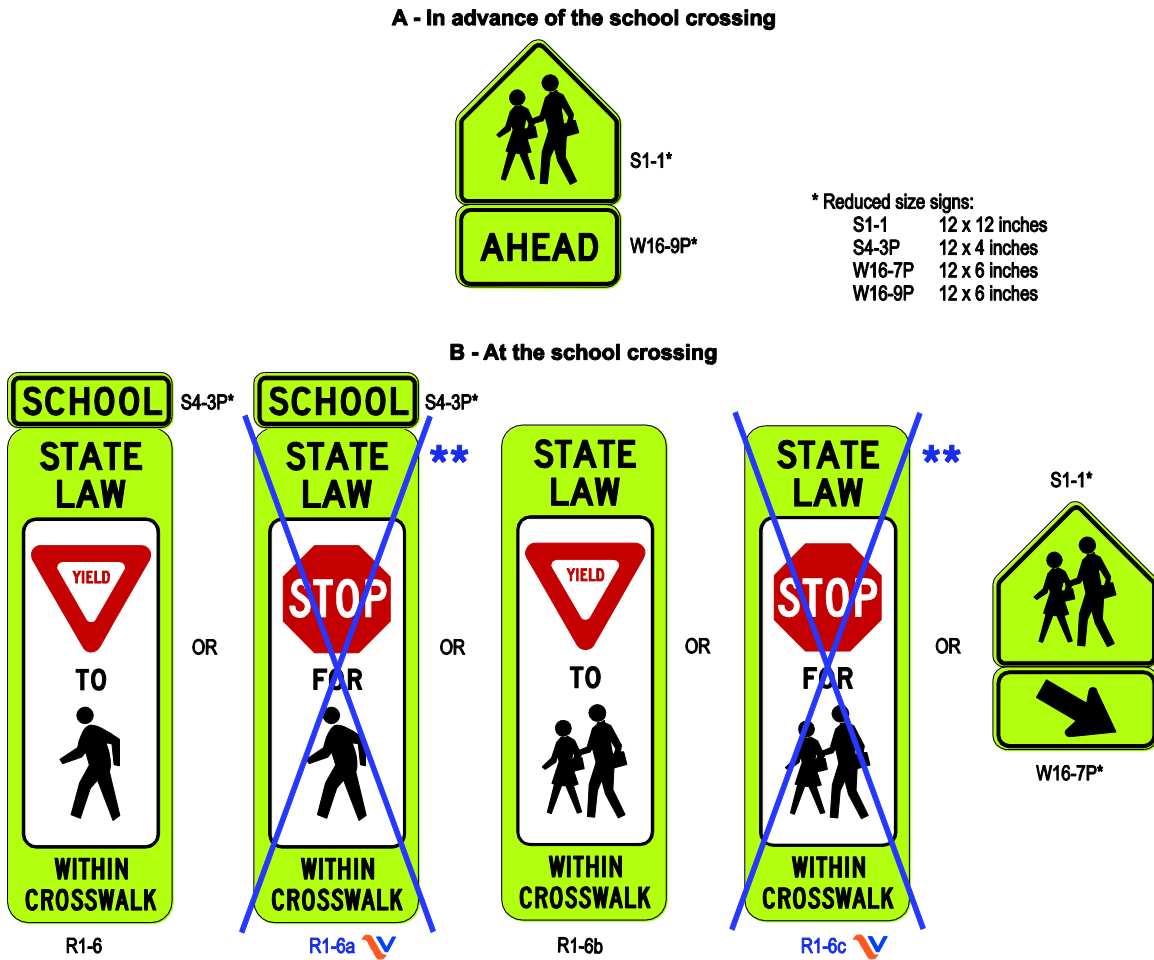
- 08 **If an In-Street Pedestrian Crossing sign, an In-Street Schoolchildren Crossing sign, or a reduced size in-street School (S1-1) sign is placed in the roadway, the sign support shall comply with the mounting height and special mounting support requirements for In-Street Pedestrian Crossing (R1-6) signs (see Section 2B.12 of this Supplement).**
- 09 **The In-Street Pedestrian Crossing sign, the In-Street Schoolchildren Crossing sign, the Overhead Pedestrian Crossing sign, and the reduced size in-street School (S1-1) sign shall not be used at signalized locations.**



**Figure 7B-5. Example of Signing for a School Zone with a School Speed Limit and a School Crossing**



**Figure 7B-6(VA). In-Street Signs in School Areas**



**Notes:**

1. The use of the STATE LAW legend is optional on the R1-6 series signs (see Section 7B.12).
  2. The use of the SCHOOL plaque above the R1-6 and R1-6a signs is optional.
- \*\*** The R1-6a and R1-6c signs shall not be used in Virginia, as the Virginia code requires drivers to yield to pedestrians.

**Section 7B.16 Reduced School Speed Limit Ahead Sign (S4-5, S4-5a)**

*Guidance:*



- 01 *A Reduced School Speed Limit Ahead (S4-5) sign (see Figure 7B-1(VA) in this Supplement) should be used to inform road users of a reduced speed zone where the speed limit is being reduced by more than 10 mph, or where engineering judgment indicates that advance notice would be appropriate. If used, the symbolic Reduced School Speed Limit Ahead (S4-5) sign should be used and the text Reduced School Speed Limit Ahead sign (S4-5a) sign should not be used.*



**Standard:**

- 02 **If used, the Reduced School Speed Limit Ahead sign shall be followed by a School Speed Limit sign or a School Speed Limit assembly.**
- 03 **The speed limit displayed on the Reduced School Speed Limit Ahead sign shall be identical to the speed limit displayed on the subsequent School Speed Limit sign or School Speed Limit assembly.**

**Section 7B.17 Parking and Stopping Signs (R7 and R8 Series)****Option:**

- 01 Parking and stopping regulatory signs may be used to prevent parked or waiting vehicles from blocking pedestrians' views, and drivers' views of pedestrians, and to control vehicles as a part of the school traffic plan.

**Support:**

- 02 Parking signs and other signs governing the stopping and standing of vehicles in school areas cover a wide variety of regulations. Typical examples of regulations are as follows:
  - A. No Parking X:XX AM to X:XX PM School Days Only,
  - B. No Stopping X:XX AM to X:XX PM School Days Only,
  - C. XX Min Loading X:XX AM to X:XX PM School Days Only, and
  - D. No Standing X:XX AM to X:XX PM School Days Only.
- 03 Section 2B.46 of this Supplement and Sections 2B.47 and 2B.48 of the MUTCD contain information regarding the signing of parking regulations in school zone areas.

**Guidance:**

- 04 *STATE LAW STOP FOR SCHOOL BUS LOADING OR UNLOADING CHILDREN (S0-V1) signs (see Figure 7B-V1 in this Supplement) should be installed on undivided highways where engineering judgement indicates a need to inform and remind motorists that they shall not pass - from any direction - a school bus that is loading or unloading children.*
- 05 *Signs should be installed at or near state boundaries, leaving the corporate limits of a city or town, and at other locations where engineering judgment determines they are necessary.*

**Support:**

- 06 The STATE LAW STOP FOR SCHOOL BUS LOADING OR UNLOADING CHILDREN (S0-V1) signs are installed in accordance with the Code of Virginia § 46.2-859.





**Figure 7B-V1. Stop for School Bus Loading or Unloading Children Sign**



S0-V1

## **PART 8. TRAFFIC CONTROL FOR RAILROAD AND LIGHT RAIL TRANSIT GRADE CROSSINGS**

<b>CHAPTER 8A. GENERAL</b>	<b>PAGE</b>
Section 8A.01	Introduction
Section 8A.02	Use of Standard Devices, Systems, and Practices at Highway-Rail Grade Crossings
Section 8A.03	Use of Standard Devices, Systems, and Practices at Highway-LRT Grade Crossings
Section 8A.04	Uniform Provisions
Section 8A.05	Grade Crossing Elimination
Section 8A.06	Illumination at Grade Crossings
Section 8A.07	Quiet Zone Treatments at Highway-Rail Grade Crossings
Section 8A.08	Temporary Traffic Control Zones
<hr/>	
<b>CHAPTER 8B SIGNS AND MARKINGS</b>	<b>PAGE</b>
Section 8B.01	Purpose
Section 8B.02	Sizes of Grade Crossing Signs .....8-1
Section 8B.03	Grade Crossing (Crossbuck) Sign (R15-1) and Number of Tracks Plaque (R15-2P) at Active and Passive Grade Crossings
Section 8B.04	Crossbuck Assemblies with YIELD or STOP Signs at Passive Grade Crossings
Section 8B.05	Use of STOP (R1-1) or YIELD (R1-2) Signs without Crossbuck Signs at Highway-LRT Grade Crossings
Section 8B.06	Grade Crossing Advance Warning Signs (W10 Series) .....8-4
Section 8B.07	EXEMPT Grade Crossing Plaques (R15-3P, W10-1aP)
Section 8B.08	Turn Restrictions During Preemption
Section 8B.09	DO NOT STOP ON TRACKS Sign (R8-8)
Section 8B.10	TRACKS OUT OF SERVICE Sign (R8-9)
Section 8B.11	STOP HERE WHEN FLASHING Signs (R8-10, R8-10a)
Section 8B.12	STOP HERE ON RED Signs (R10-6, R10-6a)
Section 8B.13	Light Rail Transit Only Lane Signs (R15-4 Series)
Section 8B.14	Do Not Pass Light Rail Transit Signs (R15-5, R15-5a)
Section 8B.15	No Motor Vehicles On Tracks Signs (R15-6, R15-6a)
Section 8B.16	Divided Highway with Light Rail Transit Crossing Signs (R15-7 Series)
Section 8B.17	LOOK Sign (R15-8)
Section 8B.18	Emergency Notification Sign (I-13)
Section 8B.19	Light Rail Transit Approaching-Activated Blank-Out Warning Sign (W10-7)
Section 8B.20	TRAINS MAY EXCEED 80 MPH Sign (W10-8)

Section 8B.21	NO TRAIN HORN Sign or Plaque (W10-9, W10-9P)
Section 8B.22	NO GATES OR LIGHTS Plaque (W10-13P)
Section 8B.23	Low Ground Clearance Grade Crossing Sign (W10-5)
Section 8B.24	Storage Space Signs (W10-11, W10-11a, W10-11b)
Section 8B.25	Skewed Crossing Sign (W10-12)
Section 8B.26	Light Rail Transit Station Sign (I-12)
Section 8B.27	Pavement Markings
Section 8B.28	Stop and Yield Lines
Section 8B.29	Dynamic Envelope Markings

**CHAPTER 8C. FLASHING-LIGHT SIGNALS, GATES, AND TRAFFIC CONTROL SIGNALS PAGE**

Section 8C.01	Introduction
Section 8C.02	Flashing-Light Signals
Section 8C.03	Flashing-Light Signals at Highway-LRT Grade Crossings
Section 8C.04	Automatic Gates
Section 8C.05	Use of Automatic Gates at LRT Grade Crossings
Section 8C.06	Four-Quadrant Gate Systems
Section 8C.07	Wayside Horn Systems
Section 8C.08	Rail Traffic Detection
Section 8C.09	Traffic Control Signals at or Near Highway-Rail Grade Crossings
Section 8C.10	Traffic Control Signals at or Near Highway-LRT Grade Crossings
Section 8C.11	Use of Traffic Control Signals for Control of LRT Vehicles at Grade Crossings
Section 8C.12	Grade Crossings Within or In Close Proximity to Circular Intersections
Section 8C.13	Pedestrian and Bicycle Signals and Crossings at LRT Grade Crossings

**CHAPTER 8D. PATHWAY GRADE CROSSINGS PAGE**

Section 8D.01	Purpose
Section 8D.02	Use of Standard Devices, Systems, and Practices
Section 8D.03	Pathway Grade Crossing Signs and Markings
Section 8D.04	Stop Lines, Edge Lines, and Detectable Warnings
Section 8D.05	Passive Devices for Pathway Grade Crossings
Section 8D.06	Active Traffic Control Systems for Pathway Grade Crossings

# PART 8

## TRAFFIC CONTROL FOR RAILROAD AND LIGHT RAIL TRANSIT GRADE CROSSINGS

### CHAPTER 8B. SIGNS AND MARKINGS

#### Section 8B.02 Sizes of Grade Crossing Signs

**Standard:**

- 01 The sizes of grade crossing signs shall be as shown in [Table 8B-1\(VA\) in this Supplement](#).


**Option:**

- 02 Signs larger than those shown in [Table 8B-1\(VA\) in this Supplement](#) may be used (see [Section 2A.11 of this Supplement](#)).

**Table 8B-1(VA). Grade Crossing Sign and Plaque Minimum Sizes**

Sign or Plaque	Sign Designation	Section	Conventional Road		Expressway	Minimum	Oversized
			Single Lane	Multi-Lane			
Stop	R1-1	8B.04, 8B.05	30 x 30	36 x 36	36 x 36	—	48 x 48
Yield	R1-2	8B.04, 8B.05	36 x 36 x 36	48 x 48 x 48	48 x 48 x 48	30 x 30 x 30	—
No Right Turn Across Tracks	R3-1a	8B.08	24 x 30	30 x 36	—	—	—
No Left Turn Across Tracks	R3-2a	8B.08	24 x 30	30 x 36	—	—	—
Do Not Stop on Tracks	R8-8	8B.09	24 x 30	24 x 30	36 x 48	—	36 x 48
Tracks Out of Service	R8-9	8B.10	24 x 24	24 x 24	36 x 36	—	36 x 36
Stop Here When Flashing	R8-10	8B.11	24 x 36	24 x 36	—	—	36 x 48
Stop Here When Flashing	R8-10a	8B.11	24 x 30	24 x 30	—	—	36 x 42
Stop Here on Red	R10-6	8B.12	24 x 36	24 x 36	—	—	36 x 48
Stop Here on Red	R10-6a	8B.12	24 x 30	24 x 30	—	—	36 x 42

Sign or Plaque	Sign Designation	Section	Conventional Road		Expressway	Minimum	Oversized
			Single Lane	Multi-Lane			
Grade Crossing (Crossbuck)	R15-1	8B.03	48 x 9	48 x 9	—	—	—
Number of Tracks (plaque)	R15-2P	8B.03	27 x 18	27 x 18	—	—	—
Exempt (plaque)	R15-3P	8B.07	24 x 12	24 x 12	—	—	—
Light Rail Only Right Lane	R15-4a	8B.13	24 x 30	24 x 30	—	—	—
Light Rail Only Left Lane	R15-4b	8B.13	24 x 30	24 x 30	—	—	—
Light Rail Only Center Lane	R15-4c	8B.13	24 x 30	24 x 30	—	—	—
Light Rail Do Not Pass	R15-5	8B.14	24 x 30	24 x 30	—	—	—
Do Not Pass Stopped Train	R15-5a	8B.14	24 x 30	24 x 30	—	—	—
No Motor Vehicles On Tracks Symbol	R15-6	8B.15	24 x 24	24 x 24	—	—	—
Do Not Drive On Tracks	R15-6a	8B.15	24 x 30	24 x 30	—	—	—
Light Rail Divided Highway Symbol	R15-7	8B.16	24 x 24	24 x 24	—	—	—
Light Rail Divided Highway Symbol (T-Intersection)	R15-7a	8B.16	24 x 24	24 x 24	—	—	—
Look	R15-8	8B.17	36 x 18	36 x 18	—	—	—
Grade Crossing Advance Warning	W10-1	8B.06	36 Dia.	36 Dia.	48 Dia.	—	48 Dia.
Exempt (plaque)	W10-1aP	8B.07	24 x 12	24 x 12	—	—	—
Grade Crossing and Intersection Advance Warning	W10-2,3,4	8B.06	36 x 36	36 x 36	48 x 48	—	48 x 48
Low Ground Clearance	W10-5	8B.23	36 x 36	36 x 36	48 x 48	—	48 x 48
Low Ground Clearance (plaque)	W10-5P	8B.23	30 x 24	30 x 24	—	—	—

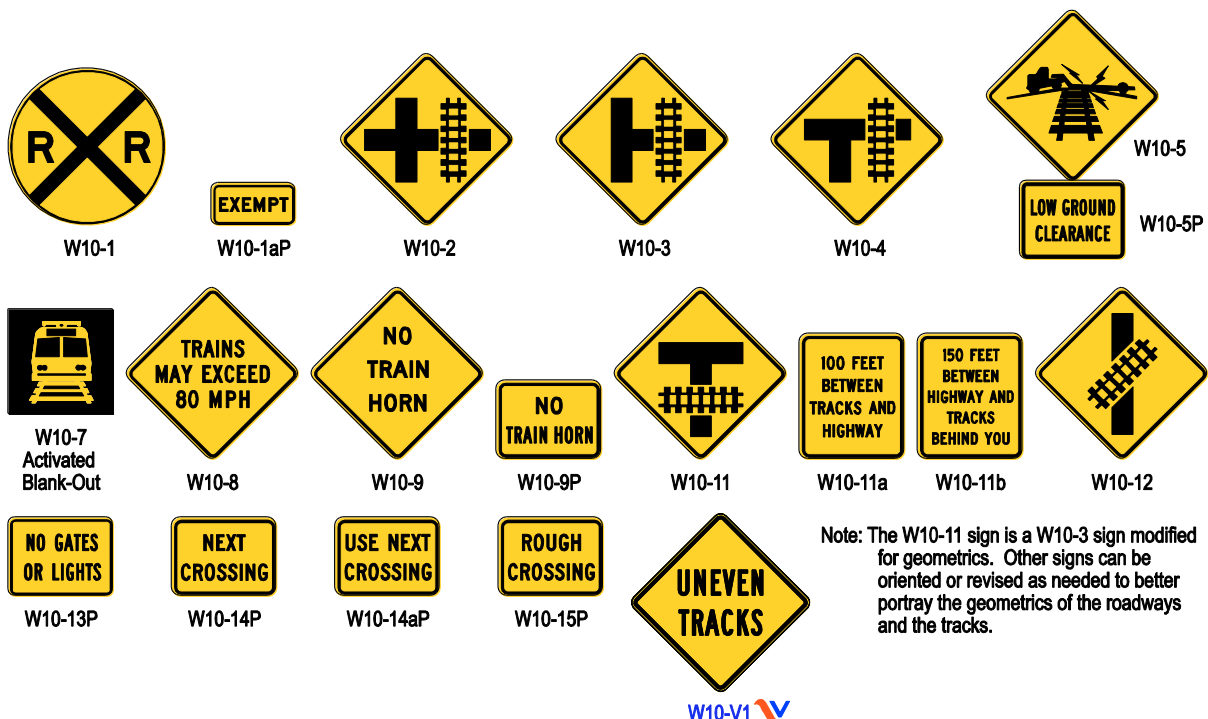
Sign or Plaque	Sign Designation	Section	Conventional Road		Expressway	Minimum	Oversized
			Single Lane	Multi-Lane			
Light Rail Activated Blank-Out Symbol	W10-7	8B.19	24 x 24	24 x 24	—	—	—
Trains May Exceed 80 MPH	W10-8	8B.20	36 x 36	36 x 36	48 x 48	—	48 x 48
No Train Horn	W10-9	8B.21	36 x 36	36 x 36	48 x 48	—	48 x 48
No Train Horn (plaque)	W10-9P	8B.21	30 x 24	30 x 24	—	—	—
Storage Space Symbol	W10-11	8B.24	36 x 36	36 x 36	48 x 48	—	48 x 48
Storage Space XX Feet Between Tracks & Highway	W10-11a	8B.24	30 x 36	30 x 36	—	—	—
Storage Space XX Feet Between Highway & Tracks Behind You	W10-11b	8B.24	30 x 36	30 x 36	—	—	—
Skewed Crossing	W10-12	8B.25	36 x 36	36 x 36	48 x 48	—	48 x 48
No Gates or Lights (plaque)	W10-13P	8B.22	30 x 24	30 x 24	—	—	—
Next Crossing (plaque)	W10-14P	8B.23	30 x 24	30 x 24	—	—	—
Use Next Crossing (plaque)	W10-14aP	8B.23	30 x 24	30 x 24	—	—	—
Rough Crossing (plaque)	W10-15P	8B.23	30 x 24	30 x 24	—	—	36 x 30
 <b>Virginia Specific Signs</b>							
UNEVEN TRACKS	W10-V1	8B.06	36 x 36	36 x 36	36 x 36	—	48 x 48
<p>Notes:</p> <ol style="list-style-type: none"> <li>1. Larger signs may be used when appropriate.</li> <li>2. Dimensions in inches are shown as width x height.</li> <li>3. Table 9B-1 shows the minimum sizes that may be used for grade crossing signs and plaques that face shared-use paths and pedestrian facilities.</li> </ol>							

## Section 8B.06 Grade Crossing Advance Warning Signs (W10 Series)

### Standard:

- 01 A Highway-Rail Grade Crossing Advance Warning (W10-1) sign (see [Figure 8B-4\(VA\) in this Supplement](#)) shall be used on each highway in advance of every highway-rail grade crossing, and every highway-LRT grade crossing in semi-exclusive alignments, except in the following circumstances:
- On an approach to a grade crossing from a T-intersection with a parallel highway if the distance from the edge of the track to the edge of the parallel roadway is less than 100 feet and W10-3 signs are used on both approaches of the parallel highway;
  - On low-volume, low-speed highways crossing minor spurs or other tracks that are infrequently used and road users are directed by an authorized person on the ground to not enter the crossing at all times that approaching rail traffic is about to occupy the crossing;
  - In business or commercial areas where active grade crossing traffic control devices are in use; or
  - Where physical conditions do not permit even a partially effective display of the sign.

**Figure 8B-4(VA). Warning Signs and Plaques for Grade Crossings**





- 02 **The placement of the Grade Crossing Advance Warning sign shall be in accordance with Section 2C.05 of the MUTCD and Table 2C-4.**
- 03 **A Yield Ahead (W3-2) or Stop Ahead (W3-1) Advance Warning sign (see Figure 2C-6(VA) in this Supplement) shall also be installed if the criteria for their installation given in Section 2C.36 of the MUTCD is met. If a Yield Ahead or Stop Ahead sign is installed on the approach to the crossing, the W10-1 sign shall be installed upstream from the Yield Ahead or Stop Ahead sign. The Yield Ahead or Stop Ahead sign shall be located in accordance with Table 2C-4. The minimum distance between the signs shall be in accordance with Section 2C.05 of the MUTCD and Table 2C-4.**

**Option:**

- 04 On divided highways and one-way streets, an additional W10-1 sign may be installed on the left-hand side of the roadway.

**Standard:**

- 05 **If the distance between the tracks and a parallel highway, from the edge of the tracks to the edge of the parallel roadway, is less than 100 feet, W10-2, W10-3, or W10-4 signs (see Figure 8B-4(VA) in this Supplement) shall be installed on each approach of the parallel highway to warn road users making a turn that they will encounter a grade crossing soon after making a turn, and a W10-1 sign for the approach to the tracks shall not be required to be between the tracks and the parallel highway.**
- 06 **If the W10-2, W10-3, or W10-4 signs are used, sign placement in accordance with the guidelines for Intersection Warning signs in Table 2C-4 using the speed of through traffic shall be measured from the highway intersection.**

*Guidance:*

- 07 *If the distance between the tracks and the parallel highway, from the edge of the tracks to the edge of the parallel roadway, is 100 feet or more, a W10-1 sign should be installed in advance of the grade crossing, and the W10-2, W10-3, or W10-4 signs should not be used on the parallel highway.*
- 08 *The UNEVEN TRACKS (W10-V1) sign (see Figure 8B-4(VA) in this Supplement) should be installed at rail sidings or other rail crossings of varying elevations which may constitute a hazard to vehicles crossing at normal speeds.*



## PART 9 TRAFFIC CONTROL FOR BICYCLE FACILITIES

<b>CHAPTER 9A. GENERAL</b>	<b>PAGE</b>
Section 9A.01 Requirements for Bicyclist Traffic Control Devices	
Section 9A.02 Scope	
Section 9A.03 Definitions Relating to Bicycles	
Section 9A.04 Maintenance	
Section 9A.05 Relation to Other Documents	
Section 9A.06 Placement Authority	
Section 9A.07 Meaning of Standard, Guidance, Option, and Support	
Section 9A.08 Colors	
<b>CHAPTER 9B. SIGNS</b>	<b>PAGE</b>
Section 9B.01 Application and Placement of Signs .....	9-1
Section 9B.02 Design of Bicycle Signs	
Section 9B.03 STOP and YIELD Signs (R1-1, R1-2) .....	9-2
Section 9B.04 Bike Lane Signs and Plaques (R3-17, R3-17aP, R3-17bP)	
Section 9B.05 BEGIN RIGHT TURN LANE YIELD TO BIKES Sign (R4-4)	
Section 9B.06 Bicycles May Use Full Lane Sign (R4-11) .....	9-4
Section 9B.07 Bicycle WRONG WAY Sign and RIDE WITH TRAFFIC Plaque (R5-1b, R9-3cP)	
Section 9B.08 NO MOTOR VEHICLES Sign (R5-3)	
Section 9B.09 Selective Exclusion Signs	
Section 9B.10 No Parking Bike Lane Signs (R7-9, R7-9a)	
Section 9B.11 Bicycle Regulatory Signs (R9-5, R9-6, R10-4, R10-24, R10-25, and R10-26)	
Section 9B.12 Shared-Use Path Restriction Sign (R9-7)	
Section 9B.13 Bicycle Signal Actuation Sign (R10-22)	
Section 9B.14 Other Regulatory Signs	
Section 9B.15 Turn or Curve Warning Signs (W1 Series)	
Section 9B.16 Intersection Warning Signs (W2 Series)	
Section 9B.17 Bicycle Surface Condition Warning Sign (W8-10)	
Section 9B.18 Bicycle Warning and Combined Bicycle/Pedestrian Signs (W11-1 and W11-15) .....	9-5
Section 9B.19 Other Bicycle Warning Signs .....	9-7
Section 9B.20 Bicycle Guide Signs (D1-1b, D1-1c, D1-2b, D1-2c, D1-3b, D1-3c, D11-1, D11-1c)	
Section 9B.21 Bicycle Route Signs (M1-8, M1-8a, M1-9)	
Section 9B.22 Bicycle Route Sign Auxiliary Plaques	
Section 9B.23 Bicycle Parking Area Sign (D4-3)	

Section 9B.24	Reference Location Signs (D10-1 through D10-3) and Intermediate Reference Location Signs (D10-1a through D10-3a)
Section 9B.25	Mode-Specific Guide Signs for Shared-Use Paths (D11-1a, D11-2, D11-3, D11-4)
Section 9B.26	Object Markers

---

**CHAPTER 9C. MARKINGS** **PAGE**

Section 9C.01	Functions of Markings	
Section 9C.02	General Principles	
Section 9C.03	Marking Patterns and Colors on Shared-Use Paths	
Section 9C.04	Markings for Bicycle Lanes .....	9-9
Section 9C.05	Bicycle Detector Symbol	
Section 9C.06	Pavement Markings for Obstructions	
Section 9C.07	Shared Lane Marking .....	9-19

---

**CHAPTER 9D. SIGNALS** **PAGE**

Section 9D.01	Application
Section 9D.02	Signal Operations for Bicycles

# PART 9

## TRAFFIC CONTROL FOR BICYCLE FACILITIES

### CHAPTER 9B. SIGNS

#### Section 9B.01 Application and Placement of Signs

##### Standard:

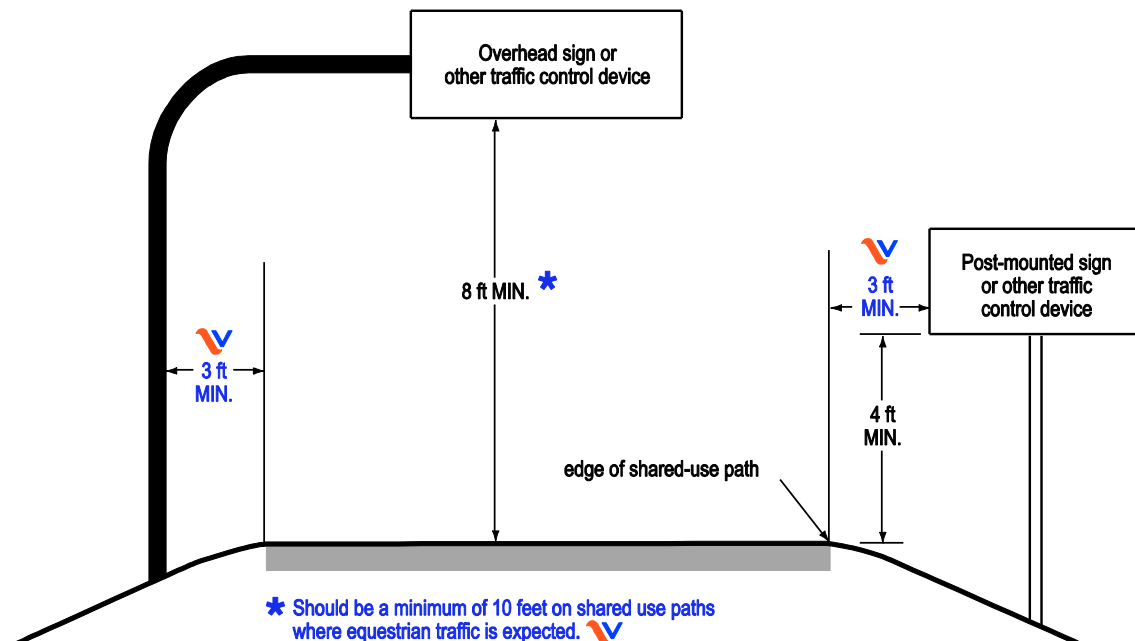
- 01 Bicycle signs shall be standard in shape, legend, and color.
- 02 All signs shall be retroreflectORIZED for use on bikeways, including shared-use paths and bicycle lane facilities.
- 03 Where signs serve both bicyclists and other road users, vertical mounting height and lateral placement shall be as provided in Part 2.
- 04 Where used on a shared-use path, no portion of a sign or its support shall be placed less than ~~2 feet~~ **3 feet\*** laterally from the near edge of the path, or less than 8 feet vertically over the entire width of the shared-use path (see [Figure 9B-1\(VA\) in this Supplement](#)).

##### Guidance:

- 05 Where used on a shared-use path where equestrian traffic is expected, no portion of a sign or its support should be placed less than 10 feet vertically over the entire width of the shared use path (see [Figure 9B-1\(VA\) in this Supplement](#)).

#### Figure 9B-1(VA). Sign Placement on Shared-Use Paths

(This Figure has been updated for the Virginia Supplement to the MUTCD – Revision 1.)\*



**Standard:**

- 06 **Mounting height for post-mounted signs on shared-use paths shall be a minimum of 4 feet, measured vertically from the bottom of the sign to the elevation of the near edge of the path surface (see Figure 9B-1(VA) in this Supplement).**

*Guidance:*

- 07 *Signs for the exclusive use of bicyclists should be located so that other road users are not confused by them.*
- 08 *The clearance for overhead signs on shared-use paths should be adjusted when appropriate to accommodate path users requiring more clearance, such as equestrians, or typical maintenance or emergency vehicles.*

**Section 9B.03 STOP and YIELD Signs (R1-1, R1-2)****Standard:**

- 01 **STOP (R1-1) signs (see Figure 9B-2) shall be installed on shared-use paths at points where bicyclists are required to stop.**
- 02 **YIELD (R1-2) signs (see Figure 9B-2) shall be installed on shared-use paths at points where bicyclists have an adequate view of conflicting traffic as they approach the sign, and where bicyclists are required to yield the right-of-way to that conflicting traffic.**

*Support:*

- 03 *The Code of Virginia, § 46.2-904 states that a person riding a bicycle on a shared use path shall have the same rights and duties as pedestrians. This should be taken into consideration when determining points at which bicycles are required to stop or yield.*

*Option:*

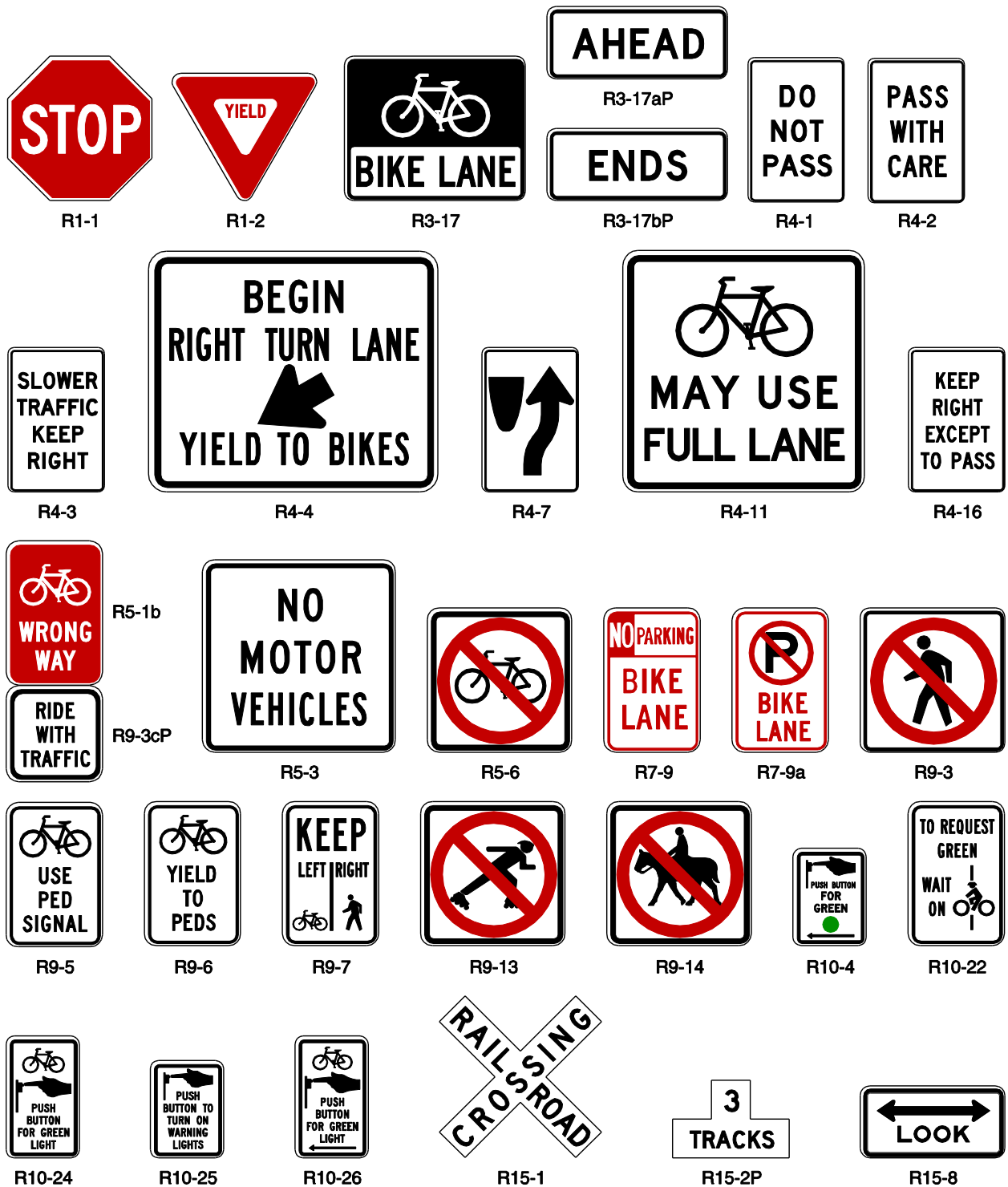
- 04 *A 30 x 30-inch STOP sign or a 36 x 36 x 36-inch YIELD sign may be used on shared-use paths for added emphasis.*

*Guidance:*

- 05 *Where conditions require path users, but not roadway users, to stop or yield, the STOP or YIELD sign should be placed or shielded so that it is not readily visible to road users.*
- 06 *When placement of STOP or YIELD signs is considered, priority at a shared-use path/roadway intersection should be assigned with consideration of the following:*
- A. Relative speeds of shared-use path and roadway users,*
  - B. Relative volumes of shared-use path and roadway traffic, and*
  - C. Relative importance of shared-use path and roadway.*
- 07 *Speed should not be the sole factor used to determine priority, as it is sometimes appropriate to give priority to a high-volume shared-use path crossing a low-volume street, or to a regional shared-use path crossing a minor collector street.*



**Figure 9B-2. Regulatory Signs and Plaques for Bicycle Facilities**



- 08 *When priority is assigned, the least restrictive control that is appropriate should be placed on the lower priority approaches. STOP signs should not be used where YIELD signs would be acceptable.*

## Section 9B.06 Bicycles May Use Full Lane Sign (R4-11)

### Option:

- 01 The Bicycles May Use Full Lane (R4-11) sign (see Figure 9B-2) may be used on roadways where no facilities usable by bicycles exist, such as bicycle lanes, wide curb lanes, or adjacent shoulders, and where travel lanes are too narrow for bicyclists and motor vehicles to operate side by side.\*

### Standard:

- 02 The R4-11 sign shall be used only where "substandard width" lanes make it unsafe for a bicyclist to travel along the right curb or edge of the roadway.\*

### Support:

- 03 The Code of Virginia, § 46.2-905, item 3, allows bicyclists not to ride as close as safely practical to the curb or right hand edge of the roadway when "substandard width" lanes make is unsafe to continue along the right curb or edge.\*
- 04 The Uniform Vehicle Code (UVC) defines a "substandard width lane" as a "lane that is too narrow for a bicycle and a vehicle to travel safely side by side within the same lane."\*

### Option:

- 0501 The Bicycles May Use Full Lane sign may be used in locations where it is important to inform road users that bicyclists might occupy the center of the travel lane.
- 0602 Section 9C.07 of the MUTCD this Supplement\* describes a Shared Lane Marking that may be used in addition to or instead of the Bicycles May Use Full Lane sign (when used in accordance with the Standard in Paragraph 2.3\*) to inform road users that bicyclists might occupy the travel lane.

### Standard:

- 03 The Bicycles May Use Full Lane (R4-11) sign (see Figure 9B-2) shall only be used on roadways where no on-road bicycle facilities exist, such as bicycle lanes, wide curb lanes, or adjacent paved shoulders usable by bicycles, and where substandard width travel lanes are too narrow for bicyclists and motor vehicles to operate side by side.\*

(The following paragraphs were formerly paragraphs 3 and 4, and have been relocated. The text, as written, is not new.)\*

### Support:

- 04 The Code of Virginia, § 46.2-905, item 3, allows bicyclists not to ride as close as safely practicable to the right curb or edge of the roadway when "substandard width" lanes make is unsafe to continue along the right curb or edge.\*
- 05 The Uniform Vehicle Code (UVC) defines a "substandard width lane" as a "lane that is too narrow for a bicycle and a vehicle to travel safely side by side within the same lane."

**Guidance:**

- 06 *The R4-11 sign should only be used on roadway segments where travel lanes are delineated with longitudinal pavement markings or other methods (the R4-11 sign should not be used on undivided unmarked roadways).\**
- 07 *The R4-11 sign should not be placed on roadways that have a speed limit above 35 mph.\**

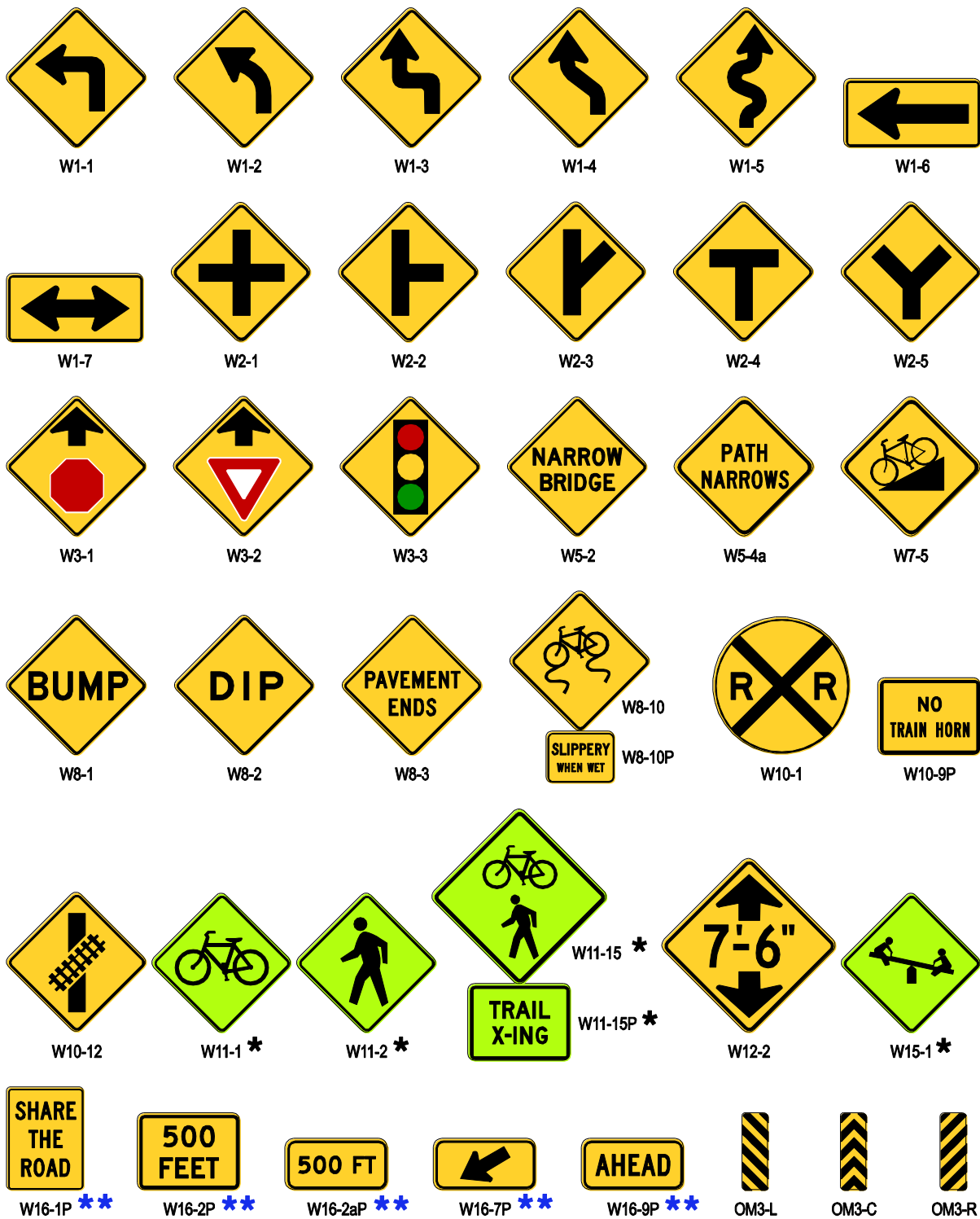
## **Section 9B.18 Bicycle Warning and Combined Bicycle/Pedestrian Signs (W11-1 and W11-15)**

**Support:**

- 01 The Bicycle Warning (W11-1) sign (see [Figure 9B-3\(VA\) in this Supplement](#)) alerts the road user to unexpected entries into the roadway by bicyclists, and other crossing activities that might cause conflicts. These conflicts might be relatively confined, or might occur randomly over a segment of roadway. [See Section 9B.19 of this Supplement for additional information on use of the Bicycle Warning \(W11-1\) sign along with the Share the Road \(W16-1P\) supplemental plaque.](#)



### Figure 9B-3(VA). Warning Signs and Plaques and Object Markers for Bicycle Facilities



\* A fluorescent yellow-green background color *may shall* be used for this sign or plaque.  
 \*\* The background color of the plaque *should shall* match the color of the warning sign that it supplements. 

**Option:**

- 02 The combined Bicycle/Pedestrian (W11-15) sign (see [Figure 9B-3\(VA\) in this Supplement](#)) may be used where both bicyclists and pedestrians might be crossing the roadway, such as at an intersection with a shared-use path. A TRAIL X-ING (W11-15P) supplemental plaque (see [Figure 9B-3\(VA\) in this Supplement](#)) may be mounted below the W11-15 sign.
- 03 A supplemental plaque with the legend AHEAD or XX FEET may be used with the Bicycle Warning or combined Bicycle/Pedestrian sign.

**Guidance:**

- 04 *If used in advance of a specific crossing point, the Bicycle Warning or combined Bicycle/Pedestrian sign should be placed at a distance in advance of the crossing location that conforms with the guidance given in Table 2C-4.*

**Standard:**

- 05 **Bicycle Warning and combined Bicycle/Pedestrian signs, when used at the location of the crossing, shall be supplemented with a diagonal downward pointing arrow (W16-7P) plaque (see [Figure 9B-3\(VA\) in this Supplement](#)) to show the location of the crossing.**
- 06 **A fluorescent yellow-green background color with a black legend and border shall be used for Bicycle Warning and combined Bicycle/Pedestrian signs and supplemental plaques.**

**Guidance:**

- 07 *When the fluorescent yellow-green background color is used, a systematic approach featuring one background color within a zone or area should be used. The mixing of standard yellow and fluorescent yellow-green backgrounds within a zone or area should be avoided.*

## Section 9B.19 Other Bicycle Warning Signs

**Option:**

- 01 Other bicycle warning signs (see [Figure 9B-3\(VA\) in this Supplement](#)) such as PATH NARROWS (W5-4a) and Hill (W7-5) may be installed on shared-use paths to warn bicyclists of conditions not readily apparent.
- 02 In situations where there is a need to warn motorists to watch for bicyclists traveling along the highway, the SHARE THE ROAD (W16-1P) plaque (see [Figure 9B-3\(VA\) in this Supplement](#)) may be used in conjunction with the W11-1 sign.
- 03 The Bicycle Warning Sign (W11-1) and SHARE THE ROAD supplemental plaque (W16-1P) assembly may be considered at the following locations, if observation reflects routine bicycle use:
- Where shared-use paths end at roadways.
  - Where shoulders or wide curb lanes drop prior to features such as narrow bridge or overpasses.

- Where there has been a significant history of bicycle crashes involving vehicles.
  - Where roadway improvements needed to address bicycle safety issues are not practical due to physical or environmental constraints.
- 04 A Bicycle Warning sign (W11-1) and SHARE THE ROAD supplemental plaque (W16-1P) assembly may be considered where all of the following conditions exist:
- A bike lane ends,
  - The speed limit is 40 MPH or greater, and
  - A hazard exists, such as a narrow bridge or overpass, narrow lane, parallel parked vehicles, or a downstream intersection with many turning vehicles. (The end of a bike lane, by itself, is not a hazard.)

**Standard:**

- 05 **A Bicycle Warning sign (W11-1) and SHARE THE ROAD supplemental plaque (W16-1P) assembly shall not be used as a substitute for a bike route sign or where a jurisdiction wants to communicate a general policy statement.**

*Guidance:*

- 06 *If used, other advance bicycle warning signs should be installed at least 50 feet in advance of the beginning of the condition.*
- 07 *Where temporary traffic control zones are present on bikeways, appropriate signs from Part 6 should be used.*

**Option:**

- 08 Other warning signs described in Chapter 2C may be installed on bicycle facilities as appropriate.

*Guidance:*

- 09 *A Bicycle Warning sign (W11-1) and SHARE THE ROAD supplemental plaque (W16-1P) assembly should not be used where a bike lane ends and the speed limit is 35 MPH or less. Such circumstances could include a college or university campus, a central business district, or other area characterized by low speeds and a large amount of interaction between bicycles and motorized vehicles.*

## CHAPTER 9C. MARKINGS

### Section 9C.04 Markings for Bicycle Lanes

Support:



- 01 Pavement markings designate that portion of the roadway for preferential use by bicyclists. Markings inform all road users of the restricted nature of the bicycle lane. Typical pavement marking details are shown in Figure 9C-V1 in this Supplement.

**Standard:**

- 02 **Longitudinal pavement markings shall be used to define bicycle lanes.**

*Guidance:*

- 03 *If used, bicycle lane word, symbol, and/or arrow markings (see Figure 9C-3(VA) in this Supplement) should be placed at the beginning of a bicycle lane and at periodic intervals along the bicycle lane based on engineering judgment.*

**Standard:**



- 04 **Except as provided in Paragraph 5, if bicycle lane markings are used, the helmeted bicyclist symbol marking (see Figures 9C-3(VA) and 9C-V1 in this Supplement) shall be used.**

Option:

- 05 The bike symbol or bike word message may be used to supplement the helmeted bicyclist symbol marking on a limited basis if engineering judgment determines a need for it. Such circumstances include new installations of bike lanes in an area of Virginia where drivers may be less familiar with the meaning of the helmeted bicyclist symbol.

**Standard:**

- 06 **If the bicycle lane symbol marking is used in conjunction with word or arrow messages, it shall precede them.**

Option:

- 07 If the word, symbol, and/or arrow pavement markings shown in Figure 9C-3(VA) in this Supplement are used, Bike Lane signs (see Section 9B.04 of the MUTCD) may also be used, but to avoid overuse of the signs not necessarily adjacent to every set of pavement markings.

**Standard:**

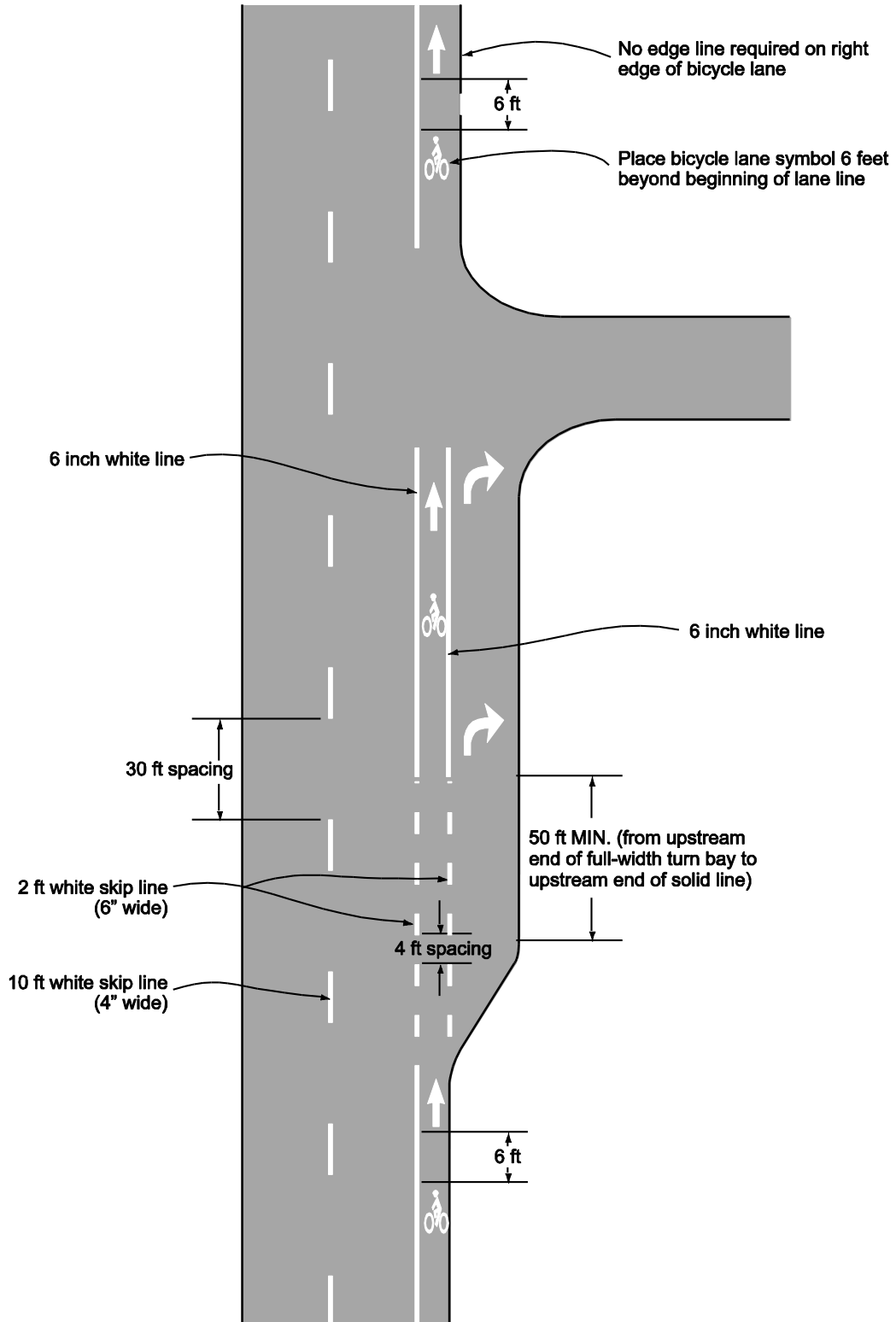
- 08 **A through bicycle lane shall not be positioned to the right of a right turn only lane or to the left of a left turn only lane.**

Support:

- 09 A bicyclist continuing straight through an intersection from the right of a right-turn lane or from the left of a left-turn lane would be inconsistent with normal traffic behavior and would violate the expectations of right- or left-turning motorists.

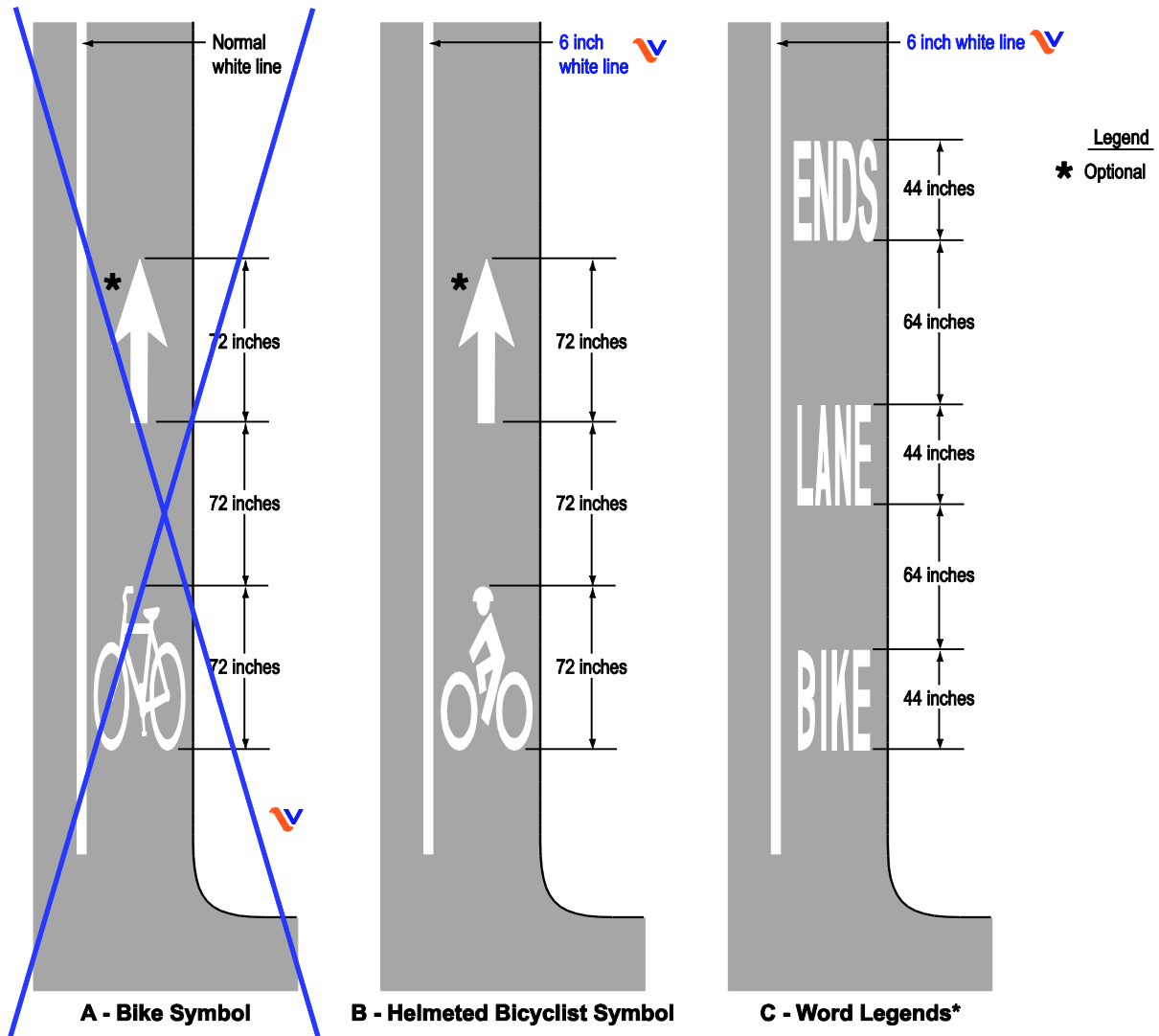


### Figure 9C-V1. VDOT Pavement Marking Standard (Typical Pavement Markings for Bicycle Lane)



## Figure 9C-3(VA). Word, Symbol, and Arrow Pavement Markings for Bicycle Lanes

(This Figure has been updated for the Virginia Supplement to the MUTCD – Revision 1.)\*



Note: Drawing C is for placement details of word legends when used. However, word legends may be utilized in addition to, but not substituting for, the Helmeted Bicyclist symbol which is required.



**Guidance:**

- When the right through lane is dropped to become a right turn only lane, the bicycle lane markings should stop at least ~~100 feet~~ 180 feet (see Figure 9C-V2 in this Supplement)\* before the beginning of the right-turn lane. Through bicycle lane markings should resume to the left of the right turn only lane.

**Support:**

- 11 An example of bicycle lane markings at locations where the right through lane is dropped to become a right turn only lane is shown in Figure 9C-V2 in this Supplement.\*

**Guidance:**

- 1112 An optional through-right turn lane next to a right turn only lane should not be used where there is a through bicycle lane. If a capacity analysis indicates the need for an optional through-right turn lane, the bicycle lane should be discontinued at the intersection approach.
- 1213 Posts or raised pavement markers should not be used to separate bicycle lanes from adjacent travel lanes.

**Support:**

- 1314 Using raised devices creates a collision potential for bicyclists by placing fixed objects immediately adjacent to the travel path of the bicyclist. In addition, raised devices can prevent vehicles turning right from merging with the bicycle lane, which is the preferred method for making the right turn. Raised devices used to define a bicycle lane can also cause problems in cleaning and maintaining the bicycle lane.

**Standard:**

- 1415 **Bicycle lanes shall not be provided on the circular roadway of a roundabout.**

**Guidance:**

- 1516 Bicycle lane markings should stop at least 100 feet before the crosswalk, or if no crosswalk is provided, at least 100 feet before the yield line, or if no yield line is provided, then at least 100 feet before the edge of the circulatory roadway.

**Support:**

- 1617 Examples of bicycle lane markings at right-turn lanes are shown in Figures 9C-1(VA), 9C-4(VA), and 9C-5(VA) in this Supplement. Examples of pavement markings for bicycle lanes on a two-way street are shown in Figure 9C-6(VA) in this Supplement. Pavement word message, symbol, and arrow markings for bicycle lanes are shown in Figure 9C-3(VA) in this Supplement.

**Standard:**

- 1718 **Pavement markings consisting of arrow and bicycle lane symbols shall be placed at the beginning of the bicycle lane at right turn lanes. Markings shall also be placed at the end of the bicycle lane at right turn lanes if the solid white line separating the bicycle lane from the right turn lane is greater than 100 feet in length.**

- 1819 **Bicycle lane symbols shall be placed a maximum of 500 feet apart.**

**Guidance:**

- 1920 The bicycle lane pavement line marking should be a minimum of:

- 4 feet from the edge of pavement on curb and gutter roadways (where the edge\* face of the concrete gutter pan meets the edge of the pavement).
- 5 feet from the edge\* face of a\* curb/pavement\* on roadways without a gutter pan (where the face of the concrete curb meets the edge of pavement).



- ~~5~~ 4\* feet from the edge of the pavement on roadways without curb and gutter (where the edge of asphalt meets the shoulder or roadside).

~~Option:~~

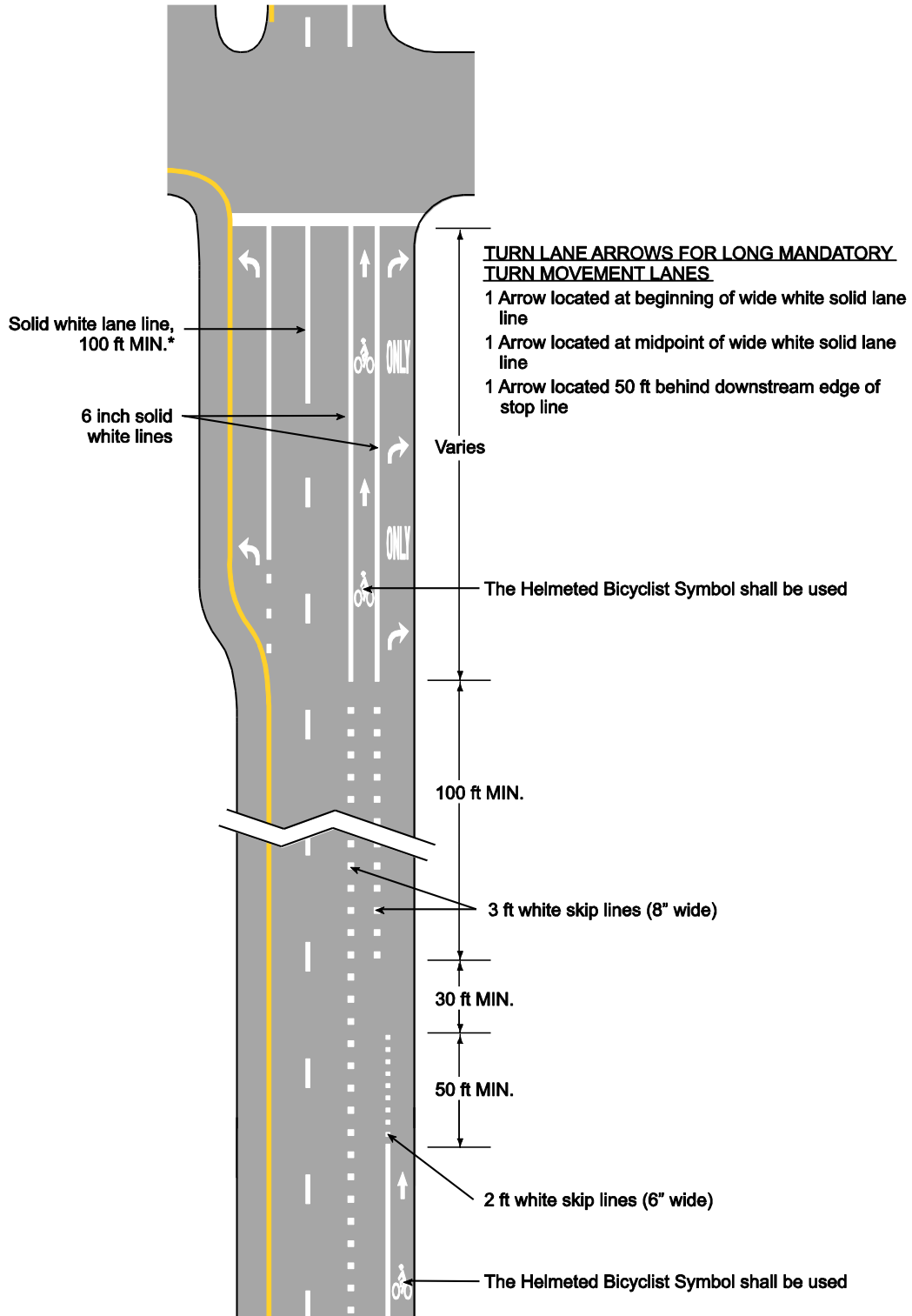
~~20—On asphalt roadways where the bicycle lane is beside curb and gutter and the asphalt portion of the bicycle lane is of insufficient width to allow placement of the bicycle symbol entirely on the asphalt, the symbol may be reduced and sized to fit entirely on the asphalt.\*~~





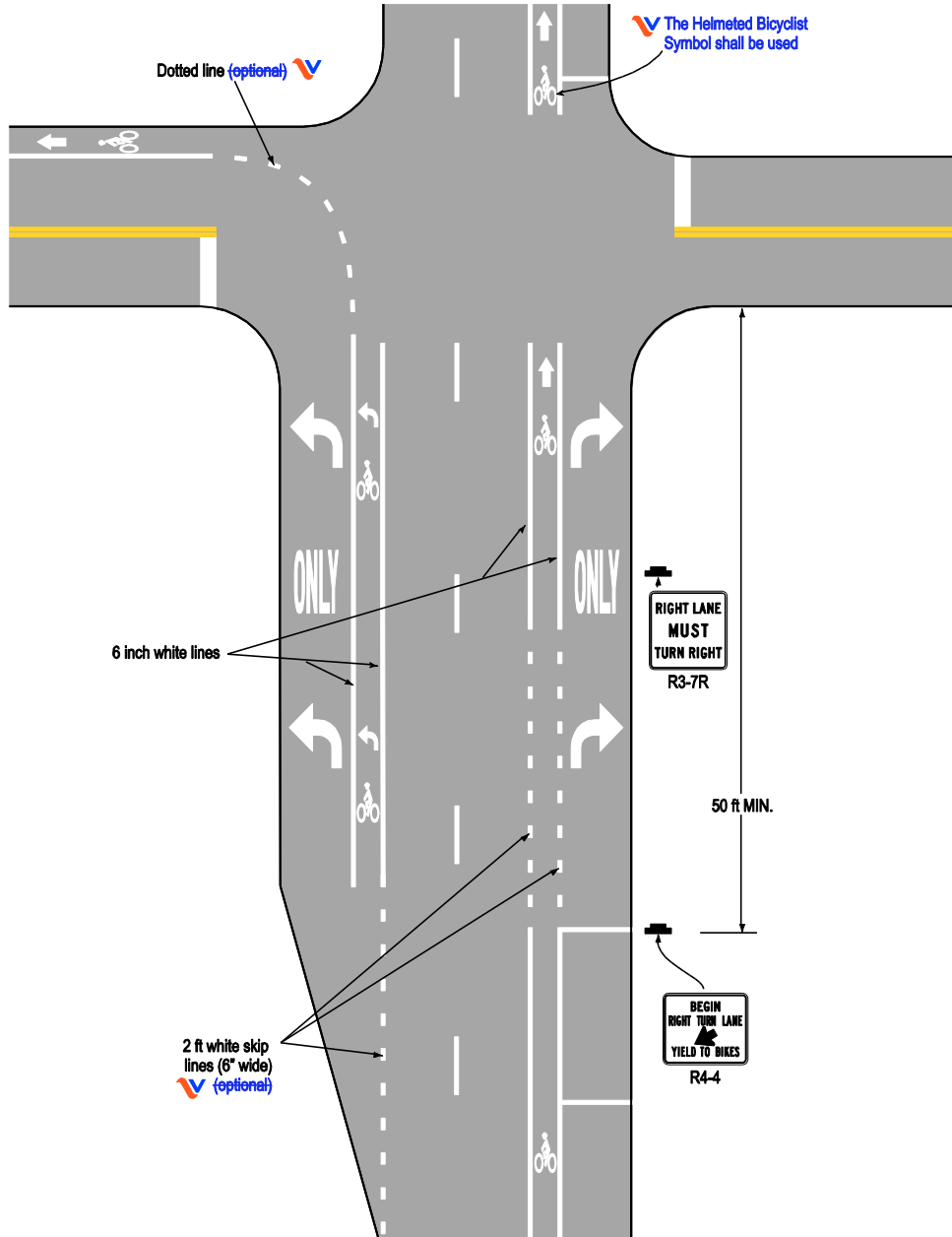
## Figure 9C-V2. Example of Bicycle Lane Markings at a Right Turn Lane Drop at an Intersection \*

(This Figure has been added to the Virginia Supplement to the MUTCD – Revision 1.)\*

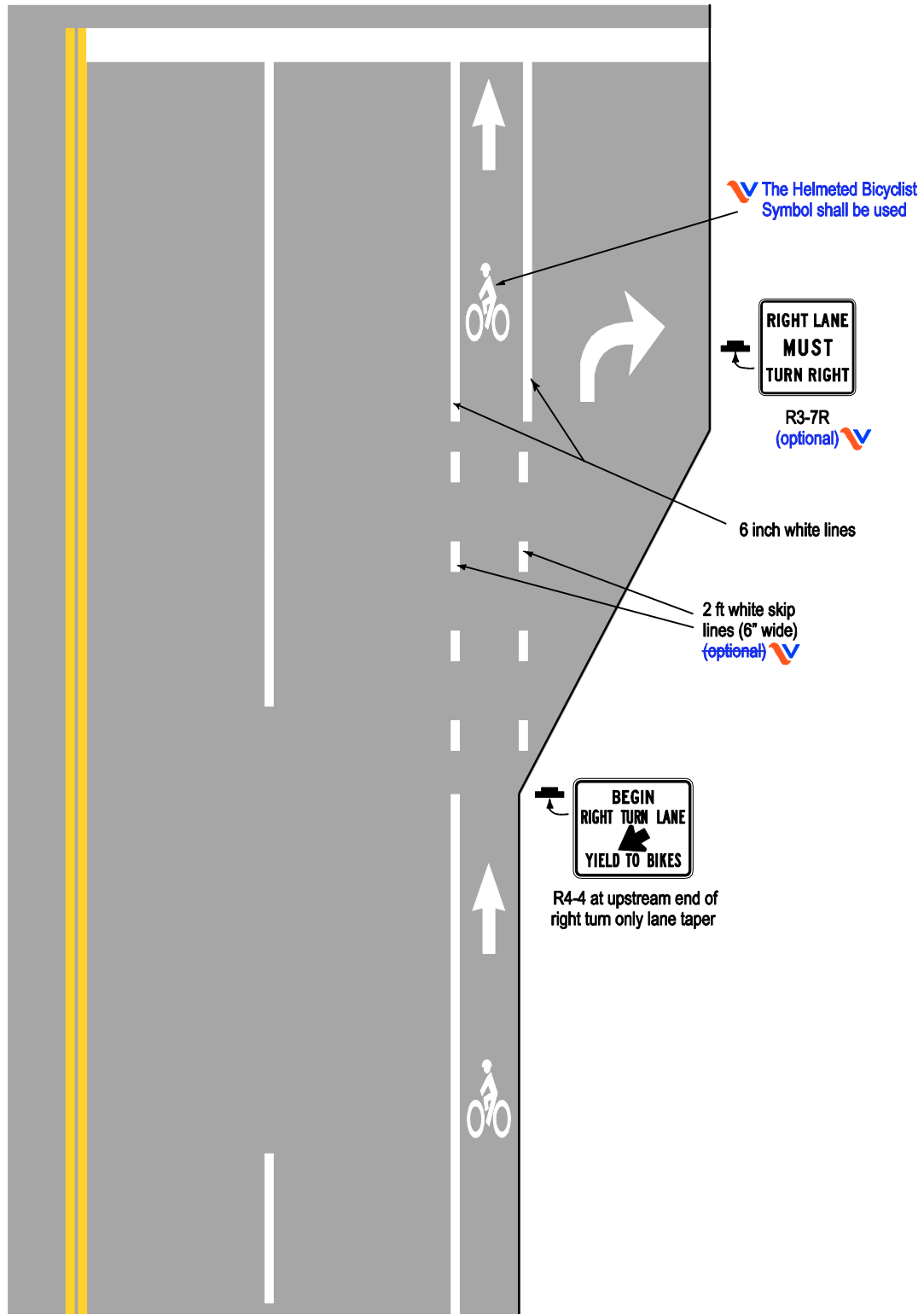


\* Minimums are recommended distances where spacing allows or is feasible

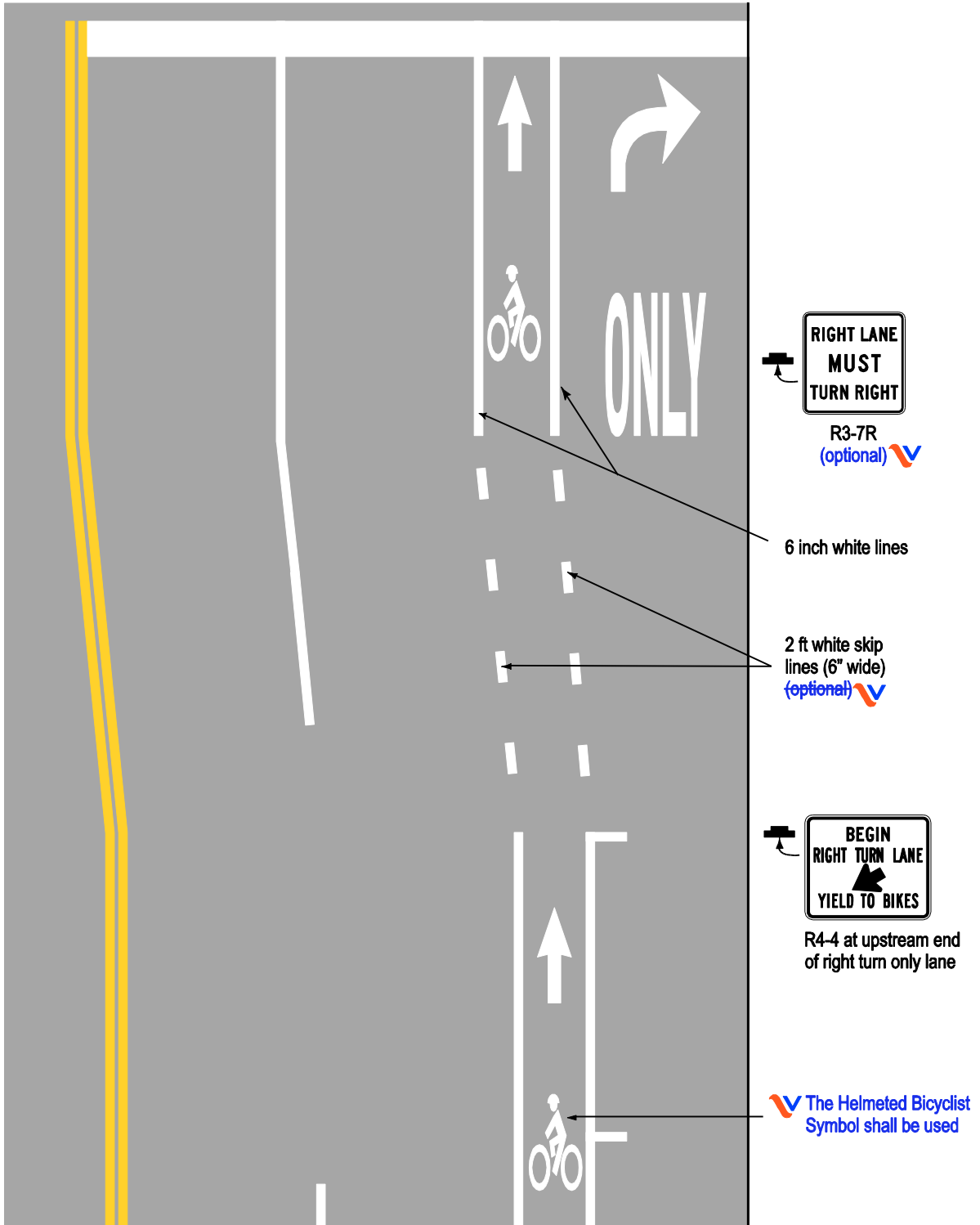
**Figure 9C-1(VA). Example of Intersection Pavement Markings—Designated Bicycle Lane with Left-Turn Area, Heavy Turn Volume, Parking, One-Way Traffic, or Divided Highway**



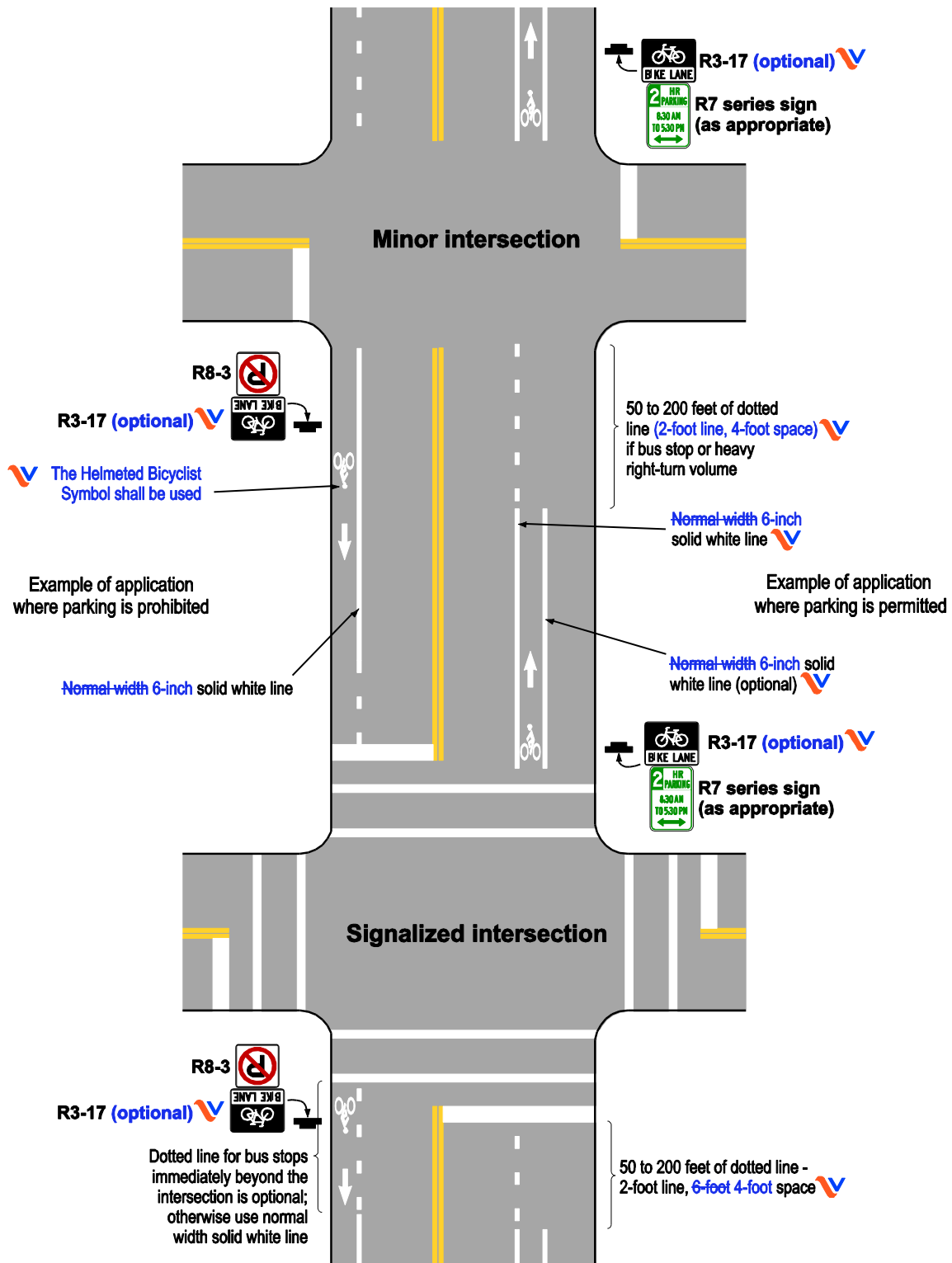
### Figure 9C-4(VA). Example of a Bicycle Lane Treatment at a Right-Turn Only Lane



### Figure 9C-5(VA). Example of Bicycle Lane Treatment at Parking Lane into a Right-Turn Only Lane



### Figure 9C-6(VA). Example of Pavement Markings for Bicycle Lanes on a Two-Way Street



**Option:**

- 21 On asphalt roadways where the bicycle lane is beside curb and gutter and the asphalt portion of the bicycle lane is of insufficient width to allow placement of the bicycle symbol entirely on the asphalt, the symbol may be reduced and sized to fit entirely on the asphalt.\*

**Standard:**

- 2122 If the bicycle symbol is reduced, it shall be reduced to no less than 4 feet in length.

**Support:**

- 2223 Typical bicycle lane pavement marking details are shown in Figure 9C-V1 in this Supplement.

**Section 9C.07 Shared Lane Marking**

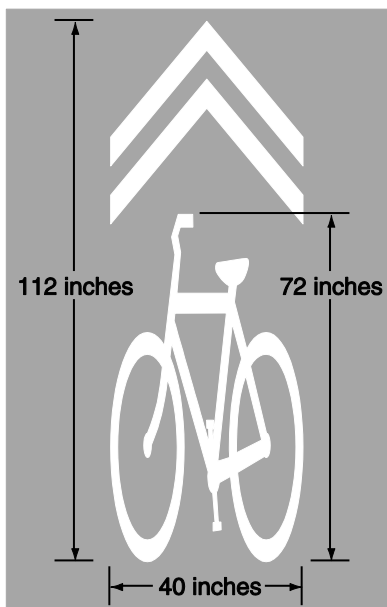
(This Section has been added to the Virginia Supplement to the MUTCD in Revision 1.) \*

**Option:**

- 01 When determined to be an appropriate use, the Shared Lane Marking shown in Figure 9C-9 may be used to address defined safety issues. Specifically, they may be used as follows: \*



**Figure 9C-9. Shared Lane Marking**



- A. To assist bicyclists with lateral positioning in a shared lane with on-street parallel parking in order to reduce the chance of a bicyclist's impacting the open door of a parked vehicle,
- B. To assist bicyclists with lateral positioning in lanes that are too narrow for a motor vehicle and a bicycle to travel side by side within the same traffic lane, \*

- C. To alert road users of the lateral location bicyclists are likely to occupy within the traveled way,
- D. To encourage safe passing of bicyclists by motorists,
- E. To reduce the incidence of wrong-way bicycling, where it is routinely observed,
- F. To indicate more appropriate positioning away from the curb or the edge of the traveled way on wide outside lanes,
- G. At multi-lane intersections where there is insufficient width to provide a bicycle lane, and conflicts make it desirable to indicate proper positioning,
- H. On steep downgrades where bicycle speeds are high and parking is present, since bicyclists may choose not to use a bike lane when traveling at high speeds adjacent to parked vehicles,
- I. Where a bike lane ends and the roadway continues with a posted speed of 35 mph or less, or
- J. In short segments between intermittent segments of bike lanes. \*

**Guidance:**

- 02 *The Shared Lane Marking should not be placed on roadways that have a speed limit above 35 mph. \**

**Standard:**

- 03 **Shared Lane Markings shall not be used: \***

- A. On shoulders or in designated bicycle lanes,
- B. To provide wayfinding guidance to bicyclists,
- C. On a shared-use path or other facility where motor vehicle traffic is prohibited,
- D. As a substitute for bicycle lanes where roadway geometric conditions permit bicycle lanes to be marked, or
- E. In an exclusive turn lane. \*

**Option:**

- 04 Shared Lane Markings approaching an intersection may be used in the right most through-lane next to an exclusive right turn lane to accommodate daily bicycle through movements when there is a designated on-road bicycle lane on the receiving/far side of the intersection to receive the bicycles from the right most through lane. \*

**Guidance:**

- 05 *In order to prevent overuse of the Shared Lane Markings, judgment should be applied that takes into account daily bicycle volumes, daily vehicle volumes, and bicycle-vehicle conflicts; or a documented safety issue. \**
- 06 *If used in a shared lane with on-street parallel parking, Shared Lane Markings should be placed so that the centers of the markings are at least 11 feet from the face of the curb, or from the edge of the pavement where there is no curb. The parking lane width should be considered and the Shared Lane Marking adjusted accordingly. \**
- 07 *If used on a street without on-street parking that has an outside travel lane that is less than 14 feet wide, the centers of the Shared Lane Markings should be at least 4 feet from the face of the curb, or from the edge of the pavement where there is no curb. \**





08 *If used, the Shared Lane Marking should be placed immediately after an intersection and spaced at intervals not greater than 250 feet thereafter.\**

09 *The Shared Lane Marking should only be used on roadway segments where travel lanes are delineated with longitudinal pavement markings or other methods (the Shared Lane Marking should not be used on undivided unmarked roadways).\**

Option:

10 *Section 9B.06 in this Supplement describes a Bicycles May Use Full Lane sign that may be used in addition to or instead of the Shared Lane Marking to inform road users that bicyclists might occupy the travel lane.\**





## APPENDIX A – HOW TO OBTAIN RELATED DOCUMENTS AND WEB RESOURCES

### Support:

- 01 Below is a list of web links to related documents and internet resources that are referenced in this Supplement:
- A. The Code of Virginia - <http://leg1.state.va.us/000/src.htm>
  - B. Code of Virginia definition of Limited Access Highway - <http://leg1.state.va.us/cgi-bin/legp504.exe?000+cod+33.1-57> \*
  - C. Design and Use Policy for Clearview Alphabet - <http://mutcd.fhwa.dot.gov/resources/clearviewdesignfaqs/index.htm> \*
  - BD. Virginia Department of Historical Resources - <http://www.dhr.virginia.gov>
  - CE. Virginia Department of Transportation – <http://www.virginiadot.org>
  - F. Virginia Historical Highway Markers - [http://www.dhr.virginia.gov/hiway\\_markers/hwmarker\\_info.htm](http://www.dhr.virginia.gov/hiway_markers/hwmarker_info.htm) \*
  - DG. VDOT Guidelines for the Installation of In-Roadway Warning Lights - [http://www.virginiadot.org/business/resources/IRWL\\_20Final\\_20Guidelines\\_2012-14-05.pdf](http://www.virginiadot.org/business/resources/IRWL_20Final_20Guidelines_2012-14-05.pdf)
  - EH. VDOT Guidelines for the Installation of Marked Crosswalks - [http://www.virginiadot.org/business/resources/Marked\\_20Crosswalks\\_20Final\\_20Guidelines\\_2012-14-05.pdf](http://www.virginiadot.org/business/resources/Marked_20Crosswalks_20Final_20Guidelines_2012-14-05.pdf)
  - FI. VDOT Highway Safety Corridors - <http://www.virginiadot.org/programs/ct-highway-safety-corridor.asp>
  - GJ. VDOT Road and Bridge Specifications - <http://www.virginiadot.org/business/const/spec-default.asp>
  - HK. VDOT Road and Bridge Standards - [http://www.virginiadot.org/business/locdes/Standards\\_TOC.asp](http://www.virginiadot.org/business/locdes/Standards_TOC.asp)
  - HL. VDOT Road Design Manual – <http://www.virginiadot.org/business/locdes/rdmanual-index.asp>
  - JM. VDOT Traffic Engineering Division Memoranda - [http://www.virginiadot.org/business/traffic\\_engineering\\_memoranda.asp](http://www.virginiadot.org/business/traffic_engineering_memoranda.asp)
  - KN. VDOT Traffic Engineering Design Manual – <http://www.virginiadot.org/business/locdes/traffic-engineering-manual.asp>
  - O. VDOT 2035 Highway Plan (Corridors of Statewide Significance) – [http://www.vtrans.org/2035\\_surface\\_plan.asp](http://www.vtrans.org/2035_surface_plan.asp) \*
  - LP. Virginia Standard Highway Signs Book – ~~{link will be provided upon publication of the Virginia SHS Book}~~ \*  
[http://www.virginiadot.org/business/resources/TED/final\\_MUTCD/Standard\\_Highway\\_Signs\\_Book.pdf](http://www.virginiadot.org/business/resources/TED/final_MUTCD/Standard_Highway_Signs_Book.pdf) \*

MQ. Virginia Work Area Protection Manual – ~~{link will be provided upon publication of the Virginia Work Area Protection Manual}~~\*  
[http://www.virginiadot.org/business/resources/wztc/Virginia\\_WAPM\\_2011\\_web.pdf](http://www.virginiadot.org/business/resources/wztc/Virginia_WAPM_2011_web.pdf)\*

Support:

- 02 Below is a list of documents that are referenced in this Supplement and available through means other than web links:
  - A. Maintenance Division Best Practices Manual – Please submit a written request to:  
Virginia Department of Transportation  
Maintenance Division  
1401 East Broad Street  
Richmond, VA 23219